

aalco[®]

Company Profile

Stainless Steel

Aluminium

Copper, Brass & Bronze

General Data



www.aalco.co.uk

To receive a copy of any of the following literature or to download a pdf version please visit www.aalco.co.uk or contact your local Service Centre. Details on back cover.

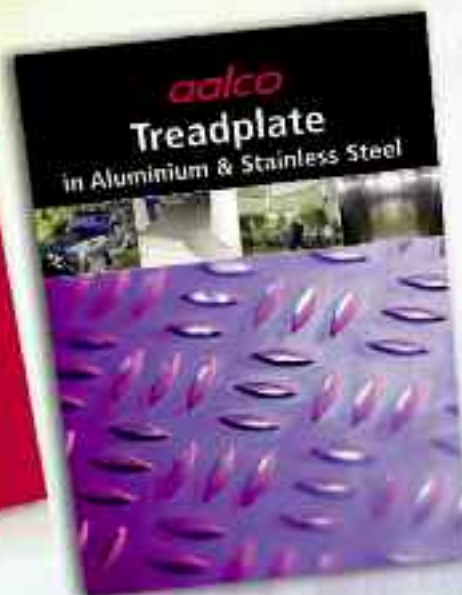
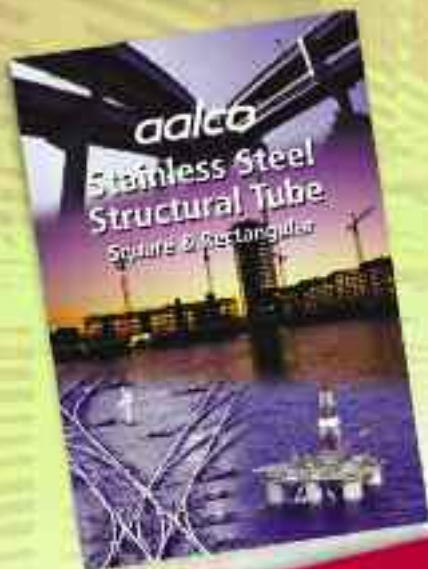

aalco
Metric Tru-Bore™ Stainless Steel Tube & Fittings



The information contained herein is based on our present knowledge and experience and is given in good faith. However, no liability will be accepted by the Company in respect of any action taken by any third party in reliance thereon.

As the products detailed herein may be used for a wide variety of purposes and as the Company has no control over their use, the Company specifically excludes all conditions or warranties expressed or implied by statute or otherwise as to dimensions, properties and/or their fitness for any particular purpose. Any advice given by the Company to any third party is given for that party's assistance only and without any liability on the part of the Company.

Any contract between the Company and a customer will be subject to the Company's Conditions of Sale. The extent of the Company's liabilities to any customer is clearly set out in those Conditions; a copy of which is available on request.

Weights

All weights shown in this publication are for guidance only. They are calculated using nominal dimensions and scientifically recognised densities. Please note that in practice, the actual weight can vary significantly from the theoretical weight due to variations in manufacturing tolerances and compositions.

Copyright 2007: All Rights reserved: Aalco Metals Limited. No part of this publication may be reproduced, stored in a retrieval system or transmitted in any form or by any means, electronic, mechanical, recording or otherwise without the prior written consent of the proprietor.

Aalco is a registered trade mark of Aalco Metals Limited.

Issue No. 3 – 02/2011

Aalco is the UK's largest independent multi-metals stockholder. Customers from every sector of UK manufacturing and engineering industry, whether small local businesses or large multinational corporations, benefit from a cost-effective single source for all their metals requirements:

- An inventory that includes aluminium, stainless steel, copper, brass, bronze and nickel alloys in all semi-finished forms
- Comprehensive processing services providing items cut and/or finished to customer requirements
- Eighteen locations bringing local service to every corner of the UK
- Ongoing investment in technology and logistics to ensure on-time delivery

No order is too large or too small and Aalco offers a responsive and competitive service for supplying anything from single item orders to major JIT contracts, tailoring this service to the individual needs.

Whatever your requirement, in whatever quantity, your local Aalco service centre is ready and willing to satisfy your needs. For a quotation, for further information, more extensive technical information, advice on product selection or to place an order, please contact your local Aalco service centre or refer to the web site

www.aalco.co.uk

Service



The most comprehensive stock range; the highest investment in processing equipment; local service centres nationwide; helpful, friendly, knowledgeable staff and the industry's biggest fleet of delivery vehicles – it all adds up to unbeatable service.

Aalco has maintained market leadership over many years through an absolute dedication to customer service – a service level that is continuously monitored and improved through key performance indicators.

That's why, for reliable, on-time delivery of exactly what you want, when and where you need it, whether it's a small one-off item or a complex JIT contract, Aalco is the essential first choice.



People

Exceptional customer service starts with people. Aalco develops and retains high quality personnel using a variety of 'in house' courses which cover both skills training, product knowledge and teamwork.

Every Aalco Service Centre has a dedicated team of people working together to provide an unbeatable service to customers in their region.

Customers can expect to receive a quick and informed response to any enquiries for material or for information.

Quality



Aalco takes great care when selecting manufacturing sources for its products and every mill we use is measured against a series of predetermined quality control requirements.

All products supplied by Aalco conform to the relevant BS or international standards certification can be supplied on request.

Aalco service centres operate a quality manual designed to ISO9000/2005 requirements. Many vendor approvals and bespoke quality control systems are operated through individual Aalco service centres, including aerospace approved materials from Southampton and Hull.

AALCO: Delivering Customer Service, Investing in Capability

Standard Stock & "Specials"

In providing customers with a cost-effective single source for all their metals requirements, over 50% of Aalco sales are made up of non standard or customer-special items. Many such items are held in stock at the Service Centres for call-off by their local customers, whilst others are processed as required.

The Aalco multi-metal stock range comprises around 10,000 items of stainless steel, aluminium, copper, brass and bronze in all semi-finished forms. Full detail of the ranges is given on page 28 for stainless steel rolled products, page 33 for stainless steel bar, page 36 for stainless steel tubular products (tube, pipe, fittings & flanges), page 59 for rolled aluminium, page 62 for Aluminium Extrusions and page 70 for Copper-Based Alloys.

This combines with a comprehensive processing services offering items cut to customer's instructions as well as finishing and coating. In addition, Aalco regularly arranges sub-contract processing using a range of approved suppliers.

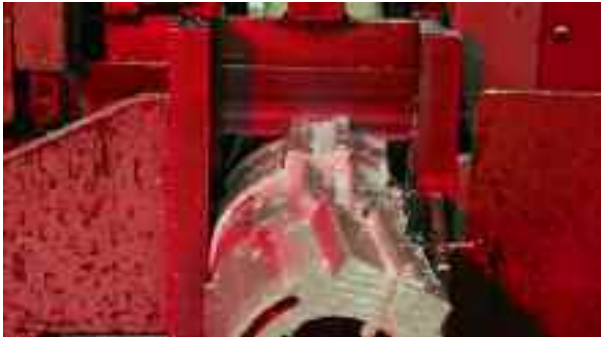

Aluminium Extrusions

As well as holding the UK's widest range of standard sections, Aalco has developed a particular expertise in the sourcing, stocking and processing of bespoke extrusions, bringing customers the benefit of Aalco's unrivalled purchasing power and sourcing expertise.

The standard stock range (detailed fully on page 60) covers round, flat & square bars in a choice of machinable alloys; tube, scaffold tube & box section; angle, tee & channel; a complete package of Road Transport sections plus a selection of shapes and sizes in various aerospace alloys.

The range of Road Transport sections includes bearers, runners, side rails, side guards, corner pillars, cant rails, tops hats, drop-sides, Zeds, mouldings, cappings and kick strips as well as a range of flooring options.

Processing Services

Processed material can save customers both time and money. Understanding this, Aalco has made a major investment in a wide range of modern processing equipment, particularly for cutting and finishing, at both its local and central service centres.

In addition, Aalco regularly arranges a wide array of processing services for customers on a sub-contract basis.



Logistics & Systems

Like all world-class distribution businesses, Aalco operates a hub and satellite system.

The satellites are 19 local Service Centres providing unrivalled service to customers in their local area.

The hub is The Metal Centre – a 270,000 square foot (25,000m²) facility located in the West Midlands, bringing together 6,000 tonnes of stock and 130 employees. This state-of-the-art facility has a capacity to handle over 150,000 tonnes per year thanks to the largest automated handling system in Europe – this comprises a 5,500 cassette Kasto system in two 14 metre high units and one 8 metre high unit.

Linking The Metal Centre to the Service Centres is a 25-vehicle carrier fleet that travels overnight to ensure that an item in stock anywhere across the country can be delivered to any Aalco customer the next day, using the local truck fleet of well over 100 vehicles.

Keeping the whole system operating at maximum efficiency are highly sophisticated Information Systems, designed in-house and undergoing constant development to support the evolution of the Aalco business and maximise customer service.

Product Information

Aalco provides a wealth of product information to ensure that its customers are fully informed, not just about the choice of materials and sizes available but also on a range of technical topics including product selection, specifications, properties, fabrication & joining, finishing, installation and maintenance.

Shown inside the front cover of this brochure is a selection of the other publications that are all available free of charge from your local Service Centre - Everything from simple data-sheets to a CD-ROM with over 400 pages of technical information on stainless steel tubular products. What's more, all of these publications are available on-line and for down-load at any time of the day or night, every day of the year at www.aalco.co.uk

Road Transport Products

The range includes:

- **Rolled Products** – sheet & patterned sheet, plate & treadplate, shate
- **Standard Extrusions** – angle, channel, tee, tube & box section, flat/square/round bar
- **Special Sections** – Bearers/Runners, Floor Planks, Side Raves & Guards, Corner Pillars, Cant Rails, Top Hats, Zeds, Mouldings, Kick Strips
- **Dropside Sections & Systems**
- **Slip-resistant flooring** – Phenolic mesh-faced Birch wood plywood
- **Cappings** – ABS & Aluminium/ABS
- **Patterned aluminium flooring sheet**
- **GRP Panels**



Energy, Offshore & Process Industries

Aalco has established a Contract Services Division to meet the specialist project requirements of the energy, offshore and process industries.



Based at Aalco's Service Centre in Hull, the Contract Services team includes a number of staff with extensive experience in the sector. With the backing of Aalco's huge UK stock as well as access to the Amari stock held by Aalco's associated companies in Europe, the new Division provides the process industries with an outstanding service for all project requirements. Customers range from nuclear fuel reprocessing facilities to onshore/offshore oil, gas and petrochemical plants where Aalco has ongoing exclusive supply contracts.

Export

The wide Aalco stock range is of great interest to customers throughout the world seeking ready availability of semi-finished metal alloys.

Because export customers have specialist requirements in areas such as packaging and documentation, all exports from Aalco are handled by a dedicated team located at our Southampton service centre, which sources a full range of materials and:

- Provides the specialist knowledge and procedures required to service export markets together with the appropriate quality approvals
- Arranges special testing, inspection, documentation and releases as required
- Is ideally located to provide international deliveries to customers world-wide.

Southampton is one of the UK's premier ports, with efficient and economic shipping routes for destinations across Europe and throughout the world. Equally, air-freight can be readily arranged for more urgent cargos.



Aalco stocks all of the commonly required forms of aluminium including sheet, coil, strip, plate, shate, treadplate, patterned sheet, tube, bar, sections and free-machining rod. In addition to a comprehensive range of standard shapes and sizes, Aalco Service Centres stock industry specific items and custom specials with numerous specialist products and alloys satisfying the needs of a broad range of industries. Aalco also provides a complete range of processing services including: bar; tube & pipe cutting; plate processing; coil processing and surface finishing.

Rolled Products

Plate	Finstock
Sheet	Treadplate
Shate	Patterned Sheet



Extrusions

Round, Flat, Hexagon & Square Bar
 Tube & Scaffold Tube
 Angle (Equal & Unequal)
 Channel
 Tee
 Square & Rectangular Box Section



Customer Special Extrusions

Aalco are the UK's largest purchaser of aluminium extrusions with an annual throughput approaching 20,000 tonnes, This gives Aalco unrivalled purchasing power and sourcing expertise, which is shared with its customers.

As a major customer of many leading extrusion mills, Aalco has access to the widest possible range of alloys, shapes and sizes. In-depth knowledge of each mill's particular specialities means Aalco customers are assured that their extrusions will be sourced from the most cost-effective source.

The stock range includes special alloys, shapes and sizes for many industries including building, marine, road transport, signage, leisure & sporting goods, engineering and aerospace.

A particular skill is the sourcing of bespoke extrusions, designed for individual customers – from single shapes to full suites. Many customers have found major benefits in sourcing from Aalco, rather than direct from the mill. These benefits include time saving, reduced costs, flexibility, the possibility to make regular changes in scheduled quantities, keeping abreast of technology changes, assistance with design and technical issues, all without sacrificing choice or quality. What's more, Aalco's purchasing power means all this can be achieved at a very competitive price.

The processing services provided for aluminium extrusions include:

- **Cut lengths** Single Pieces up to 16"/406mm diameter through to High Volume Repetition Cutting
- **Prefabrication** Drilling, Notching, Punching & Bending
- **Finishing** Anodising, Painting/Powder coating, Polishing, Chromating
- **Protection Coating or Sleaving**
- **Special Packaging including 'Kitting'.**

Other Product Ranges

Aalco, in addition to a wide range of standard products, also stock a huge selection of special items for particular industries and individual customers.

- **Building** Painted Sheet & Extrusions, Patterned Sheet & Treadplate
- **Road Transport** Sections, Castings, Plate & Shate, Patterned Sheet & Treadplate
- **Road Signs** Sheet, Blanks, Painted Sheet, Extrusions
- **Marine** Sections, Plate, Sheet, Treadplate, Transition Joints
- **Holloware** Deep drawing Quality Sheet, Circles & Rings
- **Process Plant** Pipe, Butt Weld Fittings & Flanges, Treadplate



Aluminium is the world's most abundant metal and is the third most common element, comprising 8% of the earth's crust. The versatility of aluminium makes it the most widely used metal after steel.

Although aluminium compounds have been used for thousands of years, aluminium metal was first produced around 170 years ago.

In the 120 years since the first industrial quantities of aluminium were produced, worldwide demand for aluminium has grown to around 29 million tons per year. About 22 million tonnes is new aluminium and 7 million tonnes is recycled aluminium scrap. The use of recycled aluminium is economically and environmentally compelling. It takes 14,000 kWh to produce 1 tonne of new aluminium. Conversely it takes only 5% of this to remelt and recycle one tonne of aluminium. There is no difference in quality between virgin and recycled aluminium alloys.

Pure aluminium is soft, ductile, corrosion-resistant and has a high electrical conductivity. It is widely used for foil and conductor cables, but alloying with other elements is necessary to provide the higher strengths needed for other applications. Aluminium is one of the lightest engineering metals, having a strength-to-weight ratio superior to steel.

By utilising various combinations of its advantageous properties such as strength, lightness, corrosion resistance, recyclability and formability, aluminium is being employed in an ever-increasing number of applications. This array of products ranges from structural materials through to thin packaging foils.

Properties

The major advantages of using aluminium are tied directly to its remarkable properties. Some of these properties are outlined in the following sections.

Strength-to-Weight Ratio

Aluminium has a density around one-third that of steel and is used advantageously in applications where high strength and low weight are required. This includes vehicles where low mass results in greater load capacity and reduced fuel consumption.

Corrosion Resistance

When the surface of aluminium metal is exposed to air, a protective oxide coating forms almost instantaneously. This oxide layer is corrosion-resistant and can be further enhanced with surface treatments, such as anodising.

Electrical and Thermal Conductivity

Aluminium is an excellent conductor of both heat and electricity. The great advantage of aluminium is that by weight, the conductivity of aluminium is around twice that of copper. This means that aluminium is now the most commonly used material in large power transmission lines.

The best alternatives to copper are aluminium alloys in the 1000 or 6000 series. These can be used for all electrical conduction applications, including domestic wiring.

Weight considerations mean that a large proportion of overhead, high-voltage power lines now use aluminium rather than copper. They do however, have a low strength and need to be reinforced with a galvanised or aluminium coated high-tensile steel wire in each strand.

Light and Heat Reflectivity

Aluminium is a good reflector of both visible light and heat, making it an ideal material for light fittings, thermal rescue blankets and architectural insulation.

Toxicity

Aluminium is not only non-toxic but also does not release any odours or taint products with which it is in contact. This makes aluminium suitable for use in packaging for sensitive products such as food or pharmaceuticals where aluminium foil is used.

Recyclability

The recyclability of aluminium is unparalleled. When recycled, there is no degradation in properties when recycled aluminium is compared to virgin aluminium. Furthermore, melting for the recycling of aluminium only requires around 5 percent of the input energy required to produce virgin aluminium metal.

Aluminium Production

Aluminium is extracted from the principal ore, bauxite. Significant bauxite deposits are found in Australia, the Caribbean, Africa, China and South America. Open cast techniques are commonly used to mine the bauxite.

The bauxite is purified using the Bayer process. This process involves dissolving aluminium trihydrate to leave alumina plus iron and titanium oxides. The iron and titanium oxides are by-products of the process and are often referred to as 'red mud'. Red mud must be disposed of with strong consideration given to environmental concerns.

Approximately four tonnes of bauxite are required to yield two tonnes of alumina, which yields one tonne of aluminium.

Smelting

The extraction of aluminium from alumina is achieved using an electrolytic process. A cell or pot is used that consists of a carbon lined steel shell. This shell forms a cathode. A consumable carbon anode is suspended in liquid cryolite (sodium aluminium fluoride) held within the pot at 950°C. Alumina is dissolved in the cryolite by passing low voltages at high amperages through the pot. This results in pure aluminium being deposited at the cathode.



Environmental Considerations

The aluminium industry is very conscious of the environmental impact of its activities. The mining and smelting of aluminium, plus the disposal of red mud can have a major environmental impact if not done properly.

The industry is proud of its efforts and achievements in rehabilitating open cast mine sites and the restoring flora and fauna to these sites. Such efforts have been rewarded with awards from the United Nations Environment Programme and red mud disposal areas are now being successfully revegetated.

Environmental requirements are met on pot line emissions through the use of specialist scrubbing system.

Recycling

The combination of two remarkable properties of aluminium makes the need to recycle the metal obvious. The first of these factors is that there is no difference between virgin and recycled aluminium. The second factor is that recycled aluminium only uses 5% of the energy required to produce virgin material.

Currently around 60-70% of aluminium metal is recycled at the end of its lifecycle but this percentage can still be vastly improved.

Applications

The properties of the various aluminium alloys has resulted in aluminium being used in industries as diverse as transport, food preparation, energy generation, packaging, architecture, and electrical transmission applications.

Depending upon the application, aluminium can be used to replace other materials like copper, steel, zinc, tin plate, stainless steel, titanium, wood, paper, concrete and composites.

Some examples of the areas where aluminium is used are given in the following sections.

Packaging

Corrosion resistance and protection against UV light combined with moisture and odour containment, plus the fact that aluminium is non-toxic and will not leach or taint the products has resulted in the widespread use of aluminium foils and sheet in food packaging and protection.

The most common use of aluminium for packaging has been in aluminium beverage cans. Aluminium cans now account for around 15% of the global consumption of aluminium.

Transport

After the very earliest days of manned flight, the excellent strength-to-weight ratio of aluminium have made it the prime material for the construction of aircraft.

The attractive properties of aluminium mean various alloys are now also used in passenger and freight rail cars, commercial vehicles, military vehicles, ships & boats, buses & coaches, bicycles and increasingly in motor cars.

The sustainable nature of aluminium with regards to corrosion resistance and recyclability has helped drive the recent increases in demand for aluminium vehicle components.

Marine Applications

Aluminium plate and extrusions are used extensively for the superstructures of ships. The use of these materials allows designers to increase the above waterline size of the vessel without creating stability problems. The weight advantage of aluminium has allowed marine architects to gain better performance from the available power by using aluminium in the hulls of hovercraft, fast multi-hulled catamarans and surface planing vessels.

Lower weight and longer lifecycles have seen aluminium become the established material for helidecks and helideck support structures on offshore oil and gas rigs. The same reasons have resulted in the widespread use of aluminium in oil rig stair towers and telescopic personnel bridges.

Building and Architecture

Aluminium use in buildings covers a wide range of applications. The applications include roofing, foil insulation, windows, cladding, doors, shop fronts, balustrading, architectural hardware and guttering.

Aluminium is also commonly used in the form of treadplate and industrial flooring.

Foils

Aluminium is produced in commercial foils as thin as 0.0065 mm (or 6.5 µm). Material thicker than 0.2mm is called sheet or strip.

Aluminium foil is impervious to light, gases, oils and fats, volatile compounds and water vapour. These properties combined with high formability, heat and cold resistance, non-toxicity, strength and reflectivity to heat and light mean aluminium foil is used in many applications.

These applications include:

- Pharmaceutical packaging
- Food protection and packaging
- Insulation
- Electrical shielding
- Laminates

Other Applications

The above applications account for approximately 85% of the aluminium consumed annually.

The remaining 15% is used in applications including:

- Ladders
- High pressure gas cylinders
- Sporting goods
- Machined components
- Road barriers and signs
- Furniture
- Lithographic printing plates

Alloy Designations

Aluminium is most commonly alloyed with copper, zinc, magnesium, silicon, manganese and lithium. Small additions of chromium, titanium, zirconium, lead, bismuth and nickel are also made and iron is invariably present in small quantities.

There are over 300 wrought alloys with 50 in common use. They are normally identified by a four figure system which originated in the USA and is now universally accepted. Table 1 describes the system for wrought alloys. Cast alloys have similar designations and use a five digit system.

Designations for wrought aluminium alloys

Alloying Element	Wrought
None (99%+ Aluminium)	1XXX
Copper	2XXX
Manganese	3XXX
Silicon	4XXX
Magnesium	5XXX
Magnesium + Silicon	6XXX
Zinc	7XXX
Lithium	8XXX

For unalloyed wrought aluminium alloys designated 1XXX, the last two digits represent the purity of the metal. They are the equivalent to the last two digits after the decimal point when aluminium purity is expressed to the nearest 0.01 percent. The second digit indicates modifications in impurity limits. If the second digit is zero, it indicates unalloyed aluminium having natural impurity limits and 1 through 9, indicate individual impurities or alloying elements.

For the 2XXX to 8XXX groups, the last two digits identify different aluminium alloys in the group. The second digit indicates alloy modifications. A second digit of zero indicates the original alloy and integers 1 to 9 indicate consecutive alloy modifications.

Physical Properties

Density

Aluminium has a density around one-third that of steel or copper making it one of the lightest commercially available metals. The resultant high strength to weight ratio makes it an important structural material, allowing increased payloads or fuel savings for transport industries in particular.

Strength

Pure aluminium doesn't have a high tensile strength. However, the addition of alloying elements like manganese, silicon, copper and magnesium can increase the strength properties of aluminium and produce an alloy with properties tailored to particular applications.

Aluminium is well suited to cold environments. It has the advantage over steel in that its tensile strength increases with decreasing temperature, while retaining its toughness. Steel, on the other hand, becomes brittle at low temperatures.

Corrosion Resistance

When exposed to air, a layer of aluminium oxide forms almost instantaneously on the surface of aluminium. This layer has excellent resistance to corrosion. It is fairly resistant to most acids but less resistant to alkalis.

Thermal Conductivity

The thermal conductivity of aluminium is about three times greater than that of steel. This makes aluminium an important material for both cooling and heating applications such as heat-exchangers. Combined with it being non-toxic, this property means aluminium is used extensively in cooking utensils and kitchenware.

Electrical Conductivity

Along with copper, aluminium has an electrical conductivity high enough for use as an electrical conductor. Although the conductivity of the commonly used conducting alloy (1350) is only around 62% of annealed copper, it is only one-third the weight and can therefore conduct twice as much electricity when compared with copper of the same weight.

Reflectivity

From UV to infra-red, aluminium is an excellent reflector of radiant energy. Visible light reflectivity of around 80% means it is widely used in light fixtures. The same properties of reflectivity makes aluminium ideal as an insulating material to protect against the sun's rays in summer, while insulating against heat loss in winter.

Typical properties for aluminium

Property	Value
Atomic Number	13
Atomic Weight (g/mol)	26.98
Valency	3
Crystal Structure	FCC
Melting Point (°C)	660.2
Boiling Point (°C)	2480
Mean Specific Heat (0-100°C) (cal/g.°C)	0.219
Thermal Conductivity (0-100°C) (cal/cms. °C)	0.57
Co-Efficient of Linear Expansion (0-100°C) (x10-6/°C)	23.5
Electrical Resistivity at 20°C (μ_.cm)	2.69
Density (g/cm ³)	2.6898
Modulus of Elasticity (GPa)	68.3
Poissons Ratio	0.34

Mechanical Properties

Aluminium can be severely deformed without failure. This allows aluminium to be formed by rolling, extruding, drawing, machining and other mechanical processes. It can also be cast to a high tolerance.

Alloying, cold working and heat-treating can all be utilised to tailor the properties of aluminium.

The tensile strength of pure aluminium is around 90 MPa but this can be increased to over 690 MPa for some heat-treatable alloys.

The EN standards differ from the old standard, BS 1470 - BS 1475 in the following areas:

- Chemical compositions – unchanged.
- Alloy numbering system – unchanged.

- Temper designations for heat treatable alloys now cover a wider range of special tempers. Up to four digits after the T have been introduced for non-standard applications (e.g. T6151).
- Temper designations for non heat treatable alloys – existing tempers are unchanged but tempers are now more comprehensively defined in terms of how they are created. Soft (O) temper is now H111 and an intermediate temper H112 has been introduced. For alloy 5251 tempers are now shown as H32/H34/H36/H38 (equivalent to H22/H24, etc). H19/H22 & H24 are now shown separately.
- Mechanical properties – remain similar to previous figures. 0.2% Proof Stress must now be quoted on test certificates.

Mechanical properties of selected aluminium alloys

Alloy	Temper	Proof Stress 0.2% (MPa)	Tensile Strength (MPa)	Shear Strength (MPa)	Elongation A5 (%)	Hardness Vickers (HV)
AA1050A	H12	85	100	60	12	30
	H14	105	115	70	10	36
	H16	120	130	80	7	-
	H18	140	150	85	6	44
	0	35	80	50	42	20
AA2011	T3	290	365	220	15	100
	T6	300	395	235	12	115
AA3103	H14	140	155	90	9	46
	0	45	105	70	29	29
AA4015	0	45	110-150	-	20	30-40
	H12	110	135-175	-	4	45-55
	H14	135	160-200	-	3	-
	H16	155	185-225	-	2	-
	H18	180	210-250	-	2	-
AA5083	H32	240	330	185	17	95
	0/H111	145	300	175	23	75
AA5251	H22	165	210	125	14	65
	H24	190	230	135	13	70
	H26	215	255	145	9	75
	0	80	180	115	26	46
AA5754	H22	185	245	150	15	75
	H24	215	270	160	14	80
	H26	245	290	170	10	85
	0	100	215	140	25	55
AA6063	0	50	100	70	27	85
	T4	90	160	11	21	50
	T6	210	245	150	14	80
AA6082	0	60	130	85	27	35
	T4	170	260	170	19	75
	T6	310	340	210	11	100
AA6262	T6	240	290	-	8	-
	T9	330	360	-	3	-
AA7075	0	105-145	225-275	150	9	65
	T6	435-505	510-570	350	5	160

Heat Treatment

A range of heat treatments can be applied to aluminium alloys:

- Homogenisation – the removal of segregation by heating after casting.
- Annealing – used after cold working to soften work-hardening alloys (1XXX, 3XXX and 5XXX).
- Precipitation or age hardening (alloys 2XXX, 6XXX and 7XXX).
- Solution heat treatment before ageing of precipitation hardening alloys.
- Stoving for the curing of coatings.

After heat treatment a suffix is added to the designation numbers.

- The suffix F means “as fabricated”.
- O means “annealed wrought products”.
- T means that it has been “heat treated”.
- W means the material has been solution heat treated.
- H refers to non heat treatable alloys that are “cold worked” or “strain hardened”.

The non-heat treatable alloys are those in the 3XXX, 4XXX and 5XXX groups.

EN Heat treatment designations

Term	Description
T1	Cooled from an elevated temperature shaping process and naturally aged.
T2	Cooled from an elevated temperature shaping process cold worked and naturally aged.
T3	Solution heat-treated cold worked and naturally aged to a substantially.
T4	Solution heat-treated and naturally aged to a substantially stable condition.
T5	Cooled from an elevated temperature shapin process and then artificially aged.
T6	Solution heat-treated and then artificially aged.
T7	Solution heat-treated and overaged/stabilised.

Work Hardening

The non-heat treatable alloys can have their properties adjusted by cold working. Cold rolling is a typical example.

These adjusted properties depend upon the degree of cold work and whether working is followed by any annealing or stabilising thermal treatment.

Nomenclature to describe these treatments uses a letter, O, F or H followed by one or more numbers. As outlined in Table 6, the first number refers to the worked condition and the second number the degree of tempering.

Non-Heat treatable alloy designations

Term	Description
H1X	Work hardened
H2X	Work hardened and partially annealed
H3X	Work hardened and stabilized by low temperature treatment
H4X	Work hardened and stoved
HX2	Quarter-hard – degree of working
HX4	Half-hard – degree of working
HX6	Three-quarter hard – degree of working
HX8	Full-hard – degree of working

Temper codes for plate

Code	Description
H112	Alloys that have some tempering from shaping but do not have special control over the amount of strain-hardening or thermal treatment. Some strength limits apply.
H321	Strain hardened to an amount less than required for a controlled H32 temper.
H323	A version of H32 that has been specially fabricated to provide acceptable resistance to stress corrosion cracking.
H343	A version of H34 that has been specially fabricated to provide acceptable resistance to stress corrosion cracking.
H115	Armour plate.
H116	Special corrosion-resistant temper.



Aluminium materials are characterised by their lightness, strength, corrosion resistance, high durability and formability, leading to a wide range of product forms and extensive use in engineering applications. However, despite its high durability and corrosion resistance, some simple steps should be employed when handling and cleaning aluminium to avoid staining and damage, as some alloys tend to be quite soft.

Receiving Material

In many cases aluminium components are supplied with a polished surface that is protected by a strippable plastic or paper coating. Upon receipt, the coating should be inspected for any damage that might have been transferred to the underlying aluminium.

Upon receipt, materials should also be inspected for signs of wetness to avoid the possibility of water staining. This should include looking for wet packaging or pallets.

Materials should also be moved indoors for storage into dry conditions. This should be done immediately on damp or rainy days.

Handling

To avoid damage to the surface of aluminium components, some care is needed in handling.

This includes:

- Avoid allowing aluminium to scrape against hard or sharp surfaces
- Two people should be used when stacking/unstacking or moving sheets to avoid dragging them over one another
- Do not drag or throw aluminium components
- In order to avoid distortion or damage, use soft slings when lifting heavy components
- Do not walk over sheets whilst moving them.

Storage

If being stored for extended periods, aluminium should be lightly oiled and stored vertically to ensure air circulation over all surfaces.

Aluminium should be stored indoors, in a clean, dry, dust and contaminant free environment and not be in contact with other materials.

Water staining

A common problem with aluminium is water staining. Water staining is generally a white powdery substance on the surface of the aluminium, but depending on the alloy or amount of oxidation it may have an iridescent appearance. It is caused by the entrapment of moisture between the surfaces of closely packed aluminium. High magnesium alloys produce the most water stain. The only detrimental effect of water staining is aesthetic, as it doesn't alter the mechanical properties of aluminium.

If material is delivered wet, it should be allowed to dry thoroughly before storage. This should be done by evaporation using dry air. Removal of the moisture will prevent stains occurring and halt the growth of any existing water stains.

The extent of existing stains can be determined by surface roughness. Light staining will be smooth and can be removed by brushing. For extensive staining (rough surface) dipping in an aqueous solution of 10% by volume sulphuric acid and 3% by weight chromic acid may be required.

Installation

Installation and delivery of aluminium components should always be delayed to the last possible moment to avoid accidental staining and/or damage.

Newly installed aluminium components most commonly require cleaning due to carelessness with nearby work procedures. This results in staining from such things as mortar, concrete and paints.

This can be avoided or minimized by protecting aluminium surfaces with a clear lacquer or light oil. If the aluminium is tainted with a wet product it should be removed before drying and washed thoroughly with water. If dry mortar, plaster or paint needs to be removed from aluminium by scraping, use a plastic or wooden scraper. Metal scrapers will damage the surface of the aluminium.

Maintenance

The best way to keep aluminium looking pristine is regular cleaning to remove any build up of dirt. If left for an extended period of time, grime can cause staining and, depending on the extent of staining, will require a harsher cleaning system to remove the stain. In cleaning aluminium one should always start with the mildest method possible and only move to successively harsher treatments if absolutely necessary.

Cleaning Methods

The cleaning methods in ascending order of harshness are:

- Plain water
- Mild soap / detergent
- Solvents such as kerosene, turpentine or white spirit
- Non-etching chemical cleaner
- Wax-based polish
- Abrasive wax
- Abrasive cleaner

After cleaning, the aluminium should be washed thoroughly and dried to prevent streaking. Special care should be taken to remove any traces of cleaner from edges and joints. Always follow manufacturers' recommendations when using proprietary cleaning products.

Abrasive cleaners can alter the appearance of polished aluminium or aluminium with a 'grain' finish. If the aluminium has a grain, always clean with the grain.

Aluminium alloys are normally supplied as semi-finished products such as sheet, plate, coil, extrusions, tube or wire. All forms can then be readily fabricated into finished products using a wide range of processes.

Aalco provides a range of cutting and pre-fabrication services including coil slitting, cut-to-length and guillotining of sheet and plate, cut lengths of extrusion and tube, polishing, coating, drilling, slotting, bending and weld preparation of edges.

Cutting

Aluminium can be cut by many different methods, depending on the shape and form of the aluminium. Aluminium plate is cut with various types of saw and also laser, plasma or water jet to produce finished sizes that can have intricate shapes. The advantage of water jet cutting is the lack of heat and therefore no alteration of the properties of the aluminium.

Aluminium extrusion and tube is routinely cut with carbon tipped circular saw blades. Blade cutting can be improved by using a stick wax on the blade to improve lubrication. Other cutting methods include band-sawing and guillotining.

Aalco routinely supply plate cut to size including circles, rings and irregular shapes.

Grades, Tempers and Formability

When producing an aluminium product, the grade selection must be made with consideration given to not only the durability of the alloy when in service, but also if the product can be readily fabricated from that material.

Although the formability of an aluminium alloy relates directly to the type of alloy, the temper of each alloy can change properties in such a way that the same grade may be perfect for a given application in one temper, but completely unsuited in another.

General fabrication properties of the various alloy series are given in Table 1.

Table 1. Fabrication properties of aluminium alloys

Alloy	Properties
1XXX	Excellent formability, weldability and corrosion resistance. Low strength.
2XXX	Excellent machinability and high strength. Poor formability, weldability and corrosion resistance.
3XXX	Formable, corrosion resistant and weldable. Moderate strength.
4XXX	Formable, weldable, corrosion resistant.
5XXX	Formable, weldable, excellent corrosion resistance.
6XXX	Formable, corrosion resistant, medium-to-high-strength.
7XXX	Machinable, poor corrosion resistance and weldability. High strength.
8XXX	Excellent formability.

For non-heat treatable alloys additional strength is imparted to the alloy by work hardening. The alloy can then be softened to the desired properties by heating in an annealing stage.

For heat treatable alloys, strength is imparted by heating followed by quenching and ageing. Quenching is a rapid cooling process using air or water.

Deep Drawing

Deep drawing is a common fabrication method for aluminium and is the process used to make one of the world's most common aluminium products; aluminium drinks cans. Deep drawing uses extremely high forces to push a sheet or blank of a relatively soft alloy into a female draw cavity. Several stages are used in the process and appropriate lubrication is required.

Deep drawing is a valued fabrication method as it produces a seamless product. Due to the forming method, products manufactured by deep drawing essentially have a cup like shape. Aluminium alloys used for deep drawing include 3003, 5005, and 5052.

Bending

Aluminium can be bent using any one of a number of different techniques. The choice of the most appropriate is dictated by factors such as the form and temper of the alloy in question.

The most common form of aluminium that is bent is tubing. When tube is to be bent, drawn tube should be specified as it bends more consistently and to tighter tolerances than extruded tube.

Four main methods are used for bending aluminium:

- Three roll bending
- Three point bending
- Wrap and mandrel bending
- Stretch forming

Three Roll Bending

Three roll benders use a central roller that is moveable and is gradually depressed on the work piece until the desired radius is achieved.

Three Point Bending

Similar to three roll bending, the three point bender can apply a load via an impact or gradually. Both three roll and three point bending are used on strong sections.

Wrap and Mandrel Bending

Wrap and mandrel benders use formers and support tools to bend the aluminium to tight radii while minimising buckling. In wrap bending the former moves around the section. Mandrel bending differs in that the section moves around the former.

Stretch Forming

Stretch formers work with the section in tension being wrapped around a former. With the section in tension, compression failure is minimised.



Bend Radii

To avoid cracking when bending aluminium, the bend radius must be considered.

Minimum allowable bend radii are functions of the alloy, temper, cross sectional dimensions, mandrel use and the required surface finish. It is therefore not possible to give strict rules to the bend radii for all instances. Published bend radii tables should be consulted before bending and practical trials done before bending the work-piece.

Joining

The most common way of joining aluminium is welding. Most alloys of aluminium are able to be easily welded once a couple of factors are taken into consideration.

The corrosion resistance of aluminium is due to a tough oxide layer on the surface. This oxide layer has a higher melting point than aluminium and must be removed before welding. It is removed using chemical, mechanical or electrical means and must be prevented from reforming before welding can be completed.

Due to the high thermal conductivity of aluminium, heat needs to be applied at a rate four times that needed for steel. It has a linear expansion coefficient twice that for steel, which must be considered when welding material that has been restrained.

Aluminium has a relatively low melting point and unlike steel, it does not change colour as its melting point is approached.

Consequently, care must be taken not to overheat and/or melt aluminium during joining processes.

Welding tends to reduce the mechanical properties of aluminium in the heat affected zone. This area extends around 25mm from the weld.

Fusion Welding

For economic and quality reasons, MIG and TIG welding are the recommended methods for welding aluminium.

TIG and MIG Welding

TIG welding is suited to joining of lighter gauge materials with section thicknesses from about 0.8 to 12.5mm. It is also suited to the joining of pipes, ducting and intricate welds. Joints can be butts, lap welds, edge welds and fillets.

MIG welding allows for a high current density with deep penetration and welding speeds higher than for TIG. This means less total heat input and less chance of distortion. The process of TIG and MIG welding automatically removes the oxide layer electronically.

During the positive cycle of AC current, aluminium oxide particles are stripped from the weld pool allowing the fusion of oxide free metal in the next cycle.

Some pre-cleaning of the joint for welding is still required to ensure the weld is completely free of oxide.

Filler Alloys

Filler wires for MIG and TIG welding are restricted to pure aluminium, Al-Mg and Al-Si alloys.

Resistance Welding

For aluminium alloys, spot, seam, wire and flash welding are the most common types of resistance welding.

They all result in excellent joints, particularly with high-strength heat-treatable alloys. Resistance welding can be more economical than fusion welding but is not suited to all applications.

Friction Welding

It is not uncommon for a brittle zone to be created when aluminium is fusion welded to dissimilar metals. Friction welding can be used to overcome this problem. Processes such as friction stir welding have been found to be suited to the joining of aluminium alloys.

Brazing

Aluminium can be brazed by torch, dip or furnace processes as long as close temperature control is maintained.

Welding to Dissimilar Metals

Large differences in properties such as melting point, thermal conductivity and thermal expansion mean welding aluminium to dissimilar metals such as steel is extremely difficult and often impossible in extreme environments such as ship repair and offshore oil rigs.

In these instances explosion bonded transition joints are used. Structural Transition Joints (STJ) are bimetallic strips of material with a cross section that has an appropriate aluminium alloy on one side and a dissimilar material like steel on the other. The STJ is used to form a filler bridge between the dissimilar metals with each metal welded directly to the corresponding metal on the STJ.



Soldering

The oxide coating on aluminium and its high thermal conductivity makes soldering difficult. The larger the part being soldered, the more evident this becomes. A small part can be held at soldering temperature but a large part can become distorted as one section might be hot while another remains cold.

Fluxes used to remove the oxide layer can be corrosive and must be removed after soldering. To solder without flux the surface needs to be covered in molten flux and the surface below the liquid flux abraded before the two surfaces are joined.



Adhesive Bonding

As welding tends to reduce properties in the heat affected zone, aluminium parts are being increasingly joined with adhesives. Adhesives are now used for joining aluminium in structural applications such as aircraft flooring, vehicle body panels and even attaching street light poles to their bases.

The adhesive bonding of aluminium has grown in importance since the 1930's when it was observed that hot curing wood adhesives also worked extremely well on the surfaces of some metals. New technologies in the area of synthetic adhesives promise to further increase the importance of adhesive bonding for aluminium.

When adhesive bonding is used with aluminium, it is generally found that no bonding occurs between the adhesive and the aluminium metal. Rather the adhesive bonds to the aluminium oxide layer. Acid etching can be used as a surface preparation to create a bond directly to the aluminium. Surface preparation is dependant upon the type of adhesive being used and should be done in accordance with manufacturers recommendations.

It is also not adequate to simply use adhesive on a joint that would otherwise be welded or mechanically fastened. Joint design for adhesive bonding should

allow for maximum surface contact between the adhesive and the aluminium. The joint design should also consider the loading forces that the joint will endure. Adhesive bonding performs best when the forces are predominantly pure shear, tension or compression. The use of lap joints is common as they have a large joint surface area, load predominantly in tension and avoid cleaving or peeling forces.

Mechanical Joints

From small aluminium boats to aircraft, riveting is still used to make joints. Riveting, screwing and bolting can produce high strength joints without distortion or strength loss and requires less skill than for other joining methods.

Aluminium alloys used for rivets include 2017A, 2024, 5056, 5052, 5754, 6061, 6082 and 7075.

Machining

Although readily machinable, aluminium has a high coefficient of friction and high thermal coefficient of expansion. This means a special approach is required, including the use of polished tools with different tool geometry and good lubrication to avoid thermal stress.

Aluminium alloy 2011 is referred to as a free machining alloy (FMA) due to its excellent machining properties. 2011 has poor corrosion resistance and which leads to 6262 T9 being used when greater corrosion resistance is required.

Both 2011 and 6262 are commonly supplied in bar form. When machining of plate aluminium is required, the grade selected is 6082. Alloy 6082 machines very well and produces tight coils of swarf when chip breakers are used.

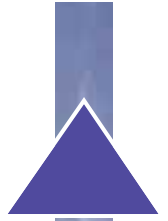

Filing and Grinding

Normal files and grinding wheels become clogged with aluminium filings. When rough filing aluminium the file should have deeply cut curved teeth with only around 4 teeth per centimetre. A long angle lathe file with 6 to 8 teeth per centimetre can be used for finer work and should be cleaned with a wire brush.

Chalk can be rubbed into the file to reduce clogging and immersion in a 20% caustic soda solution will dissolve the aluminium and clean the teeth.

For grinding, specialist wheels can be used. For coarse grinding use felt, leather or rubber covered discs with 60 to 120 grit emery or corundum abrasive and a paraffin lubricant. For fine grinding use 160 to 320 grit emery abrasive and small amounts of lubricant.

Finishing

Aluminium can be finished using mechanical, chemical, anodising and organic processes. Aalco has extensive polishing facilities to provide a range of finishes to meet every application.

Mechanical Finishing

Mechanical finishing most commonly involves grinding and polishing.

Grinding utilises an abrasive wheel attached to a rotary grinder. The preferred method is low speed grinding with aluminium oxide to avoid surface overheating.

Polishing uses wheels or belts with abrasives bonded to them. A buffing step can be included to remove any emery marks. Buffing wheels are usually made of muslin discs sewn together.

Chemical Finishing

Chemical finishes react with the metal surface to alter its form. They include conversion coatings and etching.

Conversion coatings thicken the natural oxide coating and allow for better bonding with paints, lacquers and other coatings. Chemical conversion films are thinner and cheaper than those produced by anodising.

Etching uses a chemical to attack and roughen the metal surface. Etching media can be either acid or alkaline. Alkaline etchants are cheaper and easier to handle, therefore more common. The most widely used is a solution of caustic soda in water. As etching removes the protective oxide layer, another step is required to restore it.

As chemical finishing involves the removal of metal to create a pattern or polish, it does result in a minor overall reduction in metal thickness.

Anodising

Anodising is an electrolytic process that is used to increase the thickness of the surface oxide films on aluminium. The resultant films are hard, durable and inert and have better corrosion resistance and strength compared to finishes produced by chemical processes. The anodic films are normally between 5 and 25 microns thick depending on the end use, in particular how aggressive the end-use environment. Anodic films can also be used as a base for dyes of any colour.



Chromate Conversion Coatings

Chromate conversion coating or chromating, is a process that coats aluminium with an extremely thin chemical coating. This coating can be used to impart enhanced corrosion resistance, conductivity and bonding ability to the aluminium substrate.

Chromating uses an aqueous solution containing chromates and certain activator ions to dissolve some of the base metal. This metal enters the solution as metal ions where it combines with the chromate ions and reforms on the metal surface as an adherent coating.

The advantage of chromating over anodising includes it not being an electrical process. This means electrical contact does not need to be made with the part and coating can be done on a bulk scale. This makes chromating generally faster, easier and therefore cheaper.

Two categories of chromates are used for aluminium:

- Chrome phosphates are primarily used on architectural aluminium extrusions to provide a paint-bonding coat.
- Chrome oxides are used on almost every type of aluminium including sheet, coil, castings and stampings. They are used to increase corrosion resistance and to enhance paint bonding.









Organic Coatings

Organic coatings include paint systems such as alkyd, acrylic, vinyl and epoxy coatings.

Organic coatings are commonly employed on aluminium for siding, awnings and aluminium cans.

They are typically applied using continuous processes while the aluminium sheet is still in coil form. Such coatings can be applied to one or both sides and more than one coat can be applied per side.

The Core Product Ranges are:

<p>Plate Alloys 6082 & 5083 in thicknesses 4 to 25mm Also aerospace release material. Treadplate (see below)</p>	
<p>Sheet Thicknesses from 0.5 to 3mm in alloys 1050, 5251, 3103, 6082 & 4015.</p>	
<p>Plate & Sheet Cutting Aalco, together with sister companies and approved sub-contractors, provides a full range of cutting services including guillotine, plate sawing, water-jet and laser as well as coil processing.</p>	
<p>Coil, Strip & Blanks Using sister companies and approved sub-contractors Aalco provides full range of coil processing services.</p>	
<p>Treadplate, Patterned Sheet & Painted Sheet Wide choice including: 5-Bar, Aalco TripleGrip, Stucco, etc. Also White Painted Sheet.</p>	
<p>Shate Aalco holds the largest UK stock of aluminium shate, thicknesses 4 to 8mm in alloys 6082, 1050, 5251 & 5083.</p>	
<p>Finstock Aalco holds 150mm I/D coils in Alloy 8006 - Temper 0 (Soft) The material is stocked in both plain finish and with both sides coated in Gold Epoxy Phenolic. A range of widths are available in ten thicknesses 0.10mm to 0.30mm. Special widths and thicknesses are also available to customer requirements.</p>	
<p>Transition Joint (For welding aluminium to steel) Explosively Bonded Sandwich with 3 layers – Al Alloy 5083/Pure Al (1050A)/Steel. Width 25mm/Height 35mm/3.8 metre lengths. All stock Lloyds Register of Shipping Approved.</p>	

Full detail of all product ranges, alloys and sizes can be found in the Aalco Stocklist available **FREE** from your local Service Centres as well as on the website.



The old BS 1470 standard has been replaced by nine EN standards:

Standard	Scope
EN 485-1	Technical conditions for inspection and delivery
EN 485-2	Mechanical Properties
EN 485-3	Tolerances for HOT Rolled Material
EN 485-4	Tolerances for COLD Rolled material
EN 515	Temper Designations
EN 573-1	Numerical alloy designation system
EN 573-2	Chemical symbol designation system
EN 573-3	Chemical Compositions
EN 573-4	Product forms in different alloys

For those familiar with the old BS 1470 it is useful to highlight where the new EN standards differ:

- Chemical Compositions – No Change.
- Alloy Numbering System – No Change.
- Temper Designations for Heat Treatable Alloys – A new wider range of special tempers having up to four digits after the T have been introduced for non-standard applications (e.g. T6151).
- Temper Designations for Non Heat Treatable Alloys – No change to existing tempers but a more comprehensive definition of how tempers are achieved. Soft (O) temper is now classified H111 and an intermediate temper H112 is introduced. For alloy 5251 tempers are now shown as H32/H34/H36/H38 (equivalent to H22/H24, etc). H19/H22 & H24 are now shown separately.
- Mechanical Properties – Similar but not identical. Also, 0.2% Proof Stress must now be quoted on test certificates.
- Thickness Tolerances – Considerably tighter for alloys 1050A & 3103. To reflect manufacturing difficulty the tolerances for alloys 5251, 5083 & 6082 are now wider than this, although still a little tighter than in BS 1470.
- Length & Width Tolerances – These tend to be tighter and are now all on the plus side (i.e. minus zero).
- Flatness Tolerances – These are considerably tighter.

Chemical Composition

Please refer to the datasheet entitled **Aluminium Specifications**.

Mechanical Properties

Please refer to the datasheet entitled **Aluminium Specifications**.

Flatness Tolerances

Product	Thickness	Max Deviation over a 2500mm length	Max Deviation over a 1250mm width
Cold Rolled	0.5 to 3.0	10.0mm	5.0mm
	3.0 to 6.0	7.5mm	3.75m
Hot Rolled	6.0 to 200	5.0mm	2.5mm

Alloy Groups

Alloy Group	Main Alloying Element	Common Alloys	Previous Name
1000 Series	Pure	1050 / 1200	1B/1C
2000 Series	Copper	2014	H15
3000 Series	Manganese	3103	N3
4000 Series	Silicon	Alclad 4343/4015	N21
5000 Series	Magnesium	5251/5083	N4/N8
6000 Series	Magnesium Silicon	6063/6082	H9/H30
7000 Series	Zinc Magnesium Copper	7020/7075	H17
8000 Series	Others	8011	

Length Tolerances

Thickness (mm)	Hot Rolled EN 485-3	Cold Rolled EN 485-4
	Minus 0mm	Minus 0mm
	Plus:	Plus:
0.2 to 3.0	8.0mm	6.0mm
3.0 to 6.0	8.0mm	8.0mm
6.0 to 12.0	10.0mm	10.0mm
12.0 to 50.0	12.0mm	-
Over 50.0	14.0mm	-

Applies to lengths 2001mm to 3000mm

Width Tolerances

Thickness (mm)	Hot Rolled EN 485-3	Cold Rolled EN 485-4
	Minus 0mm	Minus 0mm
	Plus:	Plus:
0.2 to 3.0	-	3.0mm
3.1 to 6.0	7.0mm	4.0mm
6.1 to 12.0	7.0mm	5.0mm
12.1 to 50.0	8.0mm	-
51.0 to 200	8.0mm	-
201 to 400	12.0mm	

Applies to widths 1001mm to 2000mm for hot rolled and 501mm to 1250mm for cold rolled. For 1500mm wide cold rolled the tolerances are plus 4mm, 5mm & 5mm.

Thickness Tolerances – Hot Rolled

Thickness (mm)	Tolerance (+ or –) in mm for given width in mm	
	1250	1500
2.5 to 4.0	0.28	0.28
4.1 to 5.0	0.30	0.30
5.1 to 6.0	0.32	0.32
6.1 to 8.0	0.35	0.40
8.1 to 10.0	0.45	0.50
10.1 to 15.0	0.50	0.60
15.1 to 20	0.60	0.70
21 to 30	0.65	0.75
31 to 40	0.75	0.85
41 to 50	0.90	1.0
51 to 60	1.1	1.2
61 to 80	1.4	1.5
81 to 100	1.7	1.8
101 to 150	2.1	2.2
151 to 220	2.5	2.6
221 to 350	2.8	2.9
351 to 400	3.5	3.7

Thickness Tolerances – Cold Rolled

Note that for thickness tolerances of cold rolled material the alloys are split into two groups:

- Group I – 1000 series, 3000 series, 4006, 4007, 5005, 5050, 8011A
- Group II – 2000 series, 6000 series, 7000 series, 3004, 5040, 5049, 5251, 5052, 5154A, 5454, 5754, 5182, 5083, 5086

Thickness (mm)	Tolerance on thickness (+ or –) in mm					
	1000mm Wide		1250mm Wide		1500mm Wide	
	Group I	Group II	Group I	Group II	Group I	Group II
0.20 to 0.40	0.02	0.03	0.04	0.05	0.05	0.06
0.41 to 0.50	0.03	0.03	0.04	0.05	0.05	0.06
0.51 to 0.6	0.03	0.04	0.05	0.06	0.06	0.07
0.61 to 0.8	0.03	0.04	0.06	0.07	0.07	0.08
0.81 to 1.0	0.04	0.05	0.06	0.08	0.08	0.09
1.01 to 1,20	0.04	0.05	0.07	0.09	0.09	0.10
1.21 to 1.50	0.05	0.07	0.09	0.11	0.10	0.12
1.51 to 1.80	0.06	0.08	0.10	0.12	0.11	0.13
1.81 to 2.0	0.06	0.09	0.11	0.13	0.12	0.14
2.1 to 2.5	0.07	0.10	0.12	0.14	0.13	0.15
2.6 to 3.0	0.08	0.11	0.13	0.15	0.15	0.17
3.1 to 3.5	0.10	0.12	0.15	0.17	0.17	0.19
3.6 to 4.0	0.15		0.20		0.22	
4.1 to 5.0	0.18		0.22		0.24	
5.1 to 6.0	0.20		0.24		0.25	
6.1 to 8.0	0.24		0.30		0.31	
8.1 to 10.0	0.27		0.33		0.36	
10.1 to 12.0	0.32		0.38		0.40	
12.1 to 15.0	0.36		0.42		0.43	
15.1 to 20	0.38		0.44		0.46	
21 to 25	0.40		0.46		0.48	
26 to 30	0.45		0.50		0.53	
31 to 40	0.50		0.55		0.58	
41 to 50	0.55		0.60		0.63	

When measuring thickness a zone 10mm wide from the edges of the product shall be disregarded.

The Core Product Ranges are:

Round Bar

1/4" to 16" diameter in three machining alloys:

~ 6082T6 - Machines well and, with chip-breakers, produced swarf in short tight coils.

~ 2011T3/T6 – Often referred to as FMA (Free Machining Alloy) this is produced specially for use on high speed automatics lathes. Offers exceptional machinability and forms fine chips which are easily removed.

Used particularly for components with complex, detailed or extensive machining.

Can sometimes replace free machining brass without tool changes.

~ 6262T9 – May be used in place of 2011 in applications requiring higher corrosion resistance and better anodising response. Has excellent machinability and surface finishing characteristics.

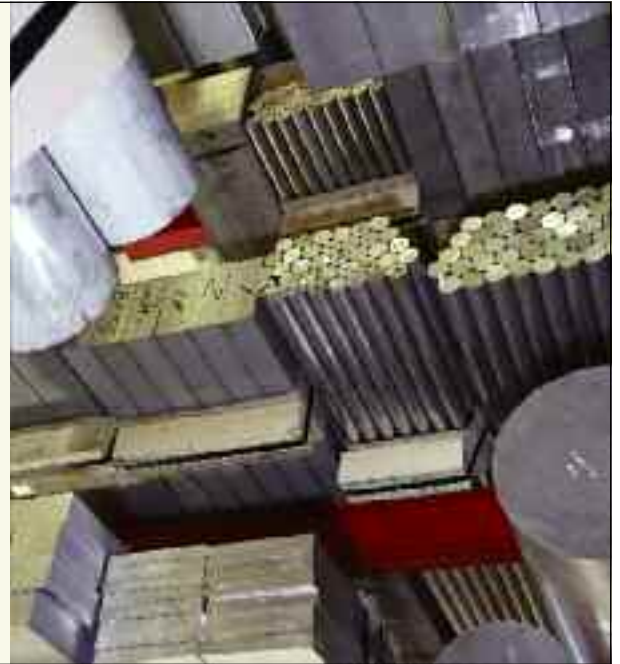

Flat Bar

3/8" x 1/4" to 6" x 1" in alloys 6082T6 and 6063A-T6

Square Bar

1/4" to 4" in alloy 6082T6

Tube & Box Section

In alloys 6082T6 & 6063T6:

~ Round from 3/8" O/D x 16swg to 6 1/2" O/D x 1/4" wall

~ Square 1/2" x 16swg to 4" x 1/4" wall

~ Rectangular from 1 1/2" x 3/4" x 16swg to 6" x 3" x 3/8" wall

Scaffold Tube

1 29/32" O/D x 7swg – drift tested to BS 1139

Tee

3/4" x 3/4" x 1/8" to 6" x 3" x 3/8" in alloys 6082T6 & 6063T6



Angle & Channel

In alloys 6082T6 & 6063T6:

- ~ Equal Angle from 1/2" x 1/2" x 1/16" to 6" x 6" x 1/2"
- ~ Unequal Angle from 1/4" x 1/2" x 1/16" to 6" x 3" x 3/8"
- ~ Channel (equal and unequal) from 3/4" x 1/2" to 8" x 3"



Road Transport Sections

A full range of bearers/runners, floor planks, side raves & guards, corner pillars, cant rails, top hats, zeds, mouldings, kick strips, curtain pole and associated products.



Bespoke Sections

Aalco is the UK's leading supplier of bespoke extrusions, providing customers across every sector of UK every industry with a huge range of sections cut and finished to their individual specifications. Sourcing expertise, purchasing power, in-depth knowledge of international supply sources plus relationships with all the major quality extruders in the world combine to ensure optimum solutions, on time and at competitive prices.



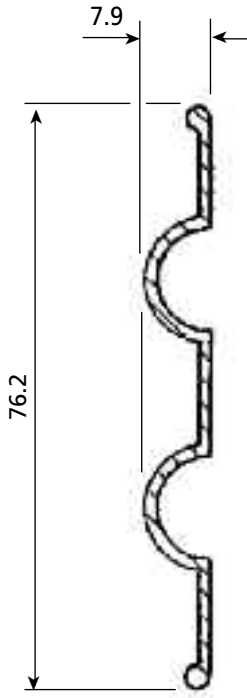

Wt. 0.432 kg/m

M101

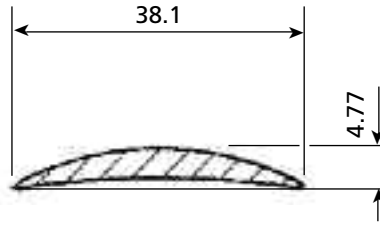

Wt. 0.267 kg/m

M102

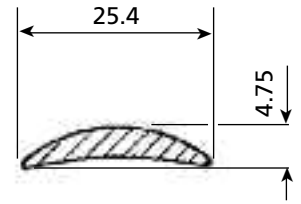

Wt. 0.196 kg/m

M103

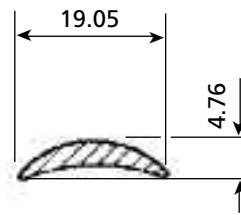

Wt. 0.144 kg/m

M104

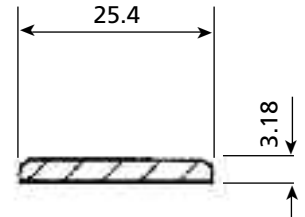

Wt. 0.206 kg/m

M105

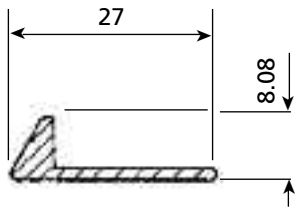

Wt. 0.140 kg/m

M106

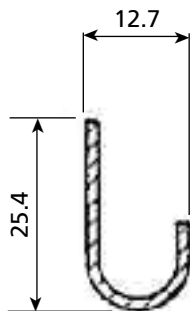

Wt. 0.189 kg/m

M107

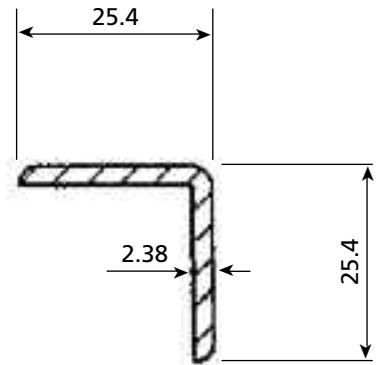

Wt. 0.30 kg/m

M109

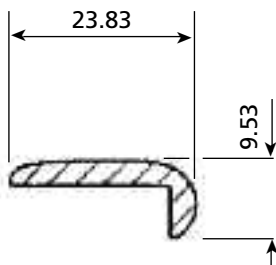

Wt. 0.217 kg/m

M116

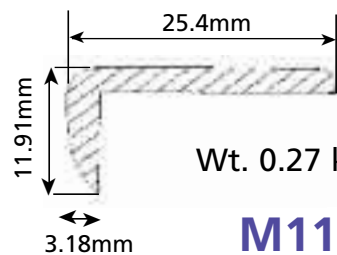

Wt. 0.27 kg/m

M117

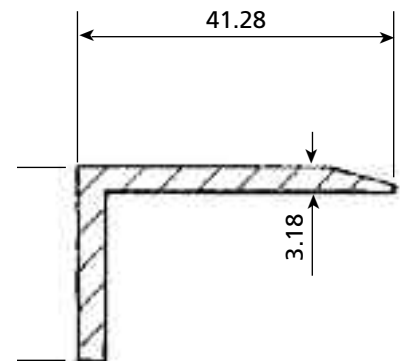

Wt. 0.519 kg/m

M118

These are just a selection of the many shapes available and may not be shown at actual size.

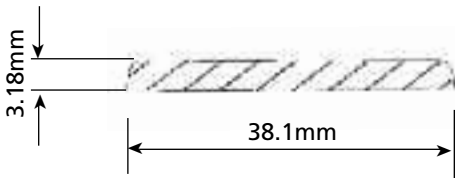

Wt. 0.33 kg/m

M150

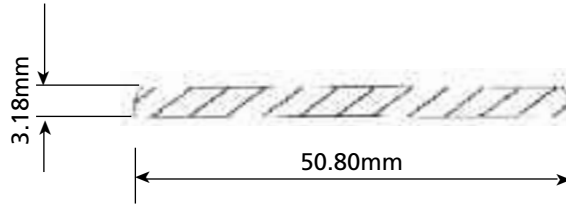

Wt. 0.44 kg/m

M200

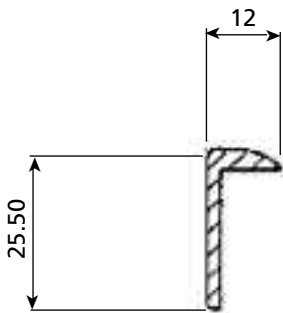

Wt. 0.23 kg/m

M306

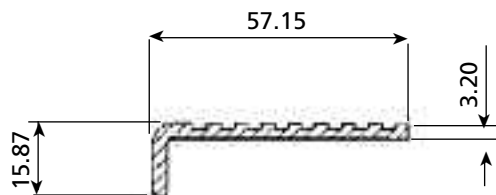

Wt. 0.50 kg/m

FH3

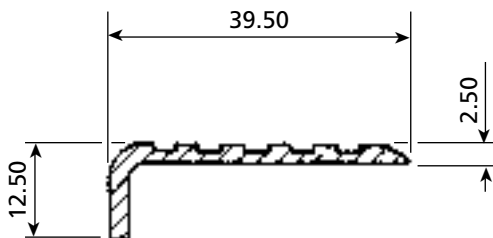

Wt. 0.272 kg/m

FH70

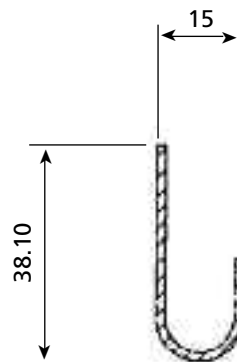

Wt. 0.28 kg/m

MJ52/GUT1504

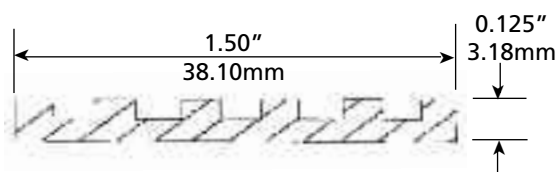

Wt. 0.25 kg/m

FS4

These are just a selection of the many shapes available and may not be shown at actual size.

The old BS 1474 – 1987 standard has been replaced by a number of EN standards of which the most important are:

Standard	Scope
EN 755	Extruded products
EN 755-1	Technical conditions for inspection and delivery
EN 755-2	Mechanical properties
EN 755-3	Tolerances for round bars
EN 755-4	Tolerances for square bars
EN 755-5	Tolerances for rectangular bars
EN 755-6	Tolerances for hexagon bars
EN 755-9	Tolerances on other profiles/shapes
EN 12020	Extruded precision profiles in alloys 6060 & 6063
EN 515	Temper Designations
EN 573-1	Numerical alloy designation system
EN 573-2	Chemical symbol designation system
EN 573-3	Chemical Compositions
EN 573-4	Product forms in different alloys

For those familiar with the old BS 1474 it is useful to highlight where the new EN standards differ:

- Chemical Compositions – No Change.
- Alloy Numbering System – No Change.
- Temper Designations for Heat Treatable Alloys – A new wider range of special tempers having up to four digits after the T have been introduced for non-standard applications (e.g. T6151).
- Temper Designations for Non Heat Treatable Alloys – No change to existing tempers but a more comprehensive definition of how tempers are achieved. Soft (O) temper is now classified H111 and an intermediate temper H112 is introduced. For alloy 5251 tempers are now shown as H32/H34/H36/H38 (equivalent to H22/H24, etc). H19/H22 & H24 are now shown separately.



Alloy Groups

Alloy Group	Main Alloying Element	Common Alloys	Previous Name
1000 Series	Pure	1050 / 1200	1B/1C
2000 Series	Copper	2014	H15
3000 Series	Manganese	3103	N3
4000 Series	Silicon	Alclad 4343/4015	N21
5000 Series	Magnesium	5251/5083	N4/N8
6000 Series	Magnesium Silicon	6063/6082	H9/H30
7000 Series	Zinc Magnesium Copper	7020/7075	H17
8000 Series	Others	8011	

Note that for the purposes of tolerances the alloys are split into two groups:

- **Group I** – 1000 series, 3000 series, 5005, 6101, 6005, 6106, 6060, 6063, 6463
- **Group II** – 2000 series, 7000 series, 5051, 5251, 5052, 5154, 5454, 5754, 5083, 5086



Diameter Tolerances – Round Bars

Diameter (mm)	Tolerances in mm Plus or Minus	
	Group I	Group II
10 to 18	0.22	0.30
19 to 25	0.25	0.35
26 to 40	0.30	0.40
41 to 50	0.35	0.45
51 to 65	0.40	0.50
66 to 80	0.45	0.70
81 to 100	0.55	0.90
101 to 120	0.65	1.00
121 to 150	0.8	1.2
151 to 180	1.0	1.4
181 to 220	1.15	1.7
221 to 270	1.3	2.0
271 to 320	1.6	2.5

Dimensional Tolerances – Hexagon Bars

Width Across Flats (mm)	Tolerances in mm Plus or Minus	
	Group I	Group II
10 to 18	0.22	0.30
19 to 25	0.25	0.35
26 to 40	0.30	0.40
41 to 50	0.35	0.45
51 to 65	0.40	0.50
66 to 80	0.50	0.70
81 to 100	0.55	0.90
101 to 120	0.65	1.0
121 to 150	0.80	1.2
151 to 180	1.0	1.4
181 to 220	1.15	1.7

Dimensional Tolerances – Square Bars

Width across Flats (mm)	Tolerances in mm Plus or Minus	
	Group I	Group II
10 to 18	0.22	0.30
19 to 25	0.25	0.35
26 to 40	0.30	0.40
41 to 50	0.35	0.45
51 to 65	0.40	0.50
66 to 80	0.40	0.70
81 to 100	0.55	0.90
101 to 120	0.65	1.00
121 to 150	0.80	1.20
151 to 180	1.0	1.4
181 to 220	1.15	1.70

Max Corner Radii – Square Bars

Width Across Flats (mm)	Tolerances in mm Plus or Minus	
	Group I	Group II
10 to 25	1.0	1.5
26 to 50	1.5	2.0
51 to 80	2.0	3.0
81 to 120	2.5	3.0
121 to 180	2.5	4.0
181 to 220	3.5	5.0

Squareness Tolerances – Square Bars

Width Across Flats (mm)	Max Deviation From Square (mm)
10 to 100	0.01 x Width Across Flats
101 to 180	1.0
181 to 220	1.5



Width Tolerance – Rectangular Bars

Width Across Flats (mm)	Tolerances in mm Plus or Minus	
	Group I	Group II
10 to 18	0.25	0.35
19 to 30	0.30	0.40
31 to 50	0.40	0.50
51 to 80	0.60	0.70
81 to 120	0.80	1.0
121 to 180	1.0	1.4
181 to 240	1.4	1.8
241 to 350	1.8	2.2
351 to 450	2.2	2.8
451 to 600	3.0	3.5

Squareness Tolerances – Rectangular Bars

Width Across Flats (mm)	Max Deviation From Square (mm)
2 to 10	0.1
11 to 100	0.01 x Width Across Flats
101 to 180	1.0
181 to 240	1.5



Thickness Tolerances for Rectangular Bars – Group I

Width Across Flats (mm)	Thickness Tolerances in mm Plus or Minus for given thickness range in m m								
	2-6	6.1-10	10.1-18	19-30	31-50	51-80	81-120	121-180	181-240
10 to 18	0.20	0.25	0.25	-	-	-	-	-	-
19 to 30	0.20	0.25	0.30	0.3	-	-	-	-	-
31 to 50	0.25	0.25	0.30	0.35	0.4	-	-	-	-
51 to 80	0.25	0.30	0.35	0.40	0.5	0.6	-	-	-
81 to 120	0.30	0.35	0.40	0.45	0.6	0.7	0.8	-	-
121 to 180	0.40	0.45	0.50	0.55	0.6	0.7	0.9	1.0	-
181 to 240	-	0.55	0.60	0.65	0.7	0.8	1.0	1.2	1.4
241 to 350	-	0.65	0.70	0.75	0.8	0.9	1.1	1.3	1.5
351 to 450	-	-	0.80	0.85	0.9	1.0	1.2	1.4	1.6
451 to 600	-	-	-	-	0.9	1.0	1.4	-	-

Thickness Tolerances for Rectangular Bars – Group II

Width Across Flats (mm)	Thickness Tolerances in mm Plus or Minus for given thickness range in m m								
	2-6	6.1-10	10.1-18	19-30	31-50	51-80	81-120	121-180	181-240
10 to 18	0.25	0.30	0.35	-	-	-	-	-	-
19 to 30	0.25	0.30	0.40	0.4	-	-	-	-	-
31 to 50	0.30	0.30	0.40	0.5	0.5	-	-	-	-
51 to 80	0.30	0.35	0.45	0.6	0.7	0.7	-	-	-
81 to 120	0.35	0.40	0.50	0.6	0.7	0.8	1.0	-	-
121 to 180	0.45	0.50	0.55	0.7	0.8	1.0	1.1	1.4	-
181 to 240	-	0.60	0.65	0.7	0.9	1.1	1.3	1.6	1.8
241 to 350	-	0.70	0.75	0.8	0.9	1.2	1.4	1.7	1.9
351 to 450	-	-	0.90	1.0	1.1	1.4	1.8	2.1	2.3
451 to 600	-	-	-	-	1.2	1.4	1.8	-	-

Diameter Tolerances for Seamless & Porthole Round Tube

Diameter (mm) OD or ID	Max Deviation of Mean Diameter + or - mm	Max Deviation at Any Point mm		
		Not Annealed or Heat Treated	Heat-Treated	Annealed
8 to 18	0.25	0.4	0.6	1.5
19 to 30	0.30	0.5	0.7	1.8
31 to 50	0.35	0.6	0.9	2.2
51 to 80	0.40	0.7	1.1	2.6
81 to 120	0.60	0.9	1.4	3.6
121 to 200	0.90	1.4	2.0	5.0
201 to 350	1.4	1.9	3.0	7.6
351 to 450	1.9	2.8	4.0	10.0

Wall Thickness Tolerances for SEAMLESS Round Tube

Wall Thickness (mm)	Tolerance Measured at Any Point (Plus or Minus %)
0.5 to 2.0	10
2.1 to 3.0	9
Over 3.0	8

Tolerances on Width, Depth or Width Across Flats for Seamless & Porthole Tube

Width, Depth or Width Across Flats mm	Tolerances in mm Plus or Minus for given Circumscribing Circle Dimension in mm							
	Up to 100mm		101 to 200mm		201 to 300mm		301 to 350mm	
	Grp I	Grp II	Grp I	Grp II	Grp I	Grp II	Grp I	Grp II
Up to 10	0.25	0.4	0.3	0.5	0.35	0.55	0.4	0.6
11 to 25	0.30	0.5	0.4	0.7	0.5	0.8	0.6	0.9
26 to 50	0.50	0.8	0.6	0.9	0.8	1.0	0.9	1.2
51 to 100	0.70	1.0	0.9	1.2	1.1	1.3	1.3	1.6
101 to 150	-	-	1.1	1.5	1.3	1.7	1.5	1.8
151 to 200	-	-	1.3	1.9	1.5	2.2	1.8	2.4
201 to 300	-	-	-	-	1.7	2.5	2.1	2.8
301 to 350	-	-	-	-	-	-	2.8	3.5

Tolerances on Wall Thickness for SEAMLESS Tube – Other Than Round Tube

Wall Thickness (mm)	Tolerances in mm Plus or Minus for given Circumscribing Circle Dimension in mm					
	Up to 100mm		101 to 300mm		301 to 350mm	
	Grp I	Grp II	Grp I	Grp II	Grp I	Grp II
0.5 to 1.5	0.25	0.35	0.35	0.50	-	-
1.51 to 3.0	0.30	0.45	0.50	0.65	0.75	0.9
3.1 to 6.0	0.50	0.6	0.75	0.90	1.0	1.2
6.1 to 10	0.75	1.0	1.0	1.3	1.2	1.5
11 to 15	1.0	1.3	1.2	1.7	1.5	1.9
16 to 20	1.5	1.9	1.9	2.2	2.0	2.5
21 to 30	1.9	2.2	2.2	2.7	2.5	3.1
31 to 40	-	-	2.5	-	2.7	-

Wall Thickness Tolerances for PORTHOLE Round Tube

Wall Thickness (mm)	Tolerance Measured at Any Point (Plus or Minus %)
0.5 to 2.0	7
2.1 to 3.0	6
Over 3.0	5

Tolerances on Wall Thickness for PORTHOLE Tube – Other Than Round Tube

Wall Thickness (mm)	Tolerances in mm Plus or Minus for given Circumscribing Circle Dimension in mm					
	Up to 100mm		101 to 300mm		301 to 350mm	
	Grp I	Grp II	Grp I	Grp II	Grp I	Grp II
0.5 to 1.5	0.20	0.30	0.3	0.4	-	-
1.51 to 3.0	0.25	0.35	0.4	0.5	0.6	0.7
3.1 to 6.0	0.40	0.55	0.6	0.7	0.8	0.9
6.1 to 10	0.60	0.75	0.8	1.0	1.0	1.2
11 to 15	0.80	1.0	1.0	1.3	1.2	1.5
16 to 20	1.2	1.5	1.5	1.8	1.7	3.0
21 to 30	1.5	1.8	1.8	2.2	2.0	3.5
31 to 40	-	-	2.0	2.5	2.0	3.0

- In this table alloys covered in the columns headed II are: 5051, 5251, 5052, 6012, 6018, 6351, 6061, 6262, 6081, 6082, 7 Series
- Other alloys are covered in the columns headed I



Corrosion Susceptibility of Metals

Most susceptible to corrosive attack (less noble)

Magnesium and its alloys
 Zinc and its alloys
 Aluminium and its alloys
 Cadmium
 Mild steel
 Cast iron
 Stainless steel, 13% Cr, type 410 (active)
 Lead-tin solder, 50/50
 Stainless steel, 18/18 type 304 (active)
 Stainless steel, 18/18/3% Mo, type 316 (active)
 Lead
 Tin
BRASSES
 Gunmetals
 Aluminium Bronzes
 Copper
 Copper-nickel alloys
 Monel
 Titanium and its alloys
 Stainless steel, 18/8, type 304 (passive)
 Stainless steel, 18/8/3 Mo, type 316 (passive)
 Silver
 Gold
 Platinum

Least susceptible to corrosive attack (more noble)

Imperial Wire and Sheet Metal Gauge

No.	Imperial Standard (swg)	
	ins	mm
0	0.324	8.23
1	0.300	7.62
2	0.276	7.01
3	0.252	6.40
4	0.232	5.89
5	0.212	5.38
6	0.192	4.88
7	0.176	4.47
8	0.160	4.06
9	0.144	3.66

No.	Imperial Standard (swg)	
	ins	mm
10	0.128	3.25
11	0.116	2.95
12	0.104	2.64
13	0.092	2.34
14	0.080	2.03
15	0.072	1.83
16	0.064	1.63
17	0.056	1.42
18	0.048	1.22
19	0.040	1.02

No.	Imperial Standard (swg)	
	ins	mm
20	0.036	0.914
21	0.032	0.813
22	0.028	0.711
23	0.024	0.610
24	0.0220	0.559
25	0.0200	0.508
26	0.0180	0.457
27	0.0164	0.417
28	0.0148	0.376



Conversion Factors

Description	From Unit	To Units	Multiply by
Angstrom units to microns			0.001
Atmospheres (standard) to pounds per square inch	A	lbf/in ² (psi)	14.70
Atmospheres (standard) to Pascal	A	Pa	101325
Bar to kilograms force per square centimetre	bar	kgf/cm ²	1.0197
Bar to pounds force per square inch	bar	lbf/in ² (psi)	14.5038
Centigrade to Fahrenheit	°C	°F	multiply by 1.8 and add 32
Centimetres to feet	cm	ft	0.03280840
Centimetres to inches	cm	in	0.393701
Centimetres ³ to feet ³	cm ³	ft ³	0.0000353147
Centimetres ³ to inches ³	cm ³	in ³	0.06102376
Fahrenheit to Centigrade	°F	°C	subtract 32 and multiply 0.5555
Feet per second to miles per hour	ft/s	mph	0.681818
Feet to centimetres	ft	cm	30.48
Feet to metres	ft	m	0.3048
Feet to millimetres	ft	mm	304.8
Feet ³ to metres ³	ft ³	m ³	0.02831685
Feet ³ to gallons	ft ³	gal	6.2288
Foot pounds to kilogram metres	ftlb	kgm	0.1382
Gallons (UK) to litres	gal	l	4.546092
Gallons (US) to litres	gal	l	3.785412
Grams per centimetres ³ to pounds per inch ³ (density)	gm/cm ³	lb/in ³	0.0361275
Grams to ounces	gm	oz	0.035274
Grams to pounds	gm	lb	0.00220462
Inches to centimetres	in	cm	2.540
Inches to metres	in	m	0.0254
Inches to millimetres	in	mm	25.4
Inches ³ to centimetres ³	in ³	cm ³	16.38706
Inches ³ to litres	in ³	l	0.01639
Kilogram metres to foot pounds	kgm	ftlb	7.233
Kilograms force to bar	kgf	B	0.9807
Kilograms force to Newtons	kgf	N	9.806650
Kilograms per metre to pounds per foot (assuming constant cross sectional area)	kg/m	lb/ft	0.671970
Kilograms per square centimetre to pounds per square inch	kg/cm ²	lb/in ² (psi)	14.223
Kilograms per square metre to pounds per square foot	kg/cm ²	lb/ft ²	0.2048
Kilograms per square metre to Newtons per square metre	kg/m ²	N/m ²	9.806650
Kilograms per square millimetre to pounds per square inch	kg/mm ²	lb/in ² (psi)	1422.34
Kilograms per square millimetre to tons per square inch	kg/mm ²	ton/in ²	0.63497
Kilograms to pounds	kg	lb	2.205
Kilograms to tons (long)	kg	ton	0.0009842
Kilometres to miles	km	mile	0.62137
Litres of water at 62°F to pounds	l	lb	2.205
Litres to inches ³	l	in ³	61.03
Litres to gallons (UK)	l	gal	0.2199692
Litres to gallons (US)	l	gal	0.2641720
Metres to inches	m	in	39.37008
Metres to microns			1 million
Metres to miles	m	miles	0.000621371
Metres to feet	m	ft	3.28084
Metres to yards	m	yd	1.093613
Metre ³ to inch ³	m ³	in ³	61023.76
Metre ³ to feet ³	m ³	ft ³	35.31466

Description	From Unit	To Units	Multiply by
Metre ³ to gallon (UK)	m ³	gallon	219.9692
Metre ³ to gallon (US)	m ³	gallon	264.1720
Metre ³ to litre	m ³	l	1000.0
Metre ³ to yard ³	m ³	yd ³	1.307951
Metric tons (or tonnes, 1000kg) to long tons	tonne	ton	0.9842
Microns to Angstrom units			1000
Microns to metres			0.000001
Microns to millimetres			0.001
Microns to thousands of an inch			0.03937008
Miles per hour to feet per second	mph	ft/s	1.46666
Miles to kilometres	m	km	1.60934
Millimetres to feet	mm	ft	0.003280840
Millimetres to inches	mm	in	0.03937008
Millimetres to microns			1000
Millimetres to thousands of an inch			39.37008
Newtons per square metre (Pascal) to kilograms per square metre	N/m ² (Pa)	kg/m ²	0.1019716
Newtons per square millimetre to pounds per square inch	N/mm ²	lb/in ² (psi)	145.0377
Newtons per square millimetre to tons per square inch	N/mm ²	tons/in ²	0.06475
Newtons to kilograms force	N	kgf	0.1019716
Newtons to pound force	N	lbf	0.2248089
Ounces to grams	oz	gm	28.3495
Pints imperial litres	pt	l	0.5679
Pounds force to Newtons	lbf	N	4.448222
Pounds per inch ³ to grams per centimetre ³ density	lb.in ³	gm/cm ³	27.67990
Pounds per foot to kilograms per metre (assuming constant cross sectional area)	lb/ft	kg/m	1.4882
Pounds per squarefoot to kilograms per square metre	lb/ft ²	kg/m ²	4.882429
Pounds per square inch to atmospheres	lb/in ² (psi)	A	0.06803
Pounds per square inch to bars	lb/in ² (psi)	bar	0.06894757
Pounds per square inch to kilograms per square centimetre	lb/in ² (psi)	kg/cm ²	0.07030697
Pounds per square inch to kilograms per square millimetre	lb/in ² (psi)	kg/cm ²	0.0007030697
Pounds per square inch to Newtons per square millimetre	lb/in ² (psi)	N/mm ²	0.006894757
Pounds to grams	lb	gm	453.60
Pounds to kilograms	lb	kg	0.453593
Square centimetres to square inches	cm ²	in ²	0.1550003
Square feet to square metres	ft ²	m ²	0.09290304
Square inches to square centimetres	in ²	cm ²	6.4516
Square inches to square millimetres	in ²	mm ²	645.16
Square kilometres to square miles	km ²	miles ²	0.386103
Square metres to square feet	m ²	ft ²	10.763910
Square metres to square yards	m ²	yd ²	1.195990
Square miles to square kilometres	miles ²	km ²	2.590
Square millimetres to square inches	mm ²	in ²	0.001550003
Square yards to square metres	yd ²	m ²	0.8361274
Tons per square inch to kilograms per square millimetre	ton/in ²	kg/mm ²	1.575
Tons per square inch to Newtons per square millimetre	ton/in ²	N/mm ²	15.4443
Tons (long) to kilograms	ton	kg	1016.047
Tons (long) to metric tons (or tonne, 1000kg)	ton	tonne	1.016047
Yards to metres	yd	m	0.9144
Yards ³ to metres ³	yd ³	m ³	0.7645549

Formulae for Calculation

All weights shown in this publication are theoretical weights for guidance only. They are calculated using nominal dimensions and scientifically recognised densities. The formulae used are shown below together with the densities of the alloys. Please note that in practice, the actual weight can vary significantly from the theoretical weight due to variations in manufacturing tolerances and compositions.

Form	Dimensions in mm	Weight for Alloys of Density p Kg/dm ³	
Round	Diameter = d	$0.00078540 d^2 p$	Kg/m
Hexagon	Width across flats = f	$0.00086603 f^2 p$	Kg/m
Square	Side = a	$0.00100 a^2 p$	Kg/m
Flat	Width = w Thickness = t	$0.00100 wtp$	Kg/m
Angle/Tee	Leg lengths = L_1, L_2 Thickness = t	$0.00100 (L_1 + L_2)t p$	Kg/m
Channel	Leg lengths = L_1, L_2 Base = B Thickness = t	$0.00100 (B + L_1 + L_2 - 2t)t p$	Kg/m
Plate/Sheet	Thickness = t Length = L Width = w	tp $0.000001 Lwtp$	Kg/m Kg/Sheet
Strip	Width = w Thickness = t	$0.100 wtp$	Kg/100m
Pipe/Tube (Round)	Outside diameter = D Inside diameter = d Wall thickness = t	$0.0031416 (D-t)t p$, or $0.0031416 (d+t)t p$	Kg/m
Square/Rectangular Tube	Sides = a_1, a_2 Wall thickness = t	$0.001 (2a_1 + 2a_2 - 4t)t p$	Kg/m
Wire	Diameter = d	$0.78540 d^2 p$	Kg/Km

Comparative Properties

Metal	Density	Melting Temp °C	Thermal Conductivity	Electrical Resistivity	UTS	Proof Stress	Elongation %	Typical Young's Modulus GPa
Aluminium pure	2.7	660	201	2.65	105	85	4	68
Aluminium alloy	2.7	660	184	3.7	310	260	7	68 to 89
Brass CZ121	8.5	954	110	6.33	400	190	20	103 to 120
Copper C101	8.9	1083	385	1.67	360	280	15	128 to 131
Iron	7.8	1537	80	9.71	210	120	40	152 to 183
Lead	11.3	327	35	20.65	20	0	60	16 to 18
Nickel alloy (Nimonic 105)	7.9	1327	12	132.0	990	800	5	180 to 234
Stainless Steel (18CR/8Ni)	7.9	1527	150	70	570	215	30	205 to 215
Mild Steel	7.8	1427	63	12	690	350	20	196 to 211
Tin	7.3	232	65	12.8	25	20	60	44 to 53

Chemical Elements

Aluminium – **Al**
 Arsenic – **As**
 Boron – **B**
 Cadmium – **Cd**
 Carbon – **C**
 Chromium – **Cr**
 Cobalt – **Co**
 Columbium – **Cb***
 Copper – **Cu**
 Hydrogen – **H**

Iron – **Fe**
 Lead – **Pb**
 Lithium – **Li**
 Manganese – **Mn**
 Molybdenum – **Mo**
 Nickel – **Ni**
 Niobium – **Nb**
 Nitrogen – **N**
 Oxygen – **O**
 Phosphorus – **P**

Selenium – **Se**
 Silicon – **Si**
 Sulphur – **S**
 Tellurium – **Te**
 Tin – **Sn**
 Titanium – **Ti**
 Zinc – **Zn**
 Zirconium – **Zr**

* The American designation for Niobium

Densities

Material	Density Kg/dm ³
Aluminium	2.70
Stainless Steel	
– Ferritic/Martensitic	7.75
– Austenitic	7.92
Copper	8.90
Brass	8.47
Bronze	8.89
INCOLOY® Alloy 800	7.95
INCOLOY® Alloy 800H	7.95
INCOLOY® Alloy 825	8.14
INCOLOY® Alloy 903	8.14
INCOLOY® Alloy DS	7.92
INCONEL® Alloy 600	8.42

Material	Density Kg/dm ³
INCONEL® Alloy 601	8.06
INCONEL® Alloy 617	8.36
INCONEL® Alloy 625	8.44
INCONEL® Alloy 690	8.19
INCONEL® Alloy 718	8.19
INCONEL® Alloy X-750	8.25
MONEL Alloy 400	8.83
MONEL Alloy K-500	8.46
Nickel 200	8.89
Nickel 201	8.89
UNS 31803	7.80
17-4 PH	7.75

Comparative Densities

Material	Density Kg/dm ³
Stainless Steel	1.000
Stainless Steel – Ferritic and Martensitic	0.977
Mild and Carbon Steel	0.994
Low Alloy Steel	0.987
Aluminium	0.341
Copper	1.134
Brass	1.066
Aluminium Bronze	0.970
Titanium	0.571
Lead	1.440



INCOLOY and INCONEL are both registered trademarks of SMC

AALCO SERVICE CENTRES

ABERDEEN

Unit 9B, Peterseat Drive
Peterseat Park, Altens
Aberdeen AB12 3HT
Tel: 01224 854810
Fax: 01224 871982
e-mail: aberdeen@aalco.co.uk

AYLESBURY

Unit 1, Premus
Coldharbour Way, Aylesbury
Buckinghamshire HP19 8AP
Tel: 01296 461700
Fax: 01296 339923
e-mail: aylesbury@aalco.co.uk

BELFAST

The Belfast Metal Centre
20 McKinney Road
Newtownabbey
County Antrim BT36 4PE
Tel: 02890 838838
Fax: 02890 837837
e-mail: belfast@aalco.co.uk

BIRMINGHAM

Shelah Road
Halesowen
West Midlands B63 3PH
Tel: 0121 585 3600
Fax: 0121 585 6864
e-mail: birmingham@aalco.co.uk

CHEPSTOW

Avenue West
Newhouse Park Estate
Chepstow
Monmouthshire NP16 6UD
Tel: 01291 638 638
Fax: 01291 638 600
e-mail: chepstow@aalco.co.uk

DYFED

Units 3-4
Capel Hendre Industrial Estate
Ammanford
Carmarthenshire SA18 3SJ
Tel: 01269 842044
Fax: 01269 845276
e-mail: dyfed@aalco.co.uk

ESSEX

Unit 2 Carnival Park
Festival Way
Basildon
Essex, SS14 3WN
Tel: 01268 884200
Fax: 01268 884220
e-mail: essex@aalco.co.uk

GLASGOW

117 Clydesmill Place
Cambuslang Investment Park
Glasgow G32 8RF
Tel: 0141 646 3200
Fax: 0141 646 3260
e-mail: glasgow@aalco.co.uk

HULL

Saxon Way
Priory Park West
Hessle
Hull HU13 9PB
Tel: 01482 626262
Fax: 01482 626263
e-mail: hull@aalco.co.uk

LEEDS

Unit 1
Revie Road off Elland Road
Leeds LS11 8JG
Tel: 0113 276 3300
Fax: 0113 276 0382
e-mail: leeds@aalco.co.uk

LIVERPOOL

207 Great Howard Street
Liverpool L5 9ZH
Tel: 0151 207 3551
Fax: 0151 207 2657
e-mail: liverpool@aalco.co.uk

MANCHESTER

Express Trading Estate
Stone Hill Road
Farnworth
Bolton BL4 9NN
Tel: 01204 863456
Fax: 01204 863430
e-mail: manchester@aalco.co.uk

NEWCASTLE

First Avenue
Team Valley Trading Estate
Gateshead, Tyne & Wear
NE11 0NU
Tel: 0191 491 1133
Fax: 0191 491 1177
e-mail: newcastle@aalco.co.uk

NORWICH

Roundtree Way
Mousehold Lane
Norwich NR7 8SR
Tel: 01603 787878
Fax: 01603 789999
e-mail: norwich@aalco.co.uk

NOTTINGHAM

Harrimans Lane
Dunkirk
Nottingham NG7 2SD
Tel: 0115 988 2600
Fax: 0115 988 2636
e-mail: nottingham@aalco.co.uk

SOUTHAMPTON

Test Lane, Nursling
Southampton SO16 9TA
Tel: 02380 875200
Fax: 02380 875275
e-mail: southampton@aalco.co.uk

STOKE

Unit F, Forge Way
Brown Lees Industrial Est
Biddulph
Stoke-on-Trent ST8 7DN
Tel: 01782 375700
Fax: 01782 375701
e-mail: stoke@aalco.co.uk

SWANLEY

Unit 7
Pedham Place Industrial Estate
Wested Lane,
Swanley
Kent BR8 8TE
Tel: 01322 610900
Fax: 01322 610910
e-mail: swanley@aalco.co.uk

www.aalco.co.uk

aalco[®]