

The logo for Aalco, featuring the word "aalco" in a bold, red, lowercase sans-serif font with a registered trademark symbol (®) to the upper right.

Standard Stock Range

The background is a dark blue gradient with a large, stylized red diamond shape in the center. This diamond is composed of several overlapping layers, creating a 3D effect. Scattered around the diamond are smaller white and red diamonds and squares, some with white outlines. The overall design is modern and industrial.

The UK's largest independent
multi-metals stockholder

www.aalco.co.uk



Aalco is the UK's largest independent multi-metals stockholder, with an extensive inventory of aluminium, stainless steel, copper, brass and bronze in all semi-finished forms. Aalco's stock covers a wide range of grades/alloys, shapes and sizes - both industry standards and special or bespoke items for particular applications or individual customers.

Aalco provides customers with a cost-effective single source for all their metals requirements, together with a comprehensive processing service for bespoke sizes and special finishes. No order is too large or too small and Aalco offers a responsive and competitive service supplying anything from single item orders to major JIT contracts, tailoring this service to the individual needs of every customer from small local businesses to major multinational corporations.

With 18 service centres nationwide, Aalco delivers on-time to every corner of the UK. Every Aalco service centre holds stocks to meet the immediate needs of customers in their local area, backed up by bulk stocks held at a central warehouse.

Whatever your requirement, in whatever quantity, your local Aalco service centre is ready and willing to satisfy your needs.

If you don't see what you want within these pages, give us a call - our range is continually expanding!

www.aalco.co.uk

September 2017 - Issue 16



Disclaimer

The information contained herein is based on our present knowledge and experience and is given in good faith. However no liability will be accepted by the Company in respect of any action taken by any third party in reliance thereon.

As the products used herein may be used for a wide variety of purposes and as the Company has no control over their use, the Company specifically excludes all conditions and warranties expressed or implied by statute or otherwise as to dimensions, properties and/or their fitness for any particular purpose. Any advice given by the Company to any third party is given for that party's assistance only and without any liability on the part of the Company.

Any contract between the Company and a customer will be subject to the Company's Conditions of Sale. The extent of the Company's liabilities to any customer is clearly set out in these Conditions; a copy of which is available on request.

Weights

All weights shown in this publication are for guidance only. They are calculated using nominal dimensions and scientifically recognised densities. Please note that in practice, the actual weight can vary significantly from theoretical weight due to variations in manufacturing tolerances and compositions.

Aalco is a registered trade mark of Aalco Metals Ltd

©2017 Aalco Metals Ltd

Metals Main Index

Aluminium	04
Stainless Steel	15
Brass	32
Copper	34
Bronze	35

18 Service Centres bring flexible local service to every corner of the UK

20,000+ Stock Items at local Service Centres and bulk central stock

Cut to size available at every Service Centre



120 Delivery Vehicles cover **6 million** miles every year

420,000+ deliveries per annum

140,000+ live customers



Comprehensive technical information and data available on web site at www.aalco.co.uk



Metals Main Index

Aluminium	04
Stainless Steel	15
Brass	32
Copper	34
Bronze	35

Aluminium Products

Sheet.....	5
Shate.....	6
Plate.....	6
Treadplate	6
Aalcopanel	6
Stucco Sheet	6
Painted Sheet	6
Round Bar	7
Flat Bar.....	7
Square Bar.....	8
Channel.....	8
Equal Angle.....	9
Unequal Angle	9
Tee Section	9
Round Tube.....	10
Scaffold Tube	10
Box Section - Square	10
Box Section - Rectangular.....	10
Mouldings.....	11
Road Transport Products	12

Aluminium Sheet



Aluminium Sheet Alloy 1050A H14/H24

Size	KG/Sheet
2000mm X 1000mm X 0.5mm	2.74
2500mm X 1250mm X 0.5mm	4.28
2000mm X 1000mm X 0.6mm	3.28
2500mm X 1250mm X 0.6mm	5.13
2000mm X 1000mm X 0.7mm	3.83
2500mm X 1250mm X 0.7mm	5.99
2000mm X 1000mm X 0.8mm	4.38
2500mm X 1250mm X 0.8mm	6.84
2438mm X 1219mm X 0.9mm	7.32
2000mm X 1000mm X 1.0mm	5.47
3000mm X 1000mm X 1.0mm	8.13
2500mm X 1250mm X 1.0mm	8.55
3000mm X 1250mm X 1.0mm	10.26
2000mm X 1000mm X 1.2mm	6.57
3000mm X 1000mm X 1.2mm	9.76
2438mm X 1219mm X 1.2mm	9.76
2500mm X 1250mm X 1.2mm	10.26
3000mm X 1250mm X 1.2mm	12.32
3658mm X 1250mm X 1.2mm	15.00
3000mm X 1500mm X 1.2mm	14.78
3658mm X 1500mm X 1.2mm	18.00
2000mm X 1000mm X 1.5mm	8.21
2500mm X 1000mm X 1.5mm	10.26
3000mm X 1000mm X 1.5mm	12.32
3100mm X 1000mm X 1.5mm	12.73
2500mm X 1250mm X 1.5mm	12.83
3000mm X 1250mm X 1.5mm	15.40
3250mm X 1250mm X 1.5mm	16.68
3500mm X 1250mm X 1.5mm	17.96
3658mm X 1250mm X 1.5mm	18.70
3750mm X 1250mm X 1.5mm	19.25
4000mm X 1250mm X 1.5mm	20.53
2500mm X 1500mm X 1.5mm	15.40
3000mm X 1500mm X 1.5mm	18.48
3658mm X 1500mm X 1.5mm	22.50
4000mm X 1500mm X 1.5mm	24.63
2438mm x 1219mm x 1.9mm	15.46
2500mm x 1250mm x 1.9mm	16.25
3100mm x 1250mm x 1.9mm	20.15
3000mm x 1500mm x 1.9mm	23.40
4000mm x 2000mm x 1.9mm	41.20
2000mm X 1000mm X 2.0mm	10.95
2500mm X 1000mm X 2.0mm	13.69
3000mm X 1000mm X 2.0mm	16.42
4000mm X 1000mm X 2.0mm	21.90
2500mm X 1250mm X 2.0mm	17.11
3000mm X 1250mm X 2.0mm	20.53
3100mm X 1250mm X 2.0mm	21.21
3250mm X 1250mm X 2.0mm	22.24
3500mm X 1250mm X 2.0mm	23.95
3658mm X 1250mm X 2.0mm	25.00
3750mm X 1250mm X 2.0mm	25.66
4000mm X 1250mm X 2.0mm	27.37
3000mm X 1400mm X 2.0mm	22.99
4000mm X 1400mm X 2.0mm	30.66
2500mm X 1500mm X 2.0mm	20.53
3000mm X 1500mm X 2.0mm	24.63
3100mm X 1500mm X 2.0mm	25.46
3250mm X 1500mm X 2.0mm	26.69
3500mm X 1500mm X 2.0mm	28.74
3658mm X 1500mm X 2.0mm	30.00
3750mm X 1500mm X 2.0mm	30.79
4000mm X 1500mm X 2.0mm	32.85
4000mm X 2000mm X 2.0mm	43.79
2438mm x 1219mm x 2.48mm	20.17

continued...

Sheet



Aluminium Sheet Alloy 1050A H14/H24

Size	KG/Sheet
2000mm X 1000mm X 2.5mm	13.69
3000mm X 1000mm X 2.5mm	20.33
2500mm X 1250mm X 2.5mm	21.38
3000mm X 1500mm X 2.5mm	30.79
2438mm x 1219mm x 2.79mm	22.70
2438mm x 1219mm x 2.9mm	23.59
2500mm x 1250mm x 2.9mm	24.80
3100mm x 1250mm x 2.9mm	30.76
3000mm x 1500mm x 2.9mm	35.72
4000mm x 2000mm x 2.9mm	63.50
2000mm X 1000mm X 3.0mm	16.42
2500mm X 1000mm X 3.0mm	20.53
3000mm X 1000mm X 3.0mm	24.63
2500mm X 1250mm X 3.0mm	25.66
3000mm X 1250mm X 3.0mm	30.79
3100mm X 1250mm X 3.0mm	31.82
3250mm X 1250mm X 3.0mm	33.36
3500mm X 1250mm X 3.0mm	35.92
3658mm X 1250mm X 3.0mm	37.50
3750mm X 1250mm X 3.0mm	38.49
4000mm X 1250mm X 3.0mm	41.06
3000mm X 1400mm X 3.0mm	34.49
4000mm X 1400mm X 3.0mm	45.98
2500mm X 1500mm X 3.0mm	30.79
3250mm X 1500mm X 3.0mm	40.03
3000mm X 1500mm X 3.0mm	36.95
3100mm X 1500mm X 3.0mm	38.18
3500mm X 1500mm X 3.0mm	43.11
3658mm X 1500mm X 3.0mm	44.90
3750mm X 1500mm X 3.0mm	46.19
4000mm X 2000mm X 3.0mm	65.69

Aluminium Sheet Alloy 5251 H22

Size	KG/Sheet
2000mm X 1000mm X 1.0mm	5.43
2500mm X 1250mm X 1.0mm	8.49
2000mm X 1000mm X 1.2mm	6.52
2500mm X 1250mm X 1.2mm	10.19
2000mm X 1000mm X 1.5mm	8.15
2500mm X 1250mm X 1.5mm	12.74
3000mm X 1500mm X 1.5mm	18.34
2000mm X 1000mm X 2.0mm	10.87
2500mm X 1250mm X 2.0mm	16.98
3000mm X 1500mm X 2.0mm	24.45
2000mm X 1000mm X 2.5mm	13.58
2500mm X 1250mm X 2.5mm	21.23
2000mm X 1000mm X 3.0mm	16.30
2500mm X 1250mm X 3.0mm	25.47
3000mm X 1500mm X 3.0mm	36.68

Aluminium Sheet Alloy 3103 H14

Size	KG/Sheet
2500mm X 1250mm X 1.5mm	12.92
2500mm X 1250mm X 2.0mm	17.23
2500mm X 1250mm X 3.0mm	25.85
3000mm X 1250mm X 3.0mm	31.02

Aluminium Sheet Alloy 5083 H111

Size	KG/Sheet
2500mm X 1250mm X 1.5mm	12.64
2500mm X 1250mm X 2.0mm	16.85
2000mm X 1000mm X 3.0mm	16.30
2500mm X 1250mm X 3.0mm	25.28
3000mm X 1500mm X 3.0mm	36.60

Sheet



Aluminium Architectural Sheet Alloy 1050A H14/H24 PVC Coated one side

Size	KG/Sheet
2500mm X 1000mm X 2.0mm	13.70
2500mm X 1600mm X 2.0mm	21.90
2500mm X 1750mm X 2.0mm	23.95
3000mm X 1400mm X 2.0mm	23.0
3000mm X 1600mm X 2.0mm	26.28
3000mm X 1750mm X 2.0mm	28.74
3000mm X 2000mm X 2.0mm	32.85
3100mm X 1250mm X 2.0mm	21.20
3250mm X 1250mm X 2.0mm	22.30
3500mm X 1250mm X 2.0mm	24.00
3658mm X 1250mm X 2.0mm	25.00
3750mm X 1250mm X 2.0mm	25.70
4000mm X 1400mm X 2.0mm	30.70
4000mm X 1600mm X 2.0mm	35.03
4000mm X 1750mm X 2.0mm	38.32
2438mm X 1219mm X 2.48mm	20.10
2438mm X 1219mm X 2.9mm	23.50
2500mm X 1250mm X 2.9mm	24.70
3100mm X 1250mm X 2.9mm	30.70
3000mm X 1500mm X 2.9mm	36.90
4000mm X 2000mm X 2.9mm	63.30
2500mm X 1000mm X 3.0mm	20.60
2500mm X 1500mm X 3.0mm	30.80
2500mm X 1600mm X 3.0mm	32.90
2500mm X 1750mm X 3.0mm	35.90
3000mm X 1400mm X 3.0mm	34.50
3000mm X 1600mm X 3.0mm	39.40
3000mm X 1750mm X 3.0mm	43.10
3000mm X 2000mm X 3.0mm	49.30
3100mm X 1250mm X 3.0mm	31.90
3100mm X 1500mm X 3.0mm	38.20
3250mm X 1250mm X 3.0mm	33.40
3250mm X 1500mm X 3.0mm	39.50
3500mm X 1250mm X 3.0mm	36.00
3500mm X 1500mm X 3.0mm	43.20
3658mm X 1250mm X 3.0mm	37.40
3658mm X 1500mm X 3.0mm	44.90
3750mm X 1250mm X 3.0mm	38.50
3750mm X 1500mm X 3.0mm	46.20
4000mm X 1400mm X 3.0mm	46.00
4000mm X 1600mm X 3.0mm	52.60
4000mm X 1750mm X 3.0mm	57.50

Aluminium Sheet Alloy 6082 T6

Size	KG/Sheet
2500mm X 1250mm X 2.0mm	17.04
2500mm X 1250mm X 3.0mm	25.57

Aluminium Shate



Aluminium Shate Alloy 1050A H14

Size	KG/Sheet
2000mm X 1000mm X 4.0mm	21.60
3000mm X 1000mm X 4.0mm	32.52
2500mm X 1250mm X 4.0mm	34.21
3000mm X 1250mm X 4.0mm	40.65
2000mm X 1000mm X 5.0mm	27.00
2500mm X 1250mm X 5.0mm	42.77
2500mm X 1250mm X 6.0mm	51.32
2000mm X 1000mm X 6.0mm	32.85

Aluminium Shate Alloy 5083 O/H111

Size	KG/Sheet
2500mm X 1250mm X 4.0mm	33.71
3000mm X 1500mm X 4.0mm	48.60
2500mm X 1250mm X 5.0mm	42.14
3000mm X 1500mm X 5.0mm	60.70
2500mm X 1250mm X 6.0mm	50.56
3000mm X 1500mm X 6.0mm	72.90
2500mm X 1250mm X 8.0mm	67.42
3000mm X 1500mm X 8.0mm	97.56
3000mm X 1500mm X 10.0mm	121.90

Aluminium Shate Alloy 5251 H22

Size	KG/Sheet
2000mm X 1000mm X 4.0mm	21.7
2500mm X 1250mm X 4.0mm	34.0
3000mm X 1500mm X 4.0mm	48.9
2000mm X 1000mm X 5.0mm	27.2
2500mm X 1250mm X 5.0mm	42.5
3000mm X 1500mm X 5.0mm	61.1
2000mm X 1000mm X 6.0mm	32.6
2500mm X 1250mm X 6.0mm	50.9
3000mm X 1500mm X 6.0mm	73.4

Aluminium Shate Alloy 6082 T6/T651

Size	KG/Sheet
2500mm X 1250mm X 4.0mm	34.09
2500mm X 1250mm X 5.0mm	42.61
2500mm X 1250mm X 6.0mm	51.13
2500mm X 1250mm X 8.0mm	68.18

Aluminium Shate Alloy 5454

Size/Temp	KG/Sheet
3048mm X 2032mm X 4.76mm (10ft X 6ft 8in)	80
3600mm X 2000mm X 4.76mm	H34 93
2515mm X 1829mm X 6mm (8ft 3in X 6ft)	H111 71
2595mm X 1874mm X 6mm	H24 79
2489mm X 1524mm X 6.2mm (8ft 2in X 5ft)	H22 64
2489mm X 1524mm X 6.2mm (8ft 2in X 5ft)	H34 64

Plate



Aluminium Plate Alloy 5083 O/H111

Size	KG/Plate
2500mm X 1250mm X 10.0mm	85
2500mm X 1250mm X 12.0mm	102
2500mm X 1250mm X 15.0mm	127
2500mm X 1250mm X 20.0mm	170
2500mm X 1250mm X 25.0mm	212

Plate



Aluminium Plate Alloy 6082 T651

Size	KG/Plate
2500mm X 1250mm X 10.0mm	85
2500mm X 1250mm X 12.0mm	102

Treadplate



Aluminium 5-Bar Treadplate Alloy 5754 H114

Size	KG/Plate
2438mm x 1219mm x 1.95mm	16.5
2438mm X 1219mm X 2.0mm	17.8
2500mm X 1250mm X 2.0mm	18.7
3000mm X 1500mm X 2.0mm	26.8
2438mm x 1219mm x 2.95mm	24.9
2000mm X 1000mm X 3.0mm	17.3
2438mm X 1219mm X 3.0mm	25.7
2500mm X 1250mm X 3.0mm	27.0
3000mm X 1500mm X 3.0mm	38.9
2438mm x 1219mm x 4.4mm	37.2
2000mm X 1000mm X 4.5mm	25.0
2438mm X 1219mm X 4.5mm	37.2
2500mm X 1250mm X 4.5mm	39.2
3000mm X 1500mm X 4.5mm	56.3
2438mm X 1219mm X 6.0mm	49.2
2500mm X 1250mm X 6.0mm	51.7
3000mm X 1500mm X 6.0mm	74.3

Aalco TripleGrip Aluminium Treadplate Alloy 5052 H32

Size	KG/Plate
2500 X 1250 X 1.5mm	13.9
2500 X 1250 X 2.0mm	18.1
2500 X 1250 X 3.0mm	26.6

Stucco Sheet



Aluminium Stucco Sheet Alloy 1050A H14

Size	KG/Sheet
2000mm X 1000mm X 0.5mm	2.74
2500mm X 1250mm X 0.5mm	4.28
2000mm X 1000mm X 0.6mm	3.29
2500mm X 1250mm X 0.6mm	5.13
2000mm X 1000mm X 0.7mm	3.83
2500mm X 1250mm X 0.7mm	5.99
2000mm X 1000mm X 0.8mm	4.38
2500mm X 1250mm X 0.8mm	6.84
3000mm X 1250mm X 0.9mm	9.24
3000mm X 1500mm X 0.9mm	11.1
2500mm X 1250mm X 1.0mm	8.55
2500mm X 1250mm X 1.2mm	10.3
3000mm X 1250mm X 1.2mm	12.3
3000mm X 1500mm X 1.2mm	14.8

Painted Sheet



Aluminium Painted Sheet, Alloy 3105/3003 H44 VC1 - White Painted and Vinyl Coated One Side

Size	KG/Sheet
2000mm X 1000mm X 0.5mm	2.80
2500mm X 1250mm X 0.5mm	4.30
2000mm X 1000mm X 0.6mm	3.30
2500mm X 1250mm X 0.6mm	5.20
2500mm X 1250mm X 0.9mm	7.62
2500mm X 1250mm X 1.2mm	10.20
2500mm X 1250mm X 1.5mm	12.80
2500mm X 1250mm X 2.0mm	15.50

Aalcopanel Aluminium Composite Panels



All panels are 3mm thick overall comprising a PE Thermoplastic Core and two Skins of Aluminium Alloy 1100 The Aluminium Skins are finished with Polyester Paint Both painted Skins are PVC Coated with Hi-Tack 50 micron film These panels are for INDOOR USE ONLY

Size	Aluminium Skin Thickness (mm)	Paint Colour (RAL)	Gloss Level Front*	Gloss Level reverse*	Weight per sheet (kg)
2440 x 1220 x 3	0.3	White - 9016	85%	45%	11.40
3050 x 1500 x 3	0.3	White - 9016	85%	45%	17.40
2440 x 1220 x 3	0.3	Black - 9005	85%	45%	11.40
3050 x 1500 x 3	0.3	Black - 9005	85%	45%	17.40
2440 x 1220 x 3	0.3	Silver - 9006	Brushed	45%	11.40
3050 x 1500 x 3	0.3	Silver - 9006	Brushed	45%	17.40

RAL colours are also available

*KEY
85% = High Gloss
45% = Matt

Hoarding Board

All panels are 3mm thick overall comprising a PE Thermoplastic Core and two Skins of Aluminium Alloy 1100 This Item has only one side painted, in Matt White, with the reverse being mill finish aluminium Both Skins are PVC Coated with Hi-Tack 50 micron film

Size	Aluminium Skin Thickness (mm)	Paint Colour (RAL)	Gloss Level Front	Gloss Level reverse	Weight per sheet (kg)
2440 x 1220 x 3	0.21	White - 9016	Matt	Mill Finish Aluminium	10.00

Aluminium

Round Bar



Aluminium Round Bar Alloy 6026 T9

Size	KG/Metre
3/8" DIA (9.525mm)	0.19
7/16" DIA (11.112mm)	0.26
1/2" DIA (12.7mm)	0.34
16mm DIA	0.54
3/4" DIA (19.05mm)	0.77
20mm DIA	0.85
7/8" DIA (22.225mm)	1.05
1" DIA (25.4mm)	1.37
1 1/8" DIA (28.58mm)	1.73
1 1/4" DIA (31.75mm)	2.14
35mm DIA	2.60
1 1/2" DIA (38.1mm)	3.08
40mm DIA	3.52
1 5/8" DIA (41.28mm)	3.61
1 3/4" DIA (44.45mm)	4.19
2" DIA (50.8mm)	5.47
2 1/4" DIA (57.15mm)	6.93
2 3/8" DIA (60.33)	7.72
2 1/2" DIA (63.5mm)	8.55
3" DIA (76.2mm)	12.31
3 1/2" DIA (88.9mm)	16.76
4" DIA (101.6mm)	21.89

Aluminium Round Bar Alloy 2011 T3

Size	KG/Metre
7/16" DIA (11.112mm)	0.28
1/2" DIA (12.7mm)	0.36
9/16" DIA (14.287mm)	0.46
5/8" DIA (15.875mm)	0.56
3/4" DIA (19.05mm)	0.81
7/8" DIA (22.225mm)	1.10
1 1/16" DIA (17.462mm)	0.68
1 3/16" DIA (20.637mm)	0.95
1" DIA (25.4mm)	1.44
1 1/8" DIA (28.58mm)	1.82
1 1/4" DIA (31.75mm)	2.25
1 5/16" DIA (33.337mm)	2.48
1 3/8" DIA (34.93mm)	2.72
1 1/2" DIA (38.1mm)	3.24
1 5/8" DIA (41.28mm)	3.80
1 3/4" DIA (44.45mm)	4.41
1 7/8" DIA (47.65mm)	5.06
2" DIA (50.8mm)	5.76
2 1/4" DIA (57.15mm)	7.29
2 1/2" DIA (63.5mm)	8.99
2 5/8" DIA (66.67mm)	9.92
2 3/4" DIA (69.85mm)	10.88
3" DIA (76.2mm)	12.95
3 1/4" DIA (82.55mm)	15.20
3 1/2" DIA (88.9mm)	17.63
4" DIA (101.6mm)	23.02
4 1/2" DIA (114.3mm)	29.14

Round Bar



Aluminium Round Bar Alloy 6082 T6

Size	KG/Metre
1/4" DIA (6.35mm)	0.09
5/16" DIA (7.937mm)	0.13
3/8" DIA (9.525mm)	0.19
1/2" DIA (12.7mm)	0.34
5/8" DIA (15.875mm)	0.53
3/4" DIA (19.05mm)	0.77
7/8" DIA (22.225mm)	1.05
1" DIA (25.4mm)	1.37
1 1/8" DIA (28.58mm)	1.73
1 1/4" DIA (31.75mm)	2.14
1 3/8" DIA (34.93mm)	2.59
1 1/2" DIA (38.1mm)	3.08
1 5/8" DIA (41.28mm)	3.61
1 3/4" DIA (44.45mm)	4.19
1 7/8" DIA (47.65mm)	4.81
2" DIA (50.8mm)	5.47
2 1/8" DIA (53.975mm)	6.18
2 1/4" DIA (57.15mm)	6.93
2 3/8" DIA (60.33mm)	7.72
2 1/2" DIA (63.5mm)	8.55
2 5/8" DIA (66.67mm)	9.43
2 3/4" DIA (69.85mm)	10.35
3" DIA (76.2mm)	12.31
3 1/4" DIA (82.55mm)	14.45
3 1/2" DIA (88.9mm)	16.76
3 3/4" DIA (95.25mm)	19.24
4" DIA (101.6mm)	21.89
4 1/4" DIA (107.95mm)	24.71
4 1/2" DIA (114.3mm)	27.70
4 3/4" DIA (120.65mm)	30.87
5" DIA (127.0mm)	34.20
5 1/4" DIA (133.35mm)	37.71
5 1/2" DIA (139.7mm)	41.39
5 3/4" DIA (146.05mm)	45.23
6" DIA (152.4mm)	49.25
6 1/2" DIA (165.1mm)	57.80
7" DIA (177.8mm)	67.04
7 1/4" DIA (184.15mm)	71.91
7 1/2" DIA (190.5mm)	76.96
8" DIA (203.2mm)	87.56
8 1/2" DIA (215.9mm)	98.85
9" DIA (228.6mm)	110.82
9 1/2" DIA (241.3mm)	123.47
10" DIA (254.0mm)	136.81
12" DIA (304.8mm)	197.01
13" DIA (330.20mm)	231.21
14" DIA (355.60mm)	268.15
15" DIA (381.0mm)	307.83
16" DIA (406.40mm)	350.24

Flat Bar



Aluminium Flat Bar Alloy 6082 T6

Size	KG/Metre
3/8" X 1/4"	0.16
1/2" X 1/4"	0.22
1/2" X 3/8"	0.33
5/8" X 1/8"	0.14
5/8" X 3/16"	0.20
5/8" X 1/4"	0.27
5/8" X 3/8"	0.41
5/8" X 1/2"	0.54
3/4" x 1/16"	0.08
3/4" X 1/8"	0.16
3/4" X 3/16"	0.24
3/4" X 1/4"	0.33
3/4" X 3/8"	0.49
3/4" X 1/2"	0.65
3/4" X 5/8"	0.82
1" X 1/8"	0.22
1" X 3/16"	0.33
1" X 1/4"	0.44
1" X 5/16"	0.54
1" X 3/8"	0.65
1" X 1/2"	0.87
1" X 5/8"	1.09
1" X 3/4"	1.31
1 1/4" X 1/8"	0.27
1 1/4" X 3/16"	0.41
1 1/4" x 1/16"	0.68
1 1/4" X 1/4"	0.54
1 1/4" X 3/8"	0.82
1 1/4" X 1/2"	1.09
1 1/4" X 5/8"	1.36
1 1/4" X 3/4"	1.63
1 1/4" X 1"	2.18
1 1/2" X 1/8"	0.33
1 1/2" X 3/16"	0.49
1 1/2" X 1/4"	0.65
1 1/2" x 5/16"	0.82
1 1/2" X 3/8"	0.98
1 1/2" X 1/2"	1.31
1 1/2" X 5/8"	1.63
1 1/2" X 3/4"	1.96
1 1/2" X 1"	2.61
1 1/2" X 1 1/4"	3.27
1 3/4" x 1/8"	0.38
1 3/4" X 1/4"	0.76
1 3/4" X 3/8"	1.14
1 3/4" X 1/2"	1.52
1 3/4" X 3/4"	2.29
1 3/4" X 1"	3.05
1 3/4" X 1 1/4"	3.81
1 3/4" x 1 1/2"	4.57
2" X 1/8"	0.44
2" X 3/16"	0.65
2" X 1/4"	0.87
2" x 5/16"	1.09
2" X 3/8"	1.31
2" X 1/2"	1.74
2" X 5/8"	2.18
2" X 3/4"	2.61
2" X 1"	3.48
2" X 1 1/4"	4.35
2" X 1 1/2"	5.23
2" x 1 3/4"	6.10
2 1/4" x 1/4"	0.98
2 1/4" x 1/2"	1.96

Aluminium

Flat Bar



Aluminium Flat Bar Alloy 6082 T6 (continued)

Size	KG/Metre
2¼" x 1¼"	4.90
2½" x ¾"	0.82
2½" x ½"	0.54
2½" x ¼"	1.09
2½" x ⅜"	1.63
2½" x ½"	2.18
2½" x ⅝"	2.72
2½" x ¾"	3.27
2½" x 1"	4.35
2½" x 1¼"	5.44
2½" x 1½"	6.53
2½" x 1¾"	7.62
2½" x 2"	8.71
3" x ⅜"	0.98
3" x ¼"	1.31
3" x ⅝"	1.96
3" x ½"	2.61
3" x ⅞"	3.27
3" x 1"	5.23
3" x 1¼"	6.53
3" x 1½"	7.84
3" x 1¾"	9.15
3" x 2"	10.45
3" x 2½"	13.06
3½" x ¼"	1.52
3½" x ⅝"	3.81
3½" x ½"	3.05
3½" x ¾"	4.57
3½" x 1"	6.10
3½" x 1¼"	7.62
3½" x 1½"	9.15
4" x ⅙"	0.87
4" x ⅜"	1.31
4" x ¼"	1.74
4" x ⅝"	2.61
4" x ½"	3.48
4" x ⅞"	4.36
4" x ¾"	5.23
4" x 1"	6.97
4" x 1¼"	8.71
4" x 1½"	10.45
4" x 1¾"	12.19
4" x 2"	13.94
5" x ¼"	2.18
5" x ⅜"	3.27
5" x ½"	4.35
5" x ¾"	6.53
5" x 1"	8.71
5" x 2"	17.42
6" x ⅙"	1.31
6" x ¼"	2.61
6" x ⅜"	3.92
6" x ½"	5.23
6" x ⅝"	6.53
6" x ¾"	7.84
6" x 1"	10.45
6" x 1½"	15.68
6" x 2"	20.90
8" x ¼"	3.48
8" x ½"	6.97

Flat Bar



Aluminium Flat Bar Alloy 6082 T6 (metric)

Size	KG/Metre
20mm x 10mm	0.54
30mm x 10mm	0.81
30mm x 12mm	0.97
40mm x 5mm	0.54
40mm x 10mm	1.08
50mm x 8mm	1.08
50mm x 10mm	1.35
60mm x 10mm	1.62
60mm x 30mm	4.86
60mm x 40mm	6.48
70mm x 20mm	3.78
80mm x 12mm	2.59
100mm x 5mm	1.35
100mm x 6mm	1.62
100mm x 8mm	2.16
100mm x 20mm	5.40
120mm x 10mm	3.24
120mm x 20mm	6.48
150mm x 8mm	3.24
200mm x 6mm	3.24
200mm x 8mm	4.32
200mm x 10mm	5.40

Aluminium Flat Bar Alloy 6063A T6

Size	KG/Metre
½" x ⅙"	0.11
½" x ⅜"	0.16
⅝" x ⅙"	0.19
1" x ⅙"	0.11
1" x ⅙"	0.22
1" x ⅜"	0.33
1½" x ⅙"	0.33
2" x ⅙"	0.44
3" x ⅙"	0.65
4" x ⅙"	0.87

Square Bar



Aluminium Square Bar Alloy 6082 T6

Size	KG/Metre
¼" SQUARE	0.11
⅙" SQUARE	0.17
⅜" SQUARE	0.25
½" SQUARE	0.44
⅝" SQUARE	0.68
¾" SQUARE	0.98
⅞" SQUARE	1.34
1" SQUARE	1.74
1¼" SQUARE	2.72
1½" SQUARE	3.92
1¾" SQUARE	5.34
2" SQUARE	6.97
2½" SQUARE	10.90
3" SQUARE	15.80
3½" SQUARE	21.40
4" SQUARE	27.90

Channel



Aluminium Channel Alloy 6063/6063A T6

Size	KG/Metre
⅜" x ⅜" x ⅙" x ⅙"	0.11
½" x ½" x ⅙" x ⅙"	0.15
½" x ½" x ⅙" x ⅙"	0.27
⅝" x ⅝" x ⅙" x ⅙"	0.19
⅝" x ⅝" x ⅙" x ⅙"	0.35
¾" x ¾" x ⅙" x ⅙"	0.23
¾" x ¾" x ⅙" x ⅙"	0.44
⅞" x ⅞" x ⅙" x ⅙"	0.52
1" x ½" x ⅙" x ⅙"	0.38
1" x ¾" x ⅙" x ⅙"	0.49
1" x 1" x ⅙" x ⅙"	0.31
1" x 1" x ⅙" x ⅙"	0.60
1¼" x ¾" x ⅙" x ⅙"	0.55
1¼" x 1" x ⅙" x ⅙"	0.65
1¼" x 1¼" x ⅙" x ⅙"	0.76
1½" x ¾" x ⅙" x ⅙"	0.60
1½" x 1½" x ⅙" x ⅙"	0.93
1¾" x 1" x ⅙" x ⅙"	0.76
2" x ½" x ⅙" x ⅙"	0.60
2" x ¾" x ⅙" x ⅙"	0.71
2" x 1" x ⅙" x ⅙"	0.82
2" x 1" x ⅙" x ⅙"	1.18
2" x 1½" x ⅙" x ⅙"	1.04
2" x 2" x ⅙" x ⅙"	1.25
2½" x 1" x ⅙" x ⅙"	0.93
4" x 2" x ⅙" x ⅙"	1.69

Aluminium Channel Alloy 6082 T6

Size	KG/Metre
1¼" x 1¼" x ⅙" x ⅙"	0.76
1½" x ½" x ⅙" x ⅙"	0.49
1½" x 1" x ⅙" x ⅙"	0.71
1½" x 1½" x ⅙" x ⅙"	0.93
1½" x 1½" x ⅙" x ⅙"	1.35
1½" x 1½" x ⅙" x ⅙"	1.74
2" x 1" x ⅙" x ⅙"	0.82
2" x 1" x ¼" x ¼"	1.52
2" x 1½" x ¼" x ¼"	1.96
2" x 2" x ⅙" x ⅙"	1.84
2" x 2" x ¼" x ¼"	2.40
2¼" x 1¼" x ⅙" x ⅙"	1.43
2½" x 1¼" x ⅙" x ⅙"	1.51
3" x 1" x ⅙" x ⅙"	1.04
3" x 1½" x ⅙" x ⅙"	1.25
3" x 1½" x ⅙" x ⅙"	1.84
3" x 2" x ⅙" x ⅙"	2.67
3" x 2" x ⅙" x ⅙"	1.47
3" x 2" x ⅙" x ⅙"	2.16
3" x 2" x ¼" x ¼"	2.83
3½" x 1½" x ⅙" x ⅙"	2.95
4" x 2" x ⅙" x ⅙"	3.65
5" x 2" x ⅙" x ⅙"	4.08
6" x 2" x ⅙" x ⅙"	4.52
6" x 3" x ¼" x ⅙"	6.21
6" x 3" x ⅙" x ⅙"	8.49
8" x 3" x ⅙" x ⅙"	9.80
10" x 3" x ⅙" x ⅙"	11.10

Aluminium

Equal Angle



Aluminium Equal Angle Alloy 6082 T6

Size	KG/Metre
1/2" X 1/2" X 1/8"	0.19
3/4" X 3/4" X 1/8"	0.30
1" X 1" X 1/8"	0.41
1" X 1" X 3/16"	0.59
1" X 1" X 1/4"	0.76
1 1/4" X 1 1/4" X 1/8"	0.52
1 1/4" X 1 1/4" X 3/16"	0.75
1 1/4" X 1 1/4" X 1/4"	0.98
1 1/2" X 1 1/2" X 1/8"	0.63
1 1/2" X 1 1/2" X 3/16"	0.92
1 1/2" X 1 1/2" X 1/4"	1.20
1 3/4" X 1 3/4" X 3/16"	1.08
1 3/4" X 1 3/4" X 1/4"	1.42
2" X 2" X 1/8"	0.85
2" X 2" X 3/16"	1.24
2" X 2" X 1/4"	1.63
2" X 2" X 3/8"	2.37
2 1/2" X 2 1/2" X 3/16"	1.57
2 1/2" X 2 1/2" X 1/4"	2.07
3" X 3" X 1/8"	1.28
3" X 3" X 3/16"	1.90
3" X 3" X 1/4"	2.50
3" X 3" X 3/8"	3.68
4" X 4" X 1/4"	3.37
4" X 4" X 3/8"	4.98
6" X 6" X 1/2"	10.02

Aluminium Equal Angle Alloy 6063A T6

Size	KG/Metre
1/2" X 1/2" X 1/16"	0.10
5/8" X 5/8" X 1/16"	0.13
3/8" X 3/8" X 1/8"	0.25
3/4" X 3/4" X 1/16"	0.16
3/4" X 3/4" X 1/8"	0.30
7/8" X 7/8" X 1/8"	0.35
25mm X 25mm X 3mm	0.38
1" X 1" X 1/16"	0.21
1" X 1" X 1/8"	0.41
1 1/4" X 1 1/4" X 1/16"	0.27
1 1/4" X 1 1/4" X 1/8"	0.52
1 1/2" X 1 1/2" X 1/16"	0.32
1 1/2" X 1 1/2" X 1/8"	0.63
1 3/4" X 1 3/4" X 1/8"	0.74
50mm X 50mm X 3mm	0.79
2" X 2" X 1/16"	0.43
2" X 2" X 1/8"	0.85
2" X 2" X 3/16"	1.24
2 1/2" X 2 1/2" X 1/8"	1.06

Unequal Angle



Aluminium UN-Equal Angle Alloy 6063A T6

Size	KG/Metre
3/4" X 1/2" X 1/16"	0.13
3/4" X 1/2" X 1/8"	0.25
1" X 1/2" X 1/16"	0.16
1" X 1/2" X 1/8"	0.30
1" X 3/8" X 1/8"	0.33
1" X 3/8" X 1/16"	0.18
1" X 3/8" X 1/8"	0.35
1 1/4" X 1/2" X 1/8"	0.35
1 1/4" X 3/4" X 1/8"	0.41
1 1/4" X 1" X 1/8"	0.46
1 1/2" X 3/4" X 1/8"	0.46
1 1/2" X 1" X 1/8"	0.52
1 3/4" X 1" X 1/8"	0.57
2" X 1/2" X 1/8"	0.52
2" X 3/8" X 1/8"	0.57
50mm X 25mm X 3.0mm	0.58
2" X 1" X 1/8"	0.63
2" X 1 1/2" X 1/8"	0.74
2 1/2" X 1" X 1/8"	0.74
3" X 2" X 1/8"	1.06
4" X 1" X 1/8"	1.06
4" X 2" X 1/8"	1.28

Aluminium UN-Equal Angle Alloy 6082 T6

Size	KG/Metre
1 1/2" X 1" X 1/8"	0.52
2" X 1" X 1/8"	0.63
2" X 1" X 3/16"	0.92
2" X 1" X 1/4"	1.20
2" X 1 1/2" X 1/8"	0.74
2" X 1 1/2" X 3/16"	1.08
2" X 1 1/2" X 1/4"	1.41
2 1/2" X 1 1/2" X 3/16"	1.24
2 1/2" X 1 1/2" X 1/4"	1.63
3" X 1" X 1/8"	0.85
3" X 1" X 1/4"	1.64
3" X 1 1/2" X 1/8"	0.95
3" X 1 1/2" X 3/16"	1.41
3" X 1 1/2" X 1/4"	1.85
3" X 2" X 1/8"	1.06
3" X 2" X 3/16"	1.57
3" X 2" X 1/4"	2.07
4" X 2" X 1/4"	2.50
4" X 3" X 1/4"	2.94
6" X 3" X 3/8"	5.64

Tee Section



Aluminium Tee Alloy 6063A T6

Size	KG/Metre
3/4" X 3/4" X 1/8"	0.30
1" X 1" X 1/8"	0.41
1 1/4" X 1 1/4" X 1/8"	0.52
1 1/2" X 1 1/2" X 1/8"	0.63
2" X 1" X 1/8"	0.63
2" X 2" X 1/8"	0.85

Aluminium Tee Alloy 6082 T6

Size	KG/Metre
1 1/2" X 1 1/2" X 3/16"	0.92
1 1/2" X 1 1/2" X 1/4"	1.20
2" X 2" X 3/16"	1.25
2" X 2" X 1/4"	1.63
3" X 3" X 1/4"	2.51

Aluminium

Round Tube



Aluminium Tube Alloy 6082 T6

Size	KG/Metre
½" O/D X 10SWG	0.26
¾" O/D X 10SWG	0.35
¾" O/D X 10SWG	0.44
¾" O/D X 10SWG	0.52
1" O/D X 16SWG	0.33
1" O/D X 10SWG	0.61
1" O/D X ¾"	0.83
1" O/D X ¼"	1.03
1½" O/D X 10SWG	0.70
1¼" O/D X 16SWG	0.40
1¼" O/D X ¾"	1.10
1¼" O/D X 10SWG	0.80
1¾" O/D X 10SWG	0.87
1½" O/D X 10SWG	0.96
1½" O/D X ¾"	1.35
1½" O/D X ¼"	1.71
1¾" O/D X 10SWG	1.00
1¾" O/D X ¾"	1.50
1¾" O/D X 16SWG	0.59
1¾" O/D X 10SWG	1.14
1¾" O/D X 10SWG	1.22
2" O/D X 16SWG	0.70
2" O/D X 10SWG	1.30
2" O/D X ¾"	1.90
2" O/D X ¼"	2.40
2¼" O/D X 16SWG	0.77
2¼" O/D X 10SWG	1.49
2½" O/D X 16SWG	0.90
2½" O/D X 10SWG	1.60
2½" O/D X ¾"	2.40
2½" O/D X ¼"	3.10
2½" O/D X ¾"	4.40
3½" O/D X ¼"	4.45
2¾" O/D X 10SWG	1.80
3" O/D X 16SWG	1.00
3" O/D X 10SWG	2.00
3" O/D X ¾"	2.90
3" O/D X ¼"	3.80
3½" O/D X 16SWG	1.21
3½" O/D X 10SWG	2.36
4" O/D X 10SWG	2.71
4" O/D X ¼"	5.13
4½" O/D X 10SWG	3.00
4½" O/D X ¼"	5.80
5" O/D X 10SWG	3.30
5" O/D X ¼"	6.50
6" O/D X 10SWG	4.03
6" O/D X ¼"	7.90
6½" O/D X ¼"	8.55

Round Tube



Aluminium Tube Alloy 6063 T6

Size	KG/Metre
¾" O/D X 16SWG	0.11
½" O/D X 18SWG	0.12
½" O/D X 16SWG	0.15
¾" O/D X 18SWG	0.15
¾" O/D X 16SWG	0.20
¾" O/D X 18SWG	0.18
¾" O/D X 16SWG	0.24
¾" O/D X 10SWG	0.44
¾" O/D X 18SWG	0.22
¾" O/D X 16SWG	0.28
¾" O/D X 10SWG	0.52
1" O/D X 18SWG	0.25
1" O/D X 10SWG	0.61
1½" O/D X 16SWG	0.37
1¼" O/D X 18SWG	0.32
1¼" O/D X 16SWG	0.40
1¼" O/D X 10SWG	0.80
1¾" O/D X 16SWG	0.46
1½" O/D X 18SWG	0.38
1½" O/D X 16SWG	0.50
1½" O/D X 10SWG	0.96
1¾" O/D X 16SWG	0.50
2" O/D X 16SWG	0.70
2" O/D X 10SWG	1.30
2¼" O/D X 10SWG	1.49
3" O/D X 10SWG	2.00
4" O/D X 16SWG	1.38
4" O/D X 16SWG	1.38

Round Tube - for rainwater handling

Aluminium Tube Alloy 6082 T6 (BS1474)

Size	KG/Metre
1¾" OD X 10SWG	1.14
2" OD X ¼"	2.39
2" OD X ¾"	1.86
2" OD X 1.5mm	0.63
3" OD X 1.5mm	0.95
3 ½" OD X ¼"	4.45
4" OD X 16SWG	1.38
4" OD X 1.5mm	1.27
100mm OD X 2mm	1.66
150mm OD X 2mm	2.51
152mm OD X 2.5mm	3.17
2" OD X 3.0mm	1.22
3" OD X 3.0mm	1.87
3½" OD X ¼"	4.45
4" OD X 3.0mm	2.51

Scaffold Tube

Scaffold tube is drift tested to BS 1139

Size	KG/Metre
1 ²⁹ / ₃₂ o/d x 7swg (0.176"/4.47mm)	1.53

Box Section - Square



Aluminium Square Tube Alloy 6082 T6

Size	KG/Metre
½" SQ X 16SWG	0.20
¾" SQ X 16SWG	0.31
1" SQ X 16SWG	0.42
1" SQ X 10SWG	0.78
1¼" SQ X 16SWG	0.53
1¼" SQ X 10SWG	1.00
1½" SQ X 16SWG	0.64
1½" SQ X 10SWG	1.22
1¾" SQ X 10SWG	1.45
2" SQ X 16SWG	0.87
2" SQ X 10SWG	1.67
2½" SQ X 10SWG	2.12
3" SQ X 10SWG	2.56

Aluminium Square Tube Alloy 6082 T6

Size	KG/Metre
50mm X 50mm X 1.5mm	0.79
50mm X 50mm X 3.0mm	1.52
75mm X 75mm X 1.5mm	1.19
100mm X 100mm X 1.5mm	1.60
100mm X 100mm X 2.0mm	2.12
150mm X 150mm X 3.0mm	4.76

Aluminium Square Tube Alloy 6063 T6

Size	KG/Metre
1" SQ X 10SWG	0.78
1¼" SQ X 16SWG	0.53
1½" SQ X 10SWG	1.22
2" SQ X 10SWG	1.67
2" SQ X ¼"	3.05
4" SQ X 10SWG	3.45
4" SQ X ¼"	6.53

Box Section - Rectangular



Aluminium Rectangular Tube Alloy 6063 T6

Size	KG/Metre
1½" X ¾" X ¼"	0.46
1½" X 1" X 16SWG	0.53
1½" X 1" X 10SWG	1.00
50mm X 25mm X 3.0mm	1.18
2" X 1" X 10SWG	1.22
2" X 1½" X 10SWG	1.45
3" X 1" X 10SWG	1.67
3" X 1½" X 10SWG	1.89
3" X 2" X 10SWG	2.11
4" X 1" X 10SWG	2.11
4" X 1¾" X 10SWG	2.45
4" X 2" X 10SWG	2.56
6" X 2" X 10SWG	3.45
6" X 3" X ¾"	10.80

Aluminium

Mouldings



These are a selection of the many shapes available and may not be shown at actual size

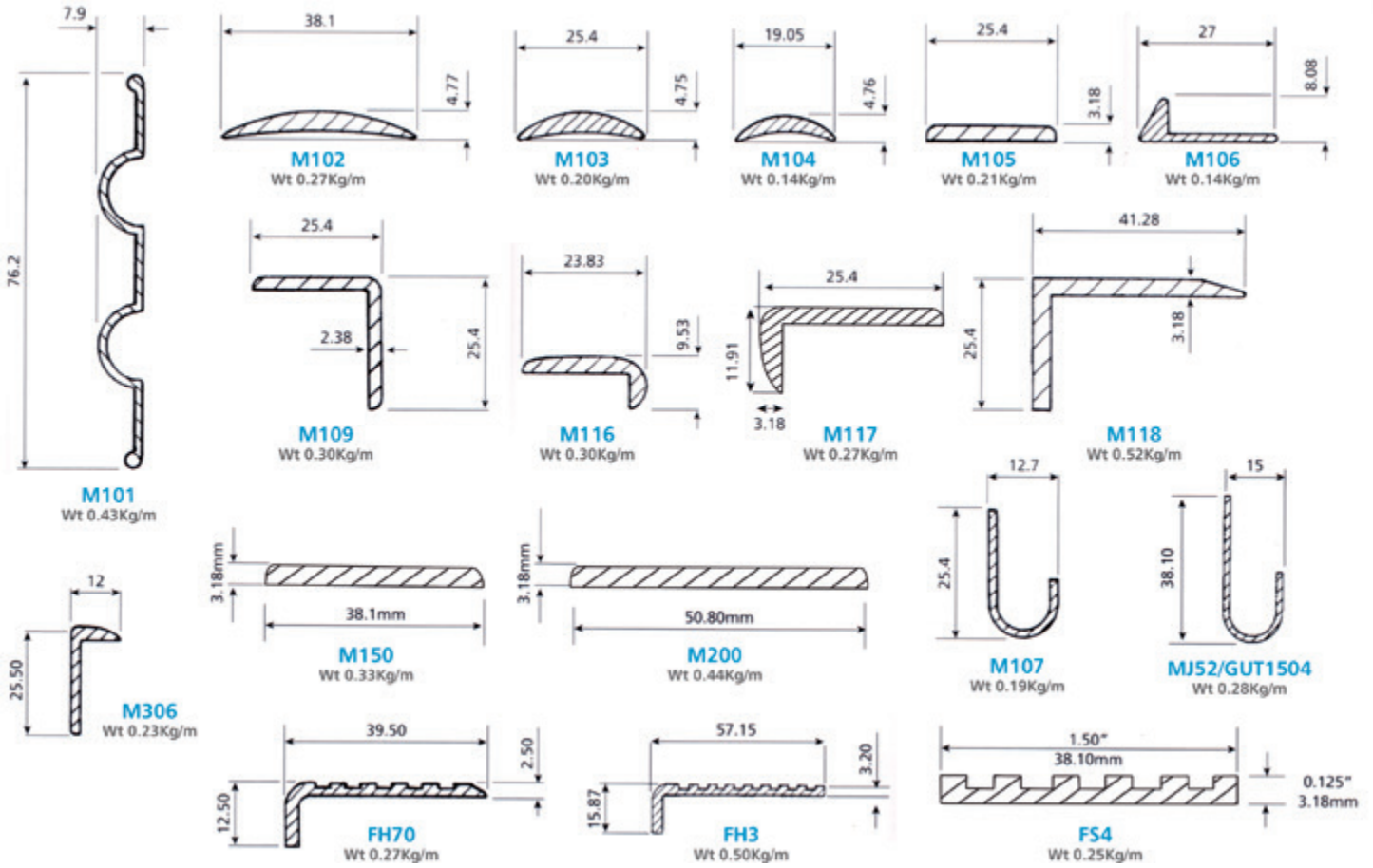

Aluminium

Road Transport Products

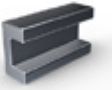

The Aalco stock of products for the Road Transport Industry is expanding rapidly, making Aalco the fastest growing supplier to this sector. Whatever you require: a single length of aluminium extrusion; flooring in aluminium, stainless, wood or laminate; GRP sheet; Dropside systems, through to complete body kits – Aalco can supply quickly and efficiently. Please call your local service centre for information, advice, prices and delivery times.

A full range of products for RT Bodies including:

- Flooring - See next page
- Roofing - Aluminium & GRP Roof Coil, Radius & Square Castings, Aluminium & Galvanised Steel Roofsticks
- Runners & Bearers
- Side Raves
- Pedestrian Side Guard Kits - VCA approved in single rail and double rail design
- Corner Pillars - Including GRP Captive Pillars
- Cant Rails
- Top Hats
- Dropside Body Components
- Door Cappings
- Corner Castings
- GRP Panels
- GRP Box System Components
- Mouldings - See page 11
- Load-Lok Track
- Accessories including Adhesives & Tapes
- Steel sections - Runners, Bearers, Corner Pillars, Inner/Outer Panels, Rear Frames & Headers, End Caps, Curtain Track



Aalco stocks an extensive range of products for the RT sector, covered in a separate catalogue available from your local Service Centre

Aluminium

Road Transport Products - Flooring



AalcoMesh

AalcoMesh is a top quality, mesh-patterned birch plywood panel that has been most commonly available on the market for many years. With very good slip and wear resistance and a long life the AalcoMesh pattern remains the most popular choice for many RT flooring applications.

Thickness available: 9mm – 30mm

Sheet Size (mm)
1220mm X 2500mm
1220mm X 3050mm
1500mm X 3000mm
1525mm X 3050mm
1525mm X 2440mm
1525mm X 3300mm

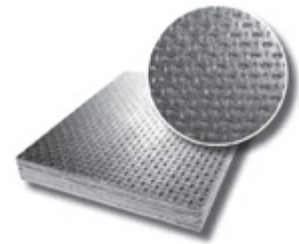

Aalco Hexagrip

Aalco HexaGrip offers an improved slip and wear resistance combined with a decorative appearance of hexa pattern. Quality birch plywood overlaid with 220g/m² phenolic film to the face, backed with 120g/m² balancer, makes Aalco HexaGrip an excellent RT flooring panel.

Thickness available: 9mm – 30mm

Sheet Size (mm)
1220mm X 2500mm
1220mm X 3050mm
1500mm X 3000mm
1525mm X 3050mm
1525mm X 2440mm
1525mm X 3300mm

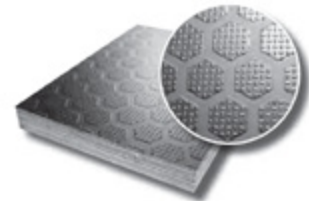

AalcoTrans

AalcoTrans is a solution for demanding RT flooring applications where anti-slip properties and high wear resistance are the most desired factors. Manufactured in Europe, AalcoTrans offers the durability of birch plywood combined with the special, hard wearing thick multi layer film with the imprinted waffle (square) pattern which offer one of the highest Taber Value on the market, over 10,000 rounds (based on independent lab test).

Sheet Size (mm)	Thickness (mm)	Weight/Sheet (kg)
1220 X 2500	18	43
1220 X 3050	24	48

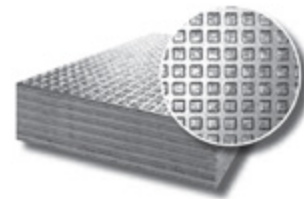

Aalco stocks a full range of products for flooring construction including runners, bearers and flooring materials. Detailed here is the range of Plywood Base Phenolic Coated Mesh Flooring.

Other types of flooring material available from stock include:

- Aluminium Floor Planks
- EGL Laminate
- Keruing Half Lap Planking
- Aluminium Treadplate (see page 6)

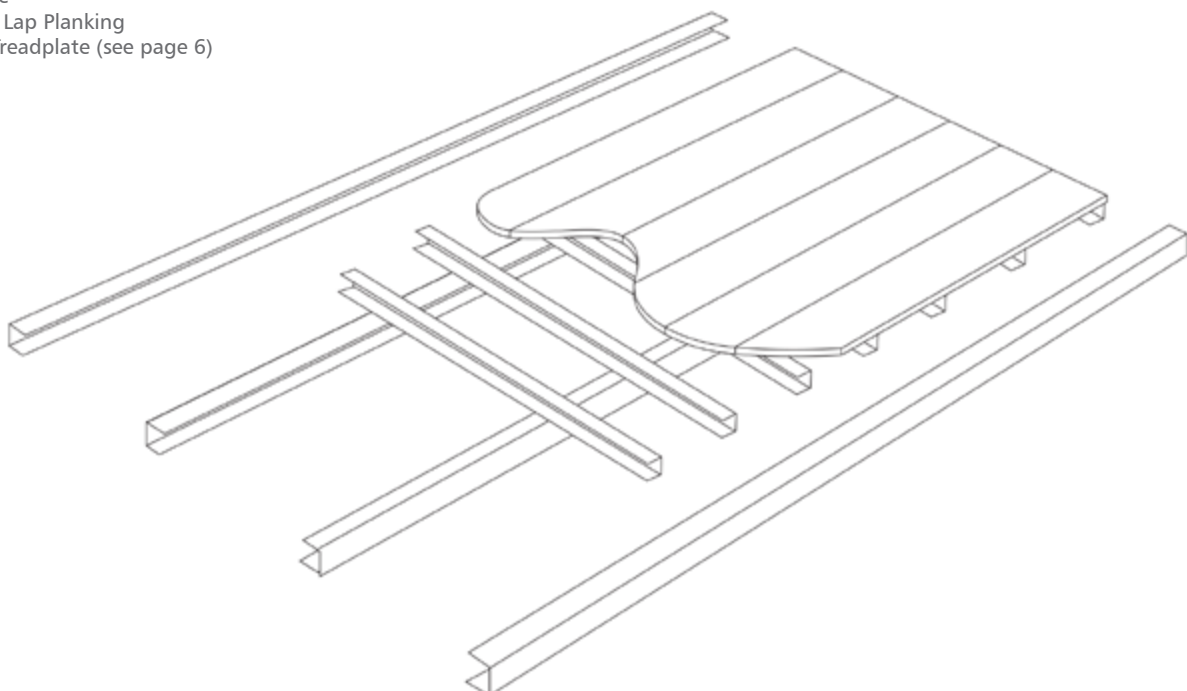

Aluminium

Road Transport Products



Aalco stocks an extensive range of products for the RT sector, covered in a separate catalogue available from your local Service Centre

Aalco GRP Box Products

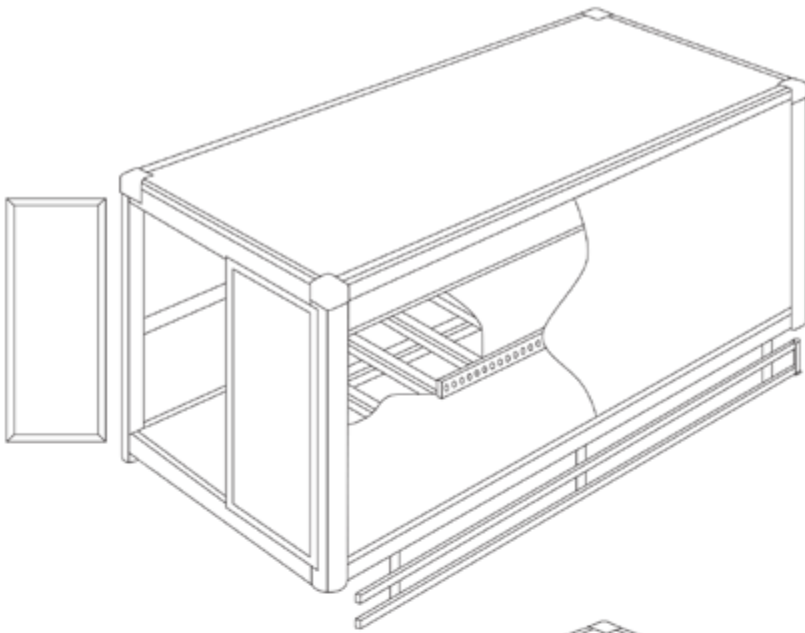

Aalco GRP Box Products:

- GRP Panels
- Runners & Bearers - Aluminium & Steel
- Flooring
- Captive Corner Pillars & Castings
- Roofing Coil - Aluminium & GRP

Aalco Curtainside Products

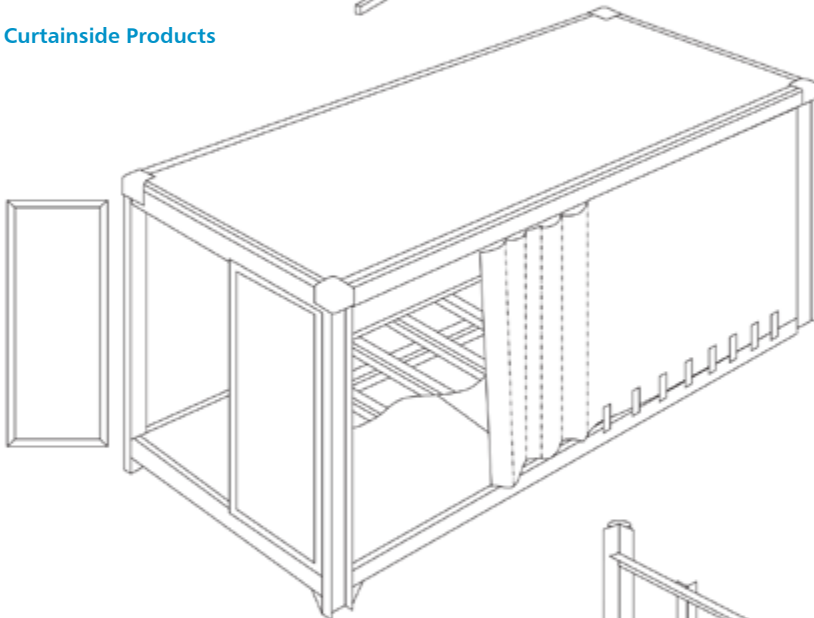

Aalco Curtainside Products:

- Runners & Bearers - Aluminium & Steel
- Flooring
- Corner Pillars & Castings
- Roofing Coil - Aluminium & GRP
- Cant Rails
- Headers
- Cappings
- Curtain Track

Aalco Dropside Products

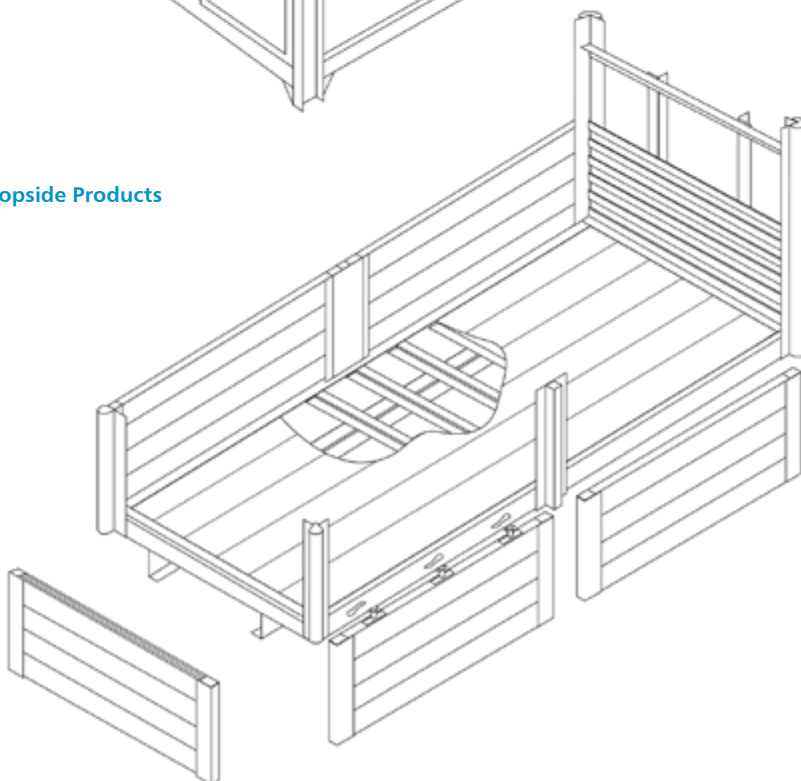





Aalco Dropside Products: Standard and Lightweight Systems including:

- Runners & Bearers - Aluminium & Steel
- Flooring
- Side Planks - One piece or Sets
- Hinges
- Anti-Luce fastening Lugs
- Corner & Centre Pillars - Aluminium and Steel
- End Caps - Aluminium and Steel

Stainless Steel Products

- Sheet..... 16
- Plate..... 17
- Circle Polished Sheet 17
- Treadplate 17
- Equal Angle..... 17
- Square Bar..... 17
- Hexagon Bar..... 17
- Round Bar 18
- Flat Bar - Rolled Edge 19
- Structural & Decorative Tube - Round 20
- Slotted Tube System and fittings..... 20
- Handrail Tube and Fittings..... 21
- Glass U 22
- Accessories - Adhesive & Cleaners 22
- Structural & Decorative Tube - Square 23
- Structural & Decorative Tube - Rectangular. 24
- Pipe 25
- Butt Weld Fittings 25
- Flanges..... 27
- High Pressure Fittings - Threaded 28
- High Pressure Fittings - Socket Weld 28
- Seamless Tube 29
- Metric Tube and Fittings..... 29
- BSP Fittings 30
- Hygenic Tube and Fittings 30

Metals Main Index

- Aluminium  04
- Stainless Steel  15
- Brass  32
- Copper  34
- Bronze  35

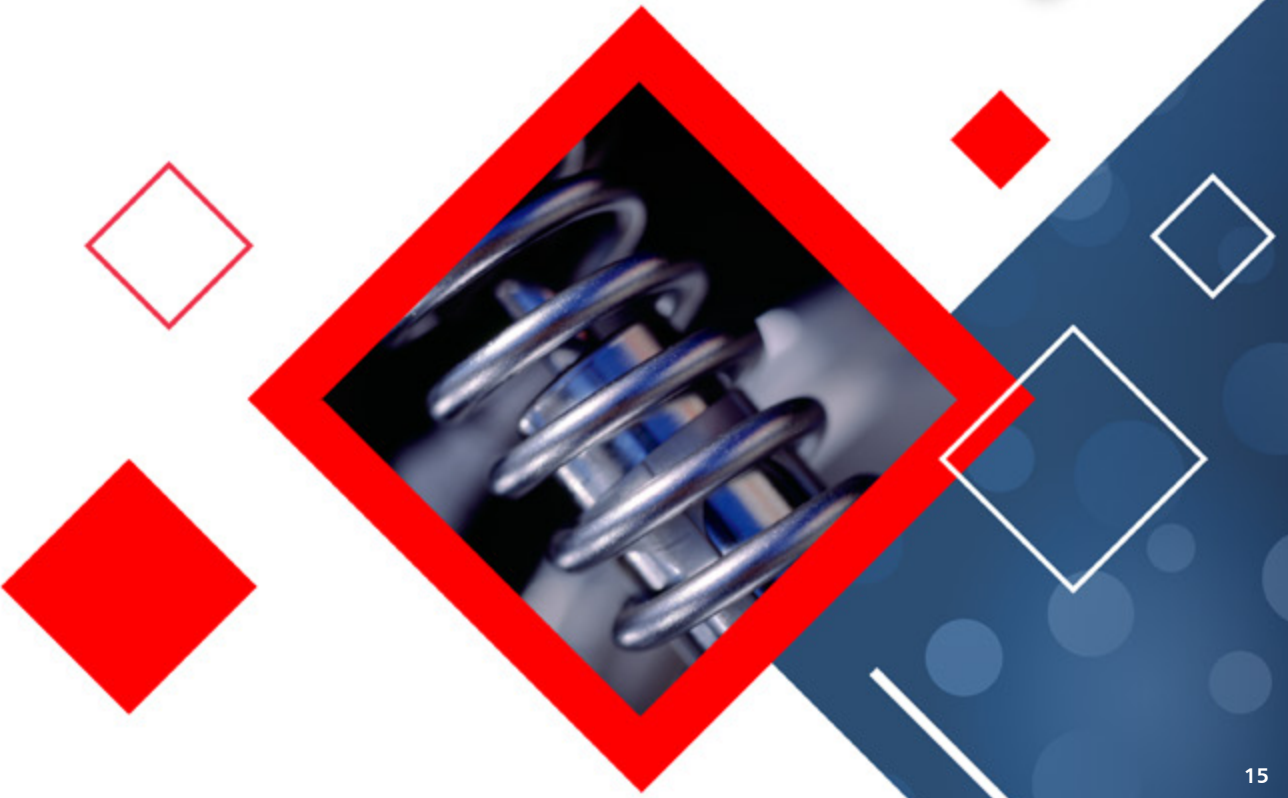

Stainless Steel

Sheet



Stainless Steel Sheet Grade 1.4301 (304) - 2B

Size	KG/Sheet
2000mm X 1000mm X 0.5mm	8.2
2500mm X 1250mm X 0.5mm	12.8
2000mm X 1000mm X 0.7mm	11.5
2500mm X 1250mm X 0.7mm	17.9
2500mm X 1250mm X 0.8mm	20.5
2000mm X 1000mm X 0.9mm	14.7
2500mm X 1250mm X 0.9mm	23.0
3000mm X 1500mm X 0.9mm	33.2
2000mm X 1000mm X 1.0mm	16.4
2500mm X 1250mm X 1.0mm	25.6
2000mm X 1000mm X 1.2mm	19.6
2500mm X 1250mm X 1.2mm	30.7
3000mm X 1500mm X 1.2mm	44.2
2000mm X 1000mm X 1.5mm	24.6
2500mm X 1250mm X 1.5mm	38.4
3000mm X 1500mm X 1.5mm	55.3
2000mm X 1000mm X 2.0mm	32.7
2500mm X 1250mm X 2.0mm	51.2
3000mm X 1500mm X 2.0mm	73.7
4000mm X 2000mm X 2.0mm	128.0
2000mm X 1000mm X 2.5mm	40.9
2500mm X 1250mm X 2.5mm	63.9
3000mm X 1500mm X 2.5mm	92.1
2000mm X 1000mm X 3.0mm	49.6
2500mm X 1250mm X 3.0mm	77.5
3000mm X 1500mm X 3.0mm	111.6
4000mm X 2000mm X 3.0mm	192.0

Stainless Steel Sheet Grade 1.4404 (316L) - 2B

Size	KG/Sheet
2000mm X 1000mm X 0.7mm	11.5
2500mm X 1250mm X 0.7mm	17.9
2000mm X 1000mm X 0.9mm	14.7
2500mm X 1250mm X 0.9mm	23.0
2000mm X 1000mm X 1.2mm	19.6
2500mm X 1250mm X 1.2mm	30.7
3000mm X 1500mm X 1.2mm	44.2
2000mm X 1000mm X 1.5mm	24.6
2500mm X 1250mm X 1.5mm	38.4
3000mm X 1500mm X 1.5mm	55.3
2000mm X 1000mm X 2.0mm	32.7
2500mm X 1250mm X 2.0mm	51.2
3000mm X 1500mm X 2.0mm	73.7
4000mm X 2000mm X 2.0mm	128.0
2000mm X 1000mm X 2.5mm	40.9
2500mm X 1250mm X 2.5mm	63.9
3000mm X 1500mm X 2.5mm	92.1
2000mm X 1000mm X 3.0mm	49.6
2500mm X 1250mm X 3.0mm	77.5
3000mm X 1500mm X 3.0mm	111.6
4000mm X 2000mm X 3.0mm	192.0

Sheet



Stainless Steel Sheet Grade 1.4016 (430) - Bright Annealed

Size	KG/Sheet
2000mm X 1000mm X 0.5mm	8.2
2500mm X 1250mm X 0.5mm	12.8
2000mm X 1000mm X 0.7mm	11.5
2500mm X 1250mm X 0.7mm	17.9
2000mm X 1000mm X 0.9mm	14.7
2500mm X 1250mm X 0.9mm	23.0
2000mm X 1000mm X 1.0mm	16.4
2500mm X 1250mm X 1.0mm	25.6
2000mm X 1000mm X 1.2mm	19.6
2500mm X 1250mm X 1.2mm	30.7
2000mm X 1000mm X 1.5mm	24.6
2500mm X 1250mm X 1.5mm	38.4
2000mm X 1000mm X 2.0mm	32.7
2500mm X 1250mm X 2.0mm	51.2

Stainless Steel Sheet Grade 1.4301 (304) - Bright Annealed

Size	KG/Sheet
2500mm X 1250mm X 0.5mm	12.8
2000mm X 1000mm X 0.5mm	8.2
2000mm X 1000mm X 0.6mm	9.8
2500mm X 1250mm X 0.6mm	15.3
2000mm X 1000mm X 0.7mm	11.5
2500mm X 1250mm X 0.7mm	17.9
2500mm X 1250mm X 0.8mm	20.5
2000mm X 1000mm X 0.9mm	14.7
2500mm X 1250mm X 0.9mm	23.0
2000mm X 1000mm X 1.0mm	16.4
2500mm X 1250mm X 1.0mm	25.6
2000mm X 1000mm X 1.2mm	19.6
2500mm X 1250mm X 1.2mm	30.7
2000mm X 1000mm X 1.5mm	24.6
2500mm X 1250mm X 1.5mm	38.4
2000mm X 1000mm X 2.0mm	32.7
2500mm X 1250mm X 2.0mm	51.2

Stainless Steel Sheet Grade 1.4301 (304) - OPTISHEEN™ Polished and PVC Coated 1 Side

Size	KG/Sheet
2000mm X 1000mm X 0.9mm	14.7
2500mm X 1250mm X 0.9mm	23.0
2000mm X 1000mm X 1.2mm	19.6
2500mm X 1250mm X 1.2mm	30.7
2000mm X 1000mm X 1.5mm	24.6
2500mm X 1250mm X 1.5mm	38.4
3000mm X 1500mm X 1.5mm	55.3
2500mm X 1250mm X 2.0mm	51.2

Stainless Steel Sheet Grade 1.4301 (304) - 240 Grit Silicon Polished and PVC Coated 1 Side

Size	KG/Sheet
2000mm X 1000mm X 0.9mm	14.7
2500mm X 1250mm X 0.9mm	23.0
2000mm X 1000mm X 1.2mm	19.6
2500mm X 1250mm X 1.2mm	30.7
2000mm X 1000mm X 1.5mm	24.6
2500mm X 1250mm X 1.5mm	38.4
2000mm X 1000mm X 2.0mm	32.7
2500mm X 1250mm X 2.0mm	51.2

Sheet



Stainless Steel Sheet Grade 1.4016 (430) - Polished 240 Grit and PVC Coated 1 Side

Size	KG/Sheet
2500mm X 1250mm X 0.7mm	17.9
2000mm X 1000mm X 0.9mm	14.7
2500mm X 1250mm X 0.9mm	23.0
2000mm X 1000mm X 1.2mm	19.6
2500mm X 1250mm X 1.2mm	30.7
2000mm X 1000mm X 1.5mm	24.6
2500mm X 1250mm X 1.5mm	38.4

Stainless Steel Sheet Grade 1.4404 (316L) - Polished 240 Grit and PVC Coated 1 Side

Size	KG/Sheet
2500mm X 1250mm X 0.9mm	23.0
2500mm X 1250mm X 1.2mm	31.2
2500mm X 1250mm X 1.5mm	38.4
3000mm X 1500mm X 1.5mm	55.3
2500mm X 1250mm X 2.0mm	51.2
2500mm X 1250mm X 3.0mm	77.5

Stainless Steel Sheet Grade 1.4301 (304) - Polished 240 Grit and PVC Coated 1 Side

Size	KG/Sheet
2000mm X 1000mm X 0.7mm	11.5
2500mm X 1250mm X 0.7mm	17.9
2000mm X 1000mm X 0.9mm	14.7
2500mm X 1250mm X 0.9mm	23.0
3000mm X 1500mm X 0.9mm	33.2
2000mm X 1000mm X 1.0mm	16.4
2500mm X 1250mm X 1.0mm	25.6
2000mm X 1000mm X 1.2mm	19.6
2500mm X 1250mm X 1.2mm	30.7
3000mm X 1500mm X 1.2mm	44.2
2000mm X 1000mm X 1.5mm	24.6
2500mm X 1250mm X 1.5mm	38.4
3000mm X 1500mm X 1.5mm	55.3
2000mm X 1000mm X 2.0mm	32.7
2500mm X 1250mm X 2.0mm	51.2
3000mm X 1500mm X 2.0mm	73.7
2000mm X 1000mm X 2.5mm	40.9
2500mm X 1250mm X 2.5mm	63.9
3000mm X 1500mm X 2.5mm	92.1
2000mm X 1000mm X 3.0mm	49.6
2500mm X 1250mm X 3.0mm	77.5
3000mm X 1500mm X 3.0mm	111.6

Stainless Steel Sheet Grade 1.4003 - Cold Rolled except where shown

Size	KG/Sheet
2500mm X 1250mm X 1.0mm	25.0
2000mm X 1000mm X 1.2mm	19.2
2500mm X 1250mm X 1.2mm	30.0
2000mm X 1000mm X 1.5mm	24.0
2500mm X 1250mm X 1.5mm	37.5
3000mm X 1500mm X 1.5mm	54.0
2000mm X 1000mm X 2.0mm	32.0
2500mm X 1250mm X 2.0mm	50.0
3000mm X 1500mm X 2.0mm	72.0
2500mm X 1250mm X 2.5mm	62.5
2000mm X 1000mm X 3.0mm (HR)	48.0
2500mm X 1250mm X 3.0mm (HR)	75.0
3000mm X 1500mm X 3.0mm (HR)	108.0

Stainless Steel

Plate



Stainless Steel Hot Rolled Plate Grade 1.4003

Size	KG/Plate
2000mm X 1000mm X 3.0mm	48
2500mm X 1250mm X 3.0mm	75
3000mm X 1500mm X 3.0mm	108
2000mm X 1000mm X 4.0mm	64
2500mm X 1250mm X 4.0mm	100
3000mm X 1500mm X 4.0mm	144
2000mm X 1000mm X 5.0mm	80
2500mm X 1250mm X 5.0mm	125
2500mm X 1250mm X 6.0mm	150
3000mm X 1500mm X 6.0mm	216
2500mm X 1250mm X 8.0mm	200
3000mm X 1500mm X 8.0mm	288
2500mm X 1250mm X 10.0mm	250
3000mm X 1500mm X 10.0mm	360
2500mm X 1250mm X 12.0mm	300
3000mm X 1500mm X 12.0mm	432

Stainless Steel Cold Rolled Plate Grades 1.4307 (304L) & 1.4404 (361L) PVC Coated 1 Side

Size	KG/Plate
4000mm X 2000mm X 4.0mm	256
4000mm X 2000mm X 5.0mm	320
4000mm X 2000mm X 6.0mm	384

Stainless Steel Hot Rolled Plate Grades 1.4307 (304L) & 1.4404 (316L)

Size	KG/Plate
2000mm X 1000mm X 3.0mm	48
2500mm X 1250mm X 3.0mm	75
3000mm X 1500mm X 3.0mm	108
2000mm X 1000mm X 4.0mm	64
2500mm X 1250mm X 4.0mm	100
3000mm X 1500mm X 4.0mm	144
2000mm X 1000mm X 5.0mm	80
2500mm X 1250mm X 5.0mm	125
3000mm X 1500mm X 5.0mm	180
4000mm X 2000mm X 5.0mm	320
2000mm X 1000mm X 6.0mm	96
2500mm X 1250mm X 6.0mm	150
3000mm X 1500mm X 6.0mm	216
4000mm X 2000mm X 6.0mm	384
6000mm X 2000mm X 6.0mm	576
2000mm X 1000mm X 8.0mm	128
2500mm X 1250mm X 8.0mm	200
3000mm X 1500mm X 8.0mm	288
4000mm X 2000mm X 8.0mm	512
2000mm X 1000mm X 10.0mm	160
2500mm X 1250mm X 10.0mm	250
3000mm X 1500mm X 10.0mm	360
4000mm X 2000mm X 10.0mm	640
6000mm X 2000mm X 10.0mm	960
2500mm X 1250mm X 12.0mm	300
3000mm X 1500mm X 12.0mm	432
4000mm X 2000mm X 12.0mm	768
2500mm X 1250mm X 15.0mm	375
3000mm X 1500mm X 15.0mm	557
2500mm X 1250mm X 20.0mm	500
3000mm X 1500mm X 20.0mm	720
2500mm X 1250mm X 25mm	625
3000mm X 1500mm X 25mm	900
2500mm X 1250mm X 30mm	750
3000mm X 1500mm X 30mm	1080

Plate

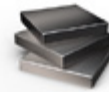

Stainless Steel Cold Rolled Plate Grades 1.4307 (304L) & 1.4404 (316L)

Size	KG/Plate
2000mm X 1000mm X 4.0mm	64
2500mm X 1250mm X 4.0mm	100
3000mm X 1500mm X 4.0mm	144
2000mm X 1000mm X 5.0mm	80
2500mm X 1250mm X 5.0mm	125
3000mm X 1500mm X 5.0mm	180
2000mm X 1000mm X 6.0mm	96
2500mm X 1250mm X 6.0mm	150
3000mm X 1500mm X 6.0mm	216

Circle Polished Sheet



Circle Polished Stainless Steel Sheet Grade 1.4301 (304) - 50mm Circles

Size	KG/Sheet
2500mm x 1250mm x 0.9mm	23.0
2500mm x 1250mm x 1.2mm	30.7
2500mm x 1250mm x 1.5mm	38.4
2500mm x 1250mm x 2.0mm	51.2

Circle Polished Stainless Steel Sheet Grade 1.4016 (430) - 50mm Circles

Size	KG/Sheet
2500mm x 1250mm x 0.9mm	23.0

Treadplate



Stainless Steel Treadplate BSEN 10088: Part 3 / ASTM A793 / DIN 59220 (T) Pattern 1 Grade AISI 304

Size	KG/Plate
3000mm X 1000mm X 3.0mm	78
3000mm X 1250mm X 3.0mm	98
3000mm X 1250mm X 4.5mm	143
3000mm X 1250mm X 6.0mm	180

Equal Angle



Stainless Steel Angle Grades 1.4307 (304L) & 1.4404 (316L)

Size	KG/Metre
20.0mm X 20.0mm X 3.0mm	0.95
25.0mm X 25.0mm X 3.0mm	1.20
25.0mm X 25.0mm X 5.0mm	1.92
25.0mm X 25.0mm X 6.0mm	2.25
30.0mm X 30.0mm X 3.0mm	1.46
30.0mm X 30.0mm X 5.0mm	2.35
30.0mm X 30.0mm X 6.0mm	2.76
40.0mm X 40.0mm X 3.0mm	1.97
40.0mm X 40.0mm X 5.0mm	3.20
40.0mm X 40.0mm X 6.0mm	3.79
50.0mm X 50.0mm X 3.0mm	2.48
50.0mm X 50.0mm X 5.0mm	4.05
50.0mm X 50.0mm X 6.0mm	4.81
50.0mm X 50.0mm X 10.0mm	7.68
60.0mm X 60.0mm X 5.0mm	4.91
60.0mm X 60.0mm X 6.0mm	5.84
60.0mm X 60.0mm X 10.0mm	9.39
70.0mm X 70.0mm X 6.0mm	6.86
70.0mm X 70.0mm X 10.0mm	11.10
75.0mm X 75.0mm X 6.0mm	7.37
75.0mm X 75.0mm X 10.0mm	11.95
80.0mm X 80.0mm X 6.0mm	7.88
80.0mm X 80.0mm X 10.0mm	12.80
100.0mmX100.0mm X 6.0mm	9.93
100.0mmX100.0mm X 10.0mm	16.21

Square Bar



Stainless Steel Hot Rolled Square Bar Grade 1.4307/304L

Size	KG/Metre
12.0mm SQ	1.14
16.0mm SQ	2.02
20.0mm SQ	3.16
25.0mm SQ	4.94
30.0mm SQ	7.11
40.0mm SQ	12.64
50.0mm SQ	19.75

Stainless Steel Hot Rolled Square Bar Grade 1.4404/316L

Size	KG/Metre
12.0mm SQ	1.15
16.0mm SQ	2.04
20.0mm SQ	3.18
25.0mm SQ	4.98
30.0mm SQ	7.16
1½" SQ	11.55
40.0mm SQ	12.74
50.0mm SQ	19.90

Hexagon Bar



Stainless Steel Hexagon Bar Grade 1.4305 (303)

Size	KG/Metre
0.3125" A/F	0.43
0.437" A/F	0.84
0.500" A/F	1.10
0.562" A/F	1.39
0.625" A/F	1.73
0.750" A/F	2.48
0.820" A/F	2.97
0.875" A/F	3.38
0.937" A/F	3.88
1.010" A/F	4.50
1.125" A/F	5.59
1.250" A/F	6.90

Stainless Steel Hexagon Bar Grade 1.4404 (316L)

Size	KG/Metre
0.500" A/F	1.11
0.562" A/F	1.40
0.625" A/F	1.74
17.0mm A/F	1.99
0.750" A/F	2.50
0.820" A/F	2.99
0.875" A/F	3.41
0.920" A/F	3.76
1.010" A/F	4.54
1.101" A/F	5.39
1.125" A/F	5.63
1.200" A/F	6.40
1.250" A/F	6.95
1.300" A/F	7.52
1.375" A/F	8.41
1.480" A/F	9.74
1.500" A/F	10.0
1.670" A/F	12.4
1.860" A/F	15.4
2.500" A/F	27.8

Stainless Steel

Round Bar



Stainless Steel Round Bar Grade 1.4305 (303)

Size	KG/Metre
3.0mm DIA	0.06
1/8" DIA (3.175mm)	0.06
4.0mm DIA	0.10
3/16" DIA (4.762mm)	0.14
5.0mm DIA	0.16
6.0mm DIA	0.22
1/4" DIA (6.35mm)	0.25
7.0mm DIA	0.30
5/16" DIA (7.937mm)	0.39
8.0mm DIA	0.40
3/8" DIA (9.525mm)	0.56
10.0mm DIA	0.62
7/16" DIA (11.112mm)	0.77
12.0mm DIA	0.89
1/2" DIA (12.7mm)	1.00
14.0mm DIA	1.22
9/16" DIA (14.287mm)	1.27
15.0mm DIA	1.40
5/8" DIA (15.875mm)	1.56
16.0mm DIA	1.59
11/16" DIA (17.462mm)	1.89
18.0mm DIA	2.01
3/4" DIA (19.05mm)	2.25
20.0mm DIA	2.48
22.0mm DIA	3.00
7/8" DIA (22.225mm)	3.07
24.0mm DIA	3.57
25.0mm DIA	3.88
1" DIA (25.4mm)	4.00
1 1/16" DIA (28.575mm)	5.07
30.0mm DIA	5.58
1 1/4" DIA (31.75mm)	6.25
1 3/16" DIA (34.925mm)	7.57
35.0mm DIA	7.60
1 1/2" DIA (38.1mm)	9.01
40.0mm DIA	9.93
1 5/8" DIA (41.275mm)	10.6
1 3/4" DIA (44.45mm)	12.3
45.0mm DIA	12.6
1 7/8" DIA (47.625mm)	14.1
50.0mm DIA	15.5
2" DIA (50.8mm)	16.0
2 1/8" DIA (53.975mm)	18.1
2 1/4" DIA (57.15mm)	20.3
60.0mm DIA	22.3
2 3/8" DIA (60.325mm)	22.6
2 1/2" DIA (63.5mm)	25.0
2 5/8" DIA (66.67mm)	27.6
2 3/4" DIA (69.85mm)	30.3
3" DIA (76.2mm)	36.0
3 1/4" DIA (82.55mm)	42.9
3 1/2" DIA (88.9mm)	49.8
3 3/4" DIA (95.25mm)	57.1
4" DIA (101.6mm)	65.0
4 1/4" DIA (107.95mm)	73.4
4 1/2" DIA (114.3mm)	82.3
5" DIA (127.0mm)	102
5 3/4" DIA (146.05mm)	134
6" DIA (152.4mm)	146
7" DIA (177.8mm)	199

Round Bar



Stainless Steel Round Bar Grades 1.4307 (304L) & 1.4404 (316L)

Size	KG/Metre
3.0mm DIA	0.06
1/8" DIA (3.175mm)	0.06
4.0mm DIA	0.10
3/16" DIA (4.762mm)	0.14
5.0mm DIA	0.16
6.0mm DIA	0.22
1/4" DIA (6.35mm)	0.25
5/16" DIA (7.937mm)	0.39
8.0mm DIA	0.40
3/8" DIA (9.525mm)	0.56
10.0mm DIA	0.62
7/16" DIA (11.112mm)	0.77
12.0mm DIA	0.89
1/2" DIA (12.7mm)	1.00
14.0mm DIA	1.23
9/16" DIA (14.287mm)	1.27
15.0mm DIA	1.40
5/8" DIA (15.875mm)	1.56
16.0mm DIA	1.59
11/16" DIA (17.462mm)	1.91
18.0mm DIA	2.03
3/4" DIA (19.05mm)	2.25
20.0mm DIA	2.48
7/8" DIA (22.225mm)	3.07
24.0mm DIA	3.60
25.0mm DIA	3.88
1" DIA (25.4mm)	4.00
1 1/16" DIA (28.575mm)	5.07
30.0mm DIA	5.58
1 1/4" DIA (31.75mm)	6.25
32.0mm DIA	6.40
1 3/8" DIA (34.925mm)	7.57
35.0mm DIA	7.60
1 1/2" DIA (38.1mm)	9.01
40.0mm DIA	9.93
1 5/8" DIA (41.275mm)	10.6
1 3/4" DIA (44.45mm)	12.3
1 7/8" DIA (47.625mm)	14.2
45.0mm DIA	12.7
50.0mm DIA	15.5
2" DIA (50.8mm)	16.0
2 1/8" DIA (53.975mm)	18.2
2 1/4" DIA (57.15mm)	20.3
60.0mm DIA	22.3
2 3/8" DIA (60.325mm)	22.8
2 1/2" DIA (63.5mm)	25.0
2 5/8" DIA (66.67mm)	27.8
2 3/4" DIA (69.85mm)	30.3
3" DIA (76.2mm)	36.0
3 1/4" DIA (82.55mm)	42.9
3 1/2" DIA (88.9mm)	49.8
3 3/4" DIA (95.25mm)	57.1
4" DIA (101.6mm)	65.0
4 1/4" DIA (107.95mm)	73.4
110.0mm DIA	75.7
4 1/2" DIA (114.3mm)	82.3
115.0mm DIA	82.7
4 3/4" DIA (120.65mm)	92.4
5" DIA (127.0mm)	102
5 1/4" DIA (133.35mm)	112
5 1/2" DIA (139.7mm)	123
145mm DIA	131
5 3/4" DIA (146.05mm)	134
150.0mm DIA	145

Round Bar



Stainless Steel Round Bar Grades 1.4307 (304L) & 1.4404 (316L) (continued)

Size	KG/Metre
6" DIA (152.4mm)	146
6 1/4" DIA (158.75mm)	159
6 1/2" DIA (165.1mm)	172
7" DIA (177.8mm)	199
180.0mm DIA	203
185.0mm DIA	217
7 1/2" DIA (190.5mm)	229
8" DIA (203.2mm)	260
8 1/2" DIA (215.9mm)	294
9" DIA (228.6mm)	329
240.0mm DIA	360
9 1/2" DIA (241.3mm)	369
10" DIA (254.0mm)	406
10 1/2" DIA (266.7mm)	451
11" DIA (279.4mm)	492
12" DIA (304.8mm)	585
340.0mm DIA	728
350.0mm DIA	766
14" DIA (355.6mm)	802
375.0mm DIA	879
16" DIA (406.4mm)	1040
450.0mm DIA	1317

continued...

Stainless Steel

Flat Bar - Rolled Edge



Stainless Steel Rolled Edge Flat Bar Grades 1.4307 (304L) & 1.4404 (316L)

Size	KG/Metre
12.0mm X 3.0mm	0.28
12.0mm X 5.0mm	0.47
12.0mm X 6.0mm	0.57
20.0mm X 3.0mm	0.47
20.0mm X 5.0mm	0.79
20.0mm X 6.0mm	0.95
25.0mm X 3.0mm	0.59
25.0mm X 5.0mm	0.99
25.0mm X 6.0mm	1.19
25.0mm X 8.0mm	1.58
25.0mm X 10.0mm	1.98
30.0mm X 3.0mm	0.71
30.0mm X 5.0mm	1.19
30.0mm X 6.0mm	1.42
30.0mm X 8.0mm	1.90
30.0mm X 10.0mm	2.37
35.0mm X 6.0mm	1.66
40.0mm X 3.0mm	0.95
40.0mm X 5.0mm	1.58
40.0mm X 6.0mm	1.90
40.0mm X 8.0mm	2.53
40.0mm X 10.0mm	3.16
40.0mm X 12.0mm	3.79
45.0mm X 6.0mm	2.13
50.0mm X 3.0mm	1.19
50.0mm X 5.0mm	1.98
50.0mm X 6.0mm	2.37
50.0mm X 8.0mm	3.16
50.0mm X 10.0mm	3.95
50.0mm X 12.0mm	4.74
60.0mm X 3.0mm	1.42
60.0mm X 5.0mm	2.37
60.0mm X 6.0mm	2.84
60.0mm X 8.0mm	3.79
60.0mm X 10.0mm	4.74
60.0mm X 12.0mm	5.69
65.0mm X 6.0mm	3.08
65.0mm X 10.0mm	5.14
75.0mm X 3.0mm	1.78
75.0mm X 5.0mm	2.96
75.0mm X 6.0mm	3.56
75.0mm X 8.0mm	4.74
75.0mm X 10.0mm	5.93
75.0mm X 12.0mm	7.11
80.0mm X 6.0mm	3.79
80.0mm X 10.0mm	6.32
100.0mm X 3.0mm	2.37
100.0mm X 5.0mm	3.95
100.0mm X 6.0mm	4.74
100.0mm X 8.0mm	6.32
100.0mm X 10.0mm	7.90
100.0mm X 12.0mm	9.48
125.0mm X 6.0mm	5.93
125.0mm X 10.0mm	9.88
125.0mm X 12.0mm	11.85
150.0mm X 6.0mm	7.11
150.0mm X 8.0mm	9.48
150.0mm X 10.0mm	11.85
150.0mm X 12.0mm	14.33
200.0mm X 6.0mm	9.48
200.0mm X 8.0mm	12.64
200.0mm X 10.0mm	15.80

Flat Bar - Hot Rolled



Stainless Steel Hot Rolled Flat Bar Grade 1.4307 (304L)

Size	KG/Metre
20.0mm X 10.0mm	1.58
20.0mm X 12.0mm	1.90
25.0mm X 10.0mm	1.98
25.0mm X 12.0mm	2.37
25.0mm X 15.0mm	2.96
25.0mm X 20.0mm	3.95
30.0mm X 12.0mm	2.84
30.0mm X 15.0mm	3.56
30.0mm X 25.0mm	5.93
40.0mm X 15.0mm	4.74
40.0mm X 20.0mm	6.32
40.0mm X 25.0mm	7.90
50.0mm X 15.0mm	5.93
50.0mm X 20.0mm	7.90
50.0mm X 25.0mm	9.88
60.0mm X 15.0mm	7.11
60.0mm X 20.0mm	9.48
60.0mm X 25.0mm	11.9
75.0mm X 15.0mm	8.89
75.0mm X 20.0mm	11.9
75.0mm X 25.0mm	14.8
100.0mm X 15.0mm	11.9
100.0mm X 20.0mm	15.8
100.0mm X 25.0mm	19.8

Stainless Steel Hot Rolled Flat Bar Grade 1.4404 (316L)

Size	KG/Metre
20.0mm X 10.0mm	1.59
20.0mm X 12.0mm	1.91
25.0mm X 10.0mm	1.99
25.0mm X 12.0mm	2.39
25.0mm X 15.0mm	2.99
30.0mm X 12.0mm	2.87
30.0mm X 20.0mm	4.78
30.0mm X 25.0mm	5.97
40.0mm X 15.0mm	4.78
40.0mm X 20.0mm	6.37
40.0mm X 25.0mm	7.96
50.0mm X 15.0mm	5.97
50.0mm X 20.0mm	7.96
50.0mm X 25.0mm	9.95
60.0mm X 15.0mm	7.16
60.0mm X 20.0mm	9.55
75.0mm X 20.0mm	11.94
100.0mm X 15.0mm	11.94

Stainless Steel

Flat Bar - Polished



Stainless Steel Rolled Edge Polished 320G Flat Bar Grade 1.4307 (304L)

Size	KG/Metre
30mm X 5.0mm	1.22
40mm X 5.0mm	1.63
50mm X 5.0mm	2.03
60mm X 5.0mm	2.44
100mm X 5.0mm	4.07
30mm X 6.0mm	1.46
40mm X 6.0mm	1.95
50mm X 6.0mm	2.44
30mm X 8.0mm	1.95
40mm X 8.0mm	2.60
50mm X 8.0mm	3.25
60mm X 8.0mm	3.91
80mm X 8.0mm	5.21
100mm X 8.0mm	6.51
30mm X 10.0mm	2.44
40mm X 10.0mm	3.25
50mm X 10.0mm	4.07
60mm X 10.0mm	4.88
80mm X 10.0mm	6.51
100mm X 10.0mm	8.14

Stainless Steel

Structural & Decorative Tube - Round

Stainless Steel Welded Structural & Decorative Tube Grades 304 & 316 - Mirror Polish O/D

Size	KG/Metre
5/8" OD X 1.2mm	0.44
5/8" OD X 1.5mm	0.54
1/2" OD X 1.5mm	0.42
3/4" OD X 18SWG	0.54
3/4" OD X 1.5mm	0.65
7/8" OD X 1.2mm	0.63
7/8" OD X 1.5mm	0.77
7/8" OD X 2.0mm	1.00
19mm OD X 1.2mm	0.53
1" OD X 1.2mm	0.72
1" OD X 1.5mm	0.89
1" OD X 2.0mm	1.17
1 1/4" OD X 1.2mm	0.91
1 1/4" OD X 1.5mm	1.13
1 1/2" OD X 1.2mm	1.10
1 1/2" OD X 1.5mm	1.40
1 1/2" OD X 2.0mm	1.80
1 3/4" OD X 1.5mm	1.60
2" OD X 1.2mm	1.48
2" OD X 1.5mm	1.84
2" OD X 2.0mm	2.44
2" OD X 3.0mm	3.56
2 1/2" OD X 1.5mm	2.31
3" OD X 1.5mm	2.78

Stainless Steel Welded Structural & Decorative Tube Grades 304 & 316 - Brushed Finish O/D

Size	KG/Metre
3/4" OD X 1.5mm	0.65
1" OD X 1.5mm	0.89
1 1/2" OD X 1.5mm	1.36
1 1/2" OD X 2.0mm	1.79
1 1/2" OD X 3.0mm	2.61
2" OD X 1.5mm	1.84
2" OD X 2.0mm	2.42
2" OD X 3.0mm	3.56
3" OD X 3.0mm	5.45
4" OD X 3.0mm	7.34

Stainless Steel Welded Structural & Decorative Tube Grade 304 - Descaled Finish

Size	KG/Metre
25mm OD X 1.5mm	0.90
25mm OD X 2.0mm	1.14

Structural & Decorative Tube - Round

Stainless Steel Welded Structural & Decorative Tube ASTM A554 Grades 304 & 316 - Satin Polish O/D

Size	KG/Metre
1 1/2" OD X 3.0mm SATIN	2.63
2" OD X 3.0mm SATIN	3.59
3" OD X 3.0mm SATIN	5.49
4" OD X 3.0mm SATIN	7.40

Stainless Steel Welded Structural & Decorative Tube Grades 304 & 316 - Dull Polish O/D

Size	KG/Metre
3/4" OD X 1.5mm	0.65
1" OD X 1.5mm	0.89
1 1/2" OD X 1.5mm	1.36
1 1/2" OD X 2.0mm	1.79
1 1/2" OD X 3.0mm	2.61
2" OD X 1.5mm	1.84
2" OD X 2.0mm	2.42
2" OD X 3.0mm	3.56
3" OD X 3.0mm	5.45
4" OD X 3.0mm	7.34

Slotted Tube System and Fittings

Stainless Steel Slotted Handrail Tube Grades 304 & 316

Size	KG/Metre
42.2MM X 1.5MM	1.83
48.3MM X 1.5MM	2.17



Stainless Steel Glue



Stainless Steel Cleaning & Passivation Kit



90 degree angle - vertical



90 degree angle - horizontal



Connector



Rubber inserts



Slotted tube



End caps

Stainless Steel

Handrail Tube and Fittings

Stainless Steel Handrail Tube Grade 304 & 316 - Satin Polish O/D

Size	KG/Metre
1" OD X 3.0mm	1.68
2" OD X 3.0mm	3.57
3" OD X 3.0mm	5.46
4" OD X 3.0mm	7.40
42.4mm OD X 2.0mm	2.01
48.3mm OD x 2.0mm	2.32
60.3mm OD X 2.0mm	2.92
42.4mm OD X 2.5mm	2.49
48.3mm OD X 2.5mm	2.86
60.3mm OD X 2.5mm	3.61

Stainless Steel UN-ANNEALED Handrail Tube Grade 304 - Descaled Finish

Size	KG/Metre
42.2mm OD X 1.6mm 304	1.62
60.3mm OD X 1.6mm 304	2.33
76.1mm OD X 1.6mm 304	2.96
101.6mm OD X 2.0mm 304	4.94



Glass Clamps



Glass Clamp



Glass Clamp



Glass Clamp



Glass Clamp

Fittings



Adjustable Elbow



90 Degree Elbow



45 Degree Elbow



90 Degree Curved Elbow

Fittings



Flexible Elbow



Internal Connector



Crossbar Holder Intermediate



Flush Tee Connector

Fittings



4-way Corner Connector



Cross Connector



3-way Corner Connector



Adaptor

Mountings



Floor Base (indoor use)

Mountings



Floor Base (outdoor use)

Mountings



Elbow with Flange



Elbow with Flange

End Caps



Flat Cap



End Caps



End Caps with M8



End Caps

Handrail Brackets



Straight Saddle



Adjustable Saddle



Wall Support



Wall Support

Handrail Brackets



Handrail Holder



Handrail Holder



Handrail Holder

Wall Flange



Disc



End Caps



End Caps

Side Mounted Base

Side Mounted Base

Stainless Steel

Glass U - Frameless glass system for interior or exterior stairs and balconies

Accessories - Adhesive & Cleaners



Stainless Steel Cleaning & Passivation Kit

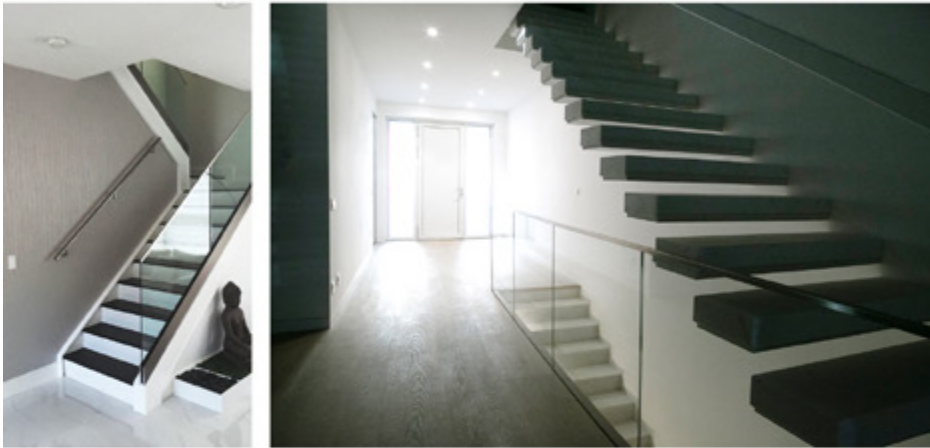

Stainless Steel Glue



Stainless Steel

Structural & Decorative Tube - Square

Stainless Steel Welded Structural & Decorative Tube Grade 1.4301 (304) - Descaled Finish

Size	KG/Metre
12.7mm X 12.7mm X 1.2mm	0.45
12.7mm X 12.7mm X 1.5mm	0.55
40mm X 40mm X 4.0mm	4.81
50mm X 50mm X 4.0mm	5.96
50mm X 50mm X 5.0mm	7.41
60mm X 60mm X 4.0mm	7.22
60mm X 60mm X 5.0mm	8.90
80mm X 80mm X 4.0mm	9.82
80mm X 80mm X 5.0mm	12.40
100mm X 100mm X 4.0mm	12.40
100mm X 100mm X 5.0mm	15.38
100mm X 100mm X 6.0mm	17.50
100mm X 100mm X 8.0mm	23.26
120mm X 120mm X 3.0mm	11.80
120mm X 120mm X 4.0mm	15.00
120mm X 120mm X 5.0mm	18.66
120mm X 120mm X 6.0mm	21.20
150mm X 150mm X 3.0mm	14.06

Stainless Steel Welded Structural & Decorative Tube Grade 1.4301 (304) - Brushed Finish O/D

Size	KG/Metre
150mm X 150mm X 4.0mm	18.62
150mm X 150mm X 5.0mm	22.40
150mm X 150mm X 6.0mm	27.36
150mm X 150mm X 8.0mm	34.30
150mm X 150mm X 10.0mm	41.65
200mm X 200mm X 3.0mm	18.62
200mm X 200mm X 5.0mm	30.40
200mm X 200mm X 6.0mm	36.09
200mm X 200mm X 8.0mm	47.10
200mm X 200mm X 10.0mm	57.60

Stainless Steel Welded Structural & Decorative Tube Grade 1.4404 (316) - Descaled Finish

Size	KG/Metre
80mm X 80mm X 4.0mm	9.82
100mm X 100mm X 4.0mm	12.40
100mm X 100mm X 5.0mm	15.38
100mm X 100mm X 6.0mm	17.50
100mm X 100mm X 8.0mm	21.60
120mm X 120mm X 4.0mm	14.77
120mm X 120mm X 5.0mm	18.66
120mm X 120mm X 6.0mm	21.20
150mm X 150mm X 4.0mm	18.60
150mm X 150mm X 5.0mm	23.08
150mm X 150mm X 6.0mm	27.51

Stainless Steel Welded Structural & Decorative Tube Grade 1.4016 (430) - Dull Polish O/D

Size	KG/Metre
25mm X 25mm X 1.2mm	0.93
30mm X 30mm X 1.2mm	1.11
30mm X 30mm X 1.5mm	1.37
40mm X 40mm X 1.5mm	1.86

Stainless Steel Welded Structural & Decorative Tube Grade 1.4301 (304) - Brushed Finish O/D

Size	KG/Metre
20mm X 20mm X 1.5mm	0.88



Stainless Steel Welded Structural & Decorative Tube Grade 1.4016 (430) - Dull Polish O/D

Size	KG/Metre
20mm X 20mm X 1.5mm	0.88
25mm X 25mm X 1.5mm	1.15
25mm X 25mm X 2.0mm	1.50
30mm X 30mm X 1.5mm	1.37
30mm X 30mm X 2.0mm	1.84
30mm X 30mm X 3.0mm	2.72
40mm X 40mm X 1.5mm	1.86
40mm X 40mm X 2.0mm	2.45
40mm X 40mm X 3.0mm	3.76
50mm X 50mm X 1.5mm	2.33
50mm X 50mm X 2.0mm	3.08
50mm X 50mm X 3.0mm	4.65
60mm X 60mm X 3.0mm	5.44
80mm X 80mm X 3.0mm	7.36
100mm X 100mm X 3.0mm	9.53
100mm X 100mm X 4.0mm	12.40

Stainless Steel Welded Structural & Decorative Tube to EN/ISO 1127 Grade 1.4509 (441) - Dull Polish O/D

Size	KG/Metre
25mm X 25mm X 1.2mm	0.93
30mm X 30mm X 1.2mm	1.11
30mm X 30mm X 1.5mm	1.37
40mm X 40mm X 1.5mm	1.86

Stainless Steel Welded Structural & Decorative Tube Grade 1.4301 (304) - Dull Polish O/D

Size	KG/Metre
12.7mm X 12.7mm X 1.2mm	0.45
12.7mm X 12.7mm X 1.5mm	0.55
15mm X 15mm X 1.2mm	0.53
15mm X 15mm X 1.5mm	0.66
20mm X 20mm X 1.2mm	0.72
20mm X 20mm X 1.5mm	0.88
20mm X 20mm X 2.0mm	1.19
25mm X 25mm X 1.2mm	0.93
25mm X 25mm X 1.5mm	1.15
25mm X 25mm X 2.0mm	1.50
25mm X 25mm X 3.0mm	2.21
30mm X 30mm X 1.2mm	1.11
30mm X 30mm X 1.5mm	1.37
30mm X 30mm X 2.0mm	1.84
30mm X 30mm X 3.0mm	2.72
40mm X 40mm X 1.2mm	1.50
40mm X 40mm X 1.5mm	1.86
40mm X 40mm X 2.0mm	2.45
40mm X 40mm X 3.0mm	3.76
50mm X 50mm X 1.5mm	2.33
50mm X 50mm X 2.0mm	3.08
50mm X 50mm X 3.0mm	4.65
60mm X 60mm X 2.0mm	3.71
60mm X 60mm X 3.0mm	5.49
70mm X 70mm X 3.0mm	6.53
80mm X 80mm X 2.0mm	4.99
80mm X 80mm X 3.0mm	7.53
100mm X 100mm X 2.0mm	6.40
100mm X 100mm X 3.0mm	9.53

Structural & Decorative Tube - Square

Stainless Steel Welded Structural & Decorative Tube Grade 304 - Brushed Finish

Size	KG/Metre
15mm x 15mm x 1.5mm	0.60
20mm x 20mm x 2.0mm	1.19
25mm x 25mm x 1.5mm	1.15
25mm x 25mm x 2.0mm	1.49
25mm x 25mm x 3.0mm	2.20
30mm x 30mm x 1.5mm	1.37
30mm x 30mm x 2.0mm	1.84
30mm x 30mm x 3.0mm	2.72
40mm x 40mm x 1.5mm	1.86
40mm x 40mm x 2.0mm	2.45
40mm x 40mm x 3.0mm	3.76
50mm x 50mm x 1.5mm	2.33
50mm x 50mm x 2.0mm	3.08
50mm x 50mm x 3.0mm	4.65
60mm x 60mm x 2.0mm	3.71
60mm x 60mm x 3.0mm	5.49
70mm x 70mm x 3.0mm	6.53
80mm x 80mm x 2.0mm	4.99
80mm x 80mm x 3.0mm	7.53
100mm x 100mm x 2.0mm	6.40
100mm x 100mm x 3.0mm	9.53

Stainless Steel Welded Structural & Decorative Tube Grade 316 - Brushed Finish

Size	KG/Metre
20mm x 20mm x 1.5mm	0.88
25mm x 25mm x 1.5mm	1.15
25mm x 25mm x 2.0mm	1.49
30mm x 30mm x 1.5mm	1.37
30mm x 30mm x 2.0mm	1.84
30mm x 30mm x 3.0mm	2.72
40mm x 40mm x 1.5mm	1.86
40mm x 40mm x 2.0mm	2.45
40mm x 40mm x 3.0mm	3.76
50mm x 50mm x 1.5mm	2.33
50mm x 50mm x 2.0mm	3.08
50mm x 50mm x 3.0mm	4.65
60mm x 60mm x 3.0mm	5.44
80mm x 80mm x 3.0mm	7.36
100mm x 100mm x 3.0mm	9.53

Stainless Steel

Structural & Decorative Tube - Rectangular



Stainless Steel Welded Structural & Decorative Tube Grade 304 - Brushed Finish

Size	KG/Metre
20mm x 10mm x 1.5mm	0.66
30mm x 10mm x 1.5mm	0.90
30mm x 15mm x 1.5mm	1.00
30mm x 20mm x 1.5mm	1.15
40mm x 15mm x 1.5mm	1.26
40mm x 20mm x 1.5mm	1.37
40mm x 20mm x 2.0mm	1.83
50mm x 25mm x 1.5mm	1.76
50mm x 25mm x 2.0mm	2.32
50mm x 25mm x 3.0mm	3.46
50mm x 30mm x 1.5mm	1.86
50mm x 30mm x 2.0mm	2.45
50mm x 30mm x 3.0mm	3.75
60mm x 20mm x 1.5mm	1.86
60mm x 30mm x 1.5mm	2.12
60mm x 30mm x 2.0mm	2.80
60mm x 30mm x 3.0mm	4.10
60mm x 40mm x 1.5mm	2.33
60mm x 40mm x 2.0mm	3.08
60mm x 40mm x 3.0mm	4.65
80mm x 40mm x 1.5mm	2.80
80mm x 40mm x 2.0mm	3.71
80mm x 40mm x 3.0mm	5.49
80mm x 60mm x 3.0mm	6.53
100mm x 40mm x 3.0mm	6.53
100mm x 50mm x 2.0mm	4.68
100mm x 50mm x 3.0mm	6.95
100mm x 60mm x 3.0mm	7.53

Stainless Steel Welded Structural & Decorative Tube Grade 304 - Descaled Finish

Size	KG/Metre
80mm X 40mm X 4.0mm	7.22
80mm X 40mm X 5.0mm	8.90
100mm X 50mm X 4.0mm	9.09
100mm X 50mm X 5.0mm	11.2
120mm X 60mm X 3.0mm	8.39
120mm X 60mm X 4.0mm	11.1
120mm X 60mm X 5.0mm	13.8
120mm X 80mm X 3.0mm	9.53
120mm X 80mm X 4.0mm	12.4
120mm X 80mm X 5.0mm	15.4
150mm X 50mm X 3.0mm	9.53
150mm X 50mm X 5.0mm	15.4
150mm X 100mm X 3.0mm	11.7
150mm X 100mm X 4.0mm	15.4
150mm X 100mm X 5.0mm	18.8
150mm X 100mm X 6.0mm	22.6
150mm X 100mm X 8.0mm	27.9
200mm X 100mm X 3.0mm	14.1
200mm X 100mm X 4.0mm	18.6
200mm X 100mm X 5.0mm	22.4
200mm X 100mm X 6.0mm	27.4
200mm X 100mm X 8.0mm	35.9
200mm X 100mm X 10.0mm	41.6
250mm X 150mm X 6.0mm	36.8
250mm X 150mm X 8.0mm	47.3

Stainless Steel Welded Structural & Decorative Tube Grade 316 - Descaled finish

Size	KG/Metre
80mm X 40mm X 4.0mm	7.2
80mm X 40mm X 5.0mm	8.9
100mm X 50mm X 5.0mm	11.1
120mm X 80mm X 3.0mm	9.5
120mm X 80mm X 5.0mm	15.4
150mm X 100mm X 3.0mm	11.7
150mm X 100mm X 4.0mm	15.4
150mm X 100mm X 5.0mm	19.1
150mm X 100mm X 6.0mm	22.6
150mm X 100mm X 8.0mm	29.8
200mm X 100mm X 4.0mm	18.6
200mm X 100mm X 5.0mm	23.1
200mm X 100mm X 6.0mm	27.5
200mm X 100mm X 8.0mm	34.3

Stainless Steel Welded Structural & Decorative Tube Grade 304 - Dull Polish O/D

Size	KG/Metre
20mm X 10mm X 1.5mm	0.66
30mm X 10mm X 1.2mm	0.73
30mm X 10mm X 1.5mm	0.90
30mm X 15mm X 1.5mm	1.00
30mm X 20mm X 1.5mm	1.15
40mm X 15mm X 1.5mm	1.26
40mm X 20mm X 1.2mm	1.11
40mm X 20mm X 1.5mm	1.37
40mm X 20mm X 2.0mm	1.84
50mm X 25mm X 1.2mm	1.42
50mm X 25mm X 1.5mm	1.76
50mm X 25mm X 2.0mm	2.32
50mm X 25mm X 3.0mm	3.46
50mm X 30mm X 1.5mm	1.86
50mm X 30mm X 2.0mm	2.45
50mm X 30mm X 3.0mm	3.76
60mm X 20mm X 1.5mm	1.86
60mm X 30mm X 1.5mm	2.12
60mm X 30mm X 2.0mm	2.80
60mm X 30mm X 3.0mm	4.13
60mm X 40mm X 1.5mm	2.33
60mm X 40mm X 2.0mm	3.08
60mm X 40mm X 3.0mm	4.65
80mm X 40mm X 1.5mm	2.80
80mm X 40mm X 2.0mm	3.71
80mm X 40mm X 3.0mm	5.49
80mm X 60mm X 3.0mm	6.53
100mm X 50mm X 2.0mm	4.68
100mm X 40mm X 3.0mm	6.53
100mm X 50mm X 3.0mm	6.95
100mm X 60mm X 3.0mm	7.53
120mm X 60mm X 3.0mm	8.39

Stainless Steel Welded Structural & Decorative Tube Grade 316 - Dull Polish O/D

Size	KG/Metre
40mm X 20mm X 1.5mm	1.37
50mm X 25mm X 1.5mm	1.76
60mm X 40mm X 2.0mm	3.06
80mm X 40mm X 2.0mm	3.71
80mm X 40mm X 3.0mm	5.49
100mm X 50mm X 2.0mm	4.68
100mm X 50mm X 3.0mm	6.95

Stainless Steel

Pipe



SEAMLESS TO ASTM A312 / ANSI B36.19

Size	304L	316L
½" SCH10S		0.28
½" SCH40S		0.37
¾" SCH10S		0.50
¾" SCH40S	0.64	0.64
1" SCH80S	0.81	0.81
¾" SCH10S	0.64	0.64
¾" SCH40S	0.86	0.86
¾" SCH80S		1.12
1½" SCH10S	1.02	1.02
1½" SCH40S	1.29	1.29
1½" SCH80S	1.65	1.65
¾" SCH10S		1.30
¾" SCH40S	1.72	1.72
¾" SCH80S	2.24	2.24
1" SCH10S	2.13	2.13
1" SCH40S	2.55	2.55
1" SCH80S	3.30	3.30
1¼" SCH40S	3.45	
1¼" SCH80S	4.55	4.55
1½" SCH5S	1.93	
1½" SCH10S	3.16	3.16
1½" SCH40S	4.12	4.12
1½" SCH80S	5.51	5.51
2" SCH10S	4.00	4.00
2" SCH40S	5.54	5.54
2" SCH80S	7.62	7.62
2½" SCH10S	5.36	5.36
2½" SCH40S	8.79	8.79
2½" SCH80S		11.60
3" SCH10S	6.57	6.57
3" SCH40S	11.50	11.50
3" SCH80S	15.60	15.60
4" SCH10S	8.52	8.52
4" SCH40S	16.40	16.40
4" SCH80S	22.70	22.70
5" SCH40S		22.20
6" SCH10S	14.10	
6" SCH40S	28.80	
6" SCH80S	43.40	43.40
8" SCH10S		20.30
8" SCH40S	43.30	43.30

SEAMLESS TO ASTM A312 / ANSI B36.10 Grade 316L

Size	KG/Metre
½" SCH160	1.99
¾" SCH160	2.95
1" SCH160	4.32
1½" SCH160	7.37
2" SCH160	11.30
3" SCH160	21.70
6" SCH10S	14.10
6" SCH40S	28.80
8" SCH80S	65.90

Pipe



WELDED TO ASTM A312 / ANSI B36.19

Size	304L	316L
½" SCH5S	0.82	0.82
½" SCH10S	1.02	1.02
½" SCH40S	1.29	1.29
¾" SCH5S	1.04	1.04
¾" SCH10S	1.30	1.30
¾" SCH40S	1.72	1.72
1" SCH5S	1.32	1.32
1" SCH10S	2.13	2.13
1" SCH40S	2.55	2.55
1¼" SCH5S	1.68	
1¼" SCH10S	2.74	2.74
1¼" SCH40S	3.45	3.45
1½" SCH5S		1.93
1½" SCH10S	3.16	3.16
1½" SCH40S	4.11	4.11
2" SCH5S	2.43	2.43
2" SCH10S	4.00	4.00
2" SCH40S	5.54	5.54
2½" SCH5S	3.76	3.76
2½" SCH10S	5.36	5.36
2½" SCH40S	8.79	8.79
3" SCH5S	4.60	4.60
3" SCH10S	6.57	6.57
3" SCH40S	11.50	11.50
3½" SCH10S	7.55	7.55
3½" SCH40S	13.80	13.80
4" SCH5S	5.94	5.94
4" SCH10S	8.52	8.52
4" SCH40S	16.40	16.40
5" SCH10S	11.80	11.80
5" SCH40S	22.20	22.20
6" SCH5S	11.50	11.50
6" SCH10S	14.10	14.10
6" SCH40S	28.80	28.80
8" SCH5S	15.10	15.10
8" SCH10S	20.30	20.30
8" SCH40S	43.30	43.30
10" SCH5S		23.10
10" SCH10S	28.30	28.30
10" SCH40S	61.40	61.40
12" SCH5S		31.90
12" SCH10S	36.70	36.70
12" SCH40S	75.20	75.20
14" SCH10S	42.10	42.10
16" SCH10S	48.20	48.20
18" SCH10S	54.30	54.30
20" SCH10S	69.90	69.90
24" SCH10S	96.20	96.20

Butt Weld Fittings



Stainless Steel Equal Tees - Seamless

Size	304L	316L
½" SCH10S EQUAL TEE		0.06
½" SCH40S EQUAL TEE	0.07	0.07
1" SCH10S EQUAL TEE	0.18	0.18
1" SCH40S EQUAL TEE	0.21	0.21
1½" SCH10S EQUAL TEE	0.40	0.40
1½" SCH40S EQUAL TEE		0.52
2" SCH10S EQUAL TEE	0.56	0.56
2" SCH40S EQUAL TEE	0.77	0.77
3" SCH10S EQUAL TEE		1.24
3" SCH40S EQUAL TEE		2.17
4" SCH10S EQUAL TEE	1.96	1.96
4" SCH80S EQUAL TEE		5.24
6" SCH10S EQUAL TEE	4.43	4.43

Stainless Steel Reducing Tees - Seamless

Size	304L	316L
1"-½" SCH10S RED TEE	0.18	0.18
1½"-½" SCH10S RED TEE		0.65
1½"-¾" SCH10S RED TEE		0.14
1½"-1" SCH40S RED TEE		0.52
2"-1" SCH10S RED TEE		0.56
2"-1" SCH40S RED TEE		0.77
3"-2" SCH10S RED TEE		1.24
4"-2" SCH10S RED TEE	1.96	

Stainless Steel Long Radius Elbows - 90 Degree - Seamless



Size	304L	316L
½" SCH10S 90 LR ELBOW	0.06	0.06
½" SCH40S 90 LR ELBOW	0.08	0.08
½" SCH80S 90 LR ELBOW		0.10
¾" SCH10S 90 LR ELBOW	0.06	0.06
¾" SCH40S 90 LR ELBOW		0.08
¾" SCH80S 90 LR ELBOW		0.10
1" SCH10S 90 LR ELBOW	0.13	0.13
1" SCH40S 90 LR ELBOW	0.15	0.15
1" SCH80S 90 LR ELBOW		0.20
1½" SCH10S 90 LR ELBOW	0.28	0.28
1½" SCH40S 90 LR ELBOW	0.37	0.37
1½" SCH80S 90 LR ELBOW		0.49
2" SCH10S 90 LR ELBOW	0.48	0.48
2" SCH40S 90 LR ELBOW	0.66	0.66
2" SCH80S 90 LR ELBOW		0.91
2½" SCH10S 90 LR ELBOW	0.80	0.80
3" SCH10S 90 LR ELBOW	1.18	1.18
3" SCH40S 90 LR ELBOW	2.07	2.07
4" SCH10S 90 LR ELBOW	2.04	2.04
4" SCH40S 90 LR ELBOW	3.92	3.92
6" SCH10S 90 LR ELBOW	5.06	5.06
6" SCH40S 90 LR ELBOW		10.35
8" SCH10S 90 LR ELBOW	9.74	

Stainless Steel

Butt Weld Fittings



Stainless Steel Long Radius 45 Degree Elbows - Seamless

Size	304L	316L
½" SCH40S 45 LR ELBOW		0.04
1" SCH10S 45 LR ELBOW		0.06
1½" SCH10S 45 LR ELBOW		0.14
1½" SCH40S 45 LR ELBOW		0.18
2" SCH10S 45 LR ELBOW		0.24
2" SCH40S 45 LR ELBOW		0.33



Stainless Steel End Caps - Seamless

Size	304L	316L
½" SCH10S END CAP		0.03
1" SCH10S END CAP	0.07	0.07
1" SCH40S END CAP		0.10
1¼" SCH10S END CAP		0.10
1½" SCH10S END CAP	0.13	0.13
2" SCH10S END CAP	0.19	0.19
2½" SCH40S END CAP	0.37	
3" SCH10S END CAP	0.38	0.38
3" SCH40S END CAP		0.64
4" SCH10S END CAP	0.57	0.57
6" SCH10S END CAP		1.41
8" SCH40S END CAP		5.08
12" SCH10S END CAP		6.68



Stainless Steel Concentric Reducers - Seamless

Size	304L	316L
1"-½" SCH10S CON-RED		0.11
1"-½" SCH40S CON-RED		0.13
1½"-1" SCH10S CON-RED	0.20	0.20
1½"-1" SCH40S CON-RED		0.26
1½"-1¼" SCH40S CON-RED		0.26
2"-1" SCH10S CON-RED	0.30	0.30
2"-1" SCH40S CON-RED	0.42	0.42
2"-1½" SCH10S CON-RED		0.30
2"-1½" SCH40S CON-RED		0.42
3"-1½" SCH40S CON-RED		1.02
3"-2" SCH10S CON-RED		0.58
3"-2" SCH40S CON-RED		1.02
4"-2" SCH10S CON-RED	0.87	0.87
4"-2" SCH40S CON-RED		1.66
4"-3" SCH10S CON-RED	0.87	0.87
6"-3" SCH10S CON-RED		1.97
6"-4" SCH10S CON-RED		1.97

Stainless Steel Eccentric Reducers - Seamless

Size	304L	316L
1¼"-1" SCH10S ECC-RED		0.18
4"-3" SCH10S ECC-RED		0.87

Butt Weld Fittings



Stainless Steel Short Radius Elbows - 90 Degree - Seamless (ANSI B16.28)

Size	304L	316L
1½" SCH40S 90 SR ELBOW		0.25
2" SCH10S 90 SR ELBOW		0.32
2" SCH40S 90 SR ELBOW		0.44
3" SCH10S 90 SR ELBOW		0.79
3" SCH40S 90 SR ELBOW		1.38
4" SCH10S 90 SR ELBOW		1.36
4" SCH40S 90 SR ELBOW		2.60
6" SCH10S 90 SR ELBOW		5.45



Stainless Steel Stub Ends Type A MSS SP43 Seamless

Size	304L	316L
1" SCH10S STUB TYPE A		0.14
1½" SCH10S STUB TYPE A		0.25
2" SCH10S STUB TYPE A	0.38	0.38
3" SCH10S STUB TYPE A		0.64
4" SCH10S STUB TYPE A		0.98
6" SCH10S STUB TYPE A		1.95



Stainless Steel Equal Tees - Welded

Size	304L	316L
½" SCH10S EQUAL TEE	0.06	0.06
¾" SCH10S EQUAL TEE	0.08	0.08
1" SCH10S EQUAL TEE	0.18	0.18
1" SCH40S EQUAL TEE	0.21	0.21
1½" SCH10S EQUAL TEE	0.40	0.40
1½" SCH40S EQUAL TEE	0.52	0.52
2" SCH10S EQUAL TEE	0.56	0.56
2" SCH40S EQUAL TEE	0.77	0.77
3" SCH10S EQUAL TEE	1.24	1.24
4" SCH10S EQUAL TEE	1.96	1.96
6" SCH10S EQUAL TEE		4.43

Stainless Steel Reducing Tees - Welded

Size	304L	316L
1"-½" SCH10S RED TEE		0.18
1½"-1" SCH10S RED TEE	0.40	0.40
2"-1" SCH10S RED TEE	0.56	0.56
2"-1½" SCH10S RED TEE	0.56	
3"-1½" SCH10S RED TEE	1.24	
3"-2" SCH10S RED TEE	1.24	1.24

Butt Weld Fittings



Stainless Steel Long Radius 90 Degree Elbows - Welded

Size	304L	316L
½" SCH10S 90 LR ELBOW	0.06	0.06
½" SCH40S 90 LR ELBOW	0.08	0.08
¾" SCH10S 90 LR ELBOW	0.06	0.06
¾" SCH40S 90 LR ELBOW	0.08	0.08
1" SCH10S 90 LR ELBOW	0.13	0.13
1" SCH40S 90 LR ELBOW	0.15	0.15
1¼" SCH10S 90 LR ELBOW	0.21	0.21
1¼" SCH40S 90 LR ELBOW	0.26	
1½" SCH10S 90 LR ELBOW	0.28	0.28
1½" SCH40S 90 LR ELBOW		0.37
2" SCH10S 90 LR ELBOW	0.48	0.48
2" SCH40S 90 LR ELBOW	0.66	0.66
2½" SCH10S 90 LR ELBOW	0.80	0.80
3" SCH10S 90 LR ELBOW	1.18	1.18
3" SCH40S 90 LR ELBOW	2.07	2.07
4" SCH10S 90 LR ELBOW	2.04	2.04
4" SCH40S 90 LR ELBOW	3.92	3.92
6" SCH10S 90 LR ELBOW	5.06	5.06
6" SCH40S 90 LR ELBOW	10.35	10.35
8" SCH10S 90 LR ELBOW	9.74	9.74
8" SCH40S 90 LR ELBOW		20.76
10" SCH10S 90 LR ELBOW	16.95	16.95
12" SCH10S 90 LR ELBOW	26.35	26.35
12" SCH40S 90 LR ELBOW		54.04
14" SCH10S 90 LR ELBOW		35.28
16" SCH10S 90 LR ELBOW		46.10
20" SCH10S 90 LR ELBOW		83.70

Stainless Steel Long Radius 45 Degree Elbows - Welded

Size	304L	316L
¾" SCH40S 45 LR ELBOW	0.03	0.04
1" SCH10S 45 LR ELBOW		0.06
1" SCH40S 45 LR ELBOW		0.08
1½" SCH10S 45 LR ELBOW	0.14	0.14
1½" SCH40S 45 LR ELBOW		0.18
2" SCH10S 45 LR ELBOW	0.24	0.24
3" SCH10S 45 LR ELBOW	0.59	0.59
4" SCH10S 45 LR ELBOW	1.02	1.02
6" SCH10S 45 LR ELBOW	2.53	2.53
8" SCH10S 45 LR ELBOW		4.87
10" SCH10S 45 LR ELBOW		8.47

Stainless Steel

Butt Weld Fittings



Stainless Steel Concentric Reducers - Welded

Size	304L	316L
1"-½" SCH10S CON-RED	0.11	0.11
1"-½" SCH40S CON-RED		0.13
1"-¾" SCH10S CON-RED	0.11	
1½"-1" SCH10S CON-RED	0.20	0.20
1½"-1" SCH40S CON-RED		0.26
2"-1" SCH10S CON-RED	0.30	0.30
2"-1½" SCH10S CON-RED	0.30	0.30
2"-1½" SCH40S CON-RED	0.42	0.42
2½"-2" SCH10S CON-RED		0.48
3"-1½" SCH10S CON-RED	0.58	0.58
3"-2" SCH10S CON-RED	0.58	0.58
3"-2" SCH40S CON-RED		1.02
3"-2½" SCH10S CON-RED		0.58
4"-2" SCH10S CON-RED	0.87	0.87
4"-3" SCH10S CON-RED	0.87	0.87
6"-3" SCH10S CON-RED	1.97	
6"-4" SCH10S CON-RED	1.97	1.97
8"-4" SCH10S CON-RED		3.10
8"-6" SCH10S CON-RED		3.10

Stainless Steel Eccentric Reducers - Welded

Size	304L	316L
1½"-1" SCH10S ECC-RED		0.20
1½"-1" SCH40S ECC-RED		0.26
2½"-2" SCH10S ECC-RED		0.48
3"-1½" SCH10S ECC-RED		0.58
3"-2" SCH10S ECC-RED	0.58	
4"-2" SCH10S ECC-RED		0.87
4"-3" SCH10S ECC-RED		0.87



Stainless Steel Stub Ends Type A MSS SP43 Welded

Size	304L	316L
½" SCH10S STUB TYPE A		0.08
1" SCH10S STUB TYPE A	0.14	0.14
1½" SCH10S STUB TYPE A	0.25	0.25
2" SCH10S STUB TYPE A	0.38	0.38
2½" SCH10S STUB TYPE A		0.47
3" SCH10S STUB TYPE A		0.64
4" SCH10S STUB TYPE A		0.98
6" SCH10S STUB TYPE A		1.95
8" SCH10S STUB TYPE A		3.11

Flanges



Stainless Steel Raised Face Blind Flanges ASTM A182/ANSI B16.5 150lb Grades 304L & 316L

Size	KG/Unit
½" 150lb RF BLIND	0.42
¾" 150lb RF BLIND	0.61
1" 150lb RF BLIND	0.86
1½" 150lb RF BLIND	1.53
2" 150lb RF BLIND	2.42
2½" 150lb RF BLIND	3.94
3" 150lb RF BLIND	4.93
4" 150lb RF BLIND	7.00
6" 150lb RF BLIND	11.3
8" 150lb RF BLIND	19.6
10" 150lb RF BLIND	28.8
12" 150lb RF BLIND	43.2

Flanges



Stainless Steel Raised Face Blind Flanges ASTM A182/ANSI B16.5 300lb Grade 316

Size	KG/Unit
¾" 300lb RF BLIND	1.11
1" 300lb RF BLIND	1.39
2" 300lb RF BLIND	3.18
3" 300lb RF BLIND	6.81
4" 300lb RF BLIND	11.50

Stainless Steel Raised Face Slip On Flanges ASTM A182/ANSI B16.5 150lb Grades 304L & 316L

Size	KG/Unit
½" 150lb RF SLIP ON	0.39
¾" 150lb RF SLIP ON	0.56
1" 150lb RF SLIP ON	0.78
1¼" 150lb RF SLIP ON	1.03
1½" 150lb RF SLIP ON	1.32
2" 150lb RF SLIP ON	2.06
2½" 150lb RF SLIP ON	3.28
3" 150lb RF SLIP ON	3.85
4" 150lb RF SLIP ON	5.30
5" 150lb RF SLIP ON	6.01
6" 150lb RF SLIP ON	7.45
8" 150lb RF SLIP ON	12.1
10" 150lb RF SLIP ON	16.5
12" 150lb RF SLIP ON	26.2
14" 150lb RF SLIP ON	34.6
16" 150lb RF SLIP ON	44.8

Stainless Steel Raised Face Slip On Flanges ASTM A182/ANSI B16.5 300lb Grade 316

Size	KG/Unit
1" 300lb RF SLIP ON	1.36
1½" 300lb RF SLIP ON	2.49
2" 300lb RF SLIP ON	2.87
3" 300lb RF SLIP ON	5.85
4" 300lb RF SLIP ON	9.61

Stainless Steel Raised Face Weld Neck Flanges ASTM A182/ANSI B16.5 150lb Grades 304L & 316L

Size	KG/Unit
½" 150lb RFWN SCH10S	0.48
½" 150lb RFWN SCH40S	0.48
¾" 150lb RFWN SCH40S	0.71
1" 150lb RFWN SCH10S	1.01
1" 150lb RFWN SCH40S	1.01
1½" 150lb RFWN SCH10S	1.72
1½" 150lb RFWN SCH40S	1.72
2" 150lb RFWN SCH10S	2.58
2" 150lb RFWN SCH40S	2.58
2½" 150lb RFWN SCH10S	4.11
2½" 150lb RFWN SCH40S	4.11
3" 150lb RFWN SCH10S	4.92
3" 150lb RFWN SCH40S	4.92
4" 150lb RFWN SCH10S	6.84
4" 150lb RFWN SCH40S	6.84
6" 150lb RFWN SCH10S	10.6
6" 150lb RFWN SCH40S	10.6
8" 150lb RFWN SCH10S	17.6
10" 150lb RFWN SCH10S	24.0
12" 150lb RFWN SCH10S	24.0

Flanges



Stainless Steel Raised Face Weld Neck Flanges ASTM A182/ANSI B16.5 300lb Grade 316

Size	KG/Unit
¾" 300lb RFWN SCH40S	1.26
1" 300lb RFWN SCH10S	1.52
1" 300lb RFWN SCH40S	1.52
2" 300lb RFWN SCH10S	3.40
2" 300lb RFWN SCH40S	3.40
3" 300lb RFWN SCH10S	4.92
3" 300lb RFWN SCH40S	6.93
4" 300lb RFWN SCH40S	11.20

Stainless Steel Plate Flanges BS10 Table E - Blind Grade 316L

Size	KG/Unit
1" NB TABLE E BLIND	0.52
1½" TABLE E BLIND	0.88
2" TABLE E BLIND	1.26
3" TABLE E BLIND	2.23
4" TABLE E BLIND	3.45
6" TABLE E BLIND	5.14

Stainless Steel Plate Flanges BS10 Table E - Slip On Grade 316L

Size	KG/Unit
½" TABLE E SLIP ON	0.30
¾" TABLE E SLIP ON	0.33
1" TABLE E SLIP ON	0.47
1½" TABLE E SLIP ON	0.75
2" TABLE E SLIP ON	1.03
3" TABLE E SLIP ON	1.65
4" TABLE E SLIP ON	2.40
6" TABLE E SLIP ON	5.14
8" TABLE E SLIP ON	7.50

Stainless Steel BS4504/BSEN 1092 Flanges PN16/105 Raised Face Blind Grades 304L & 316L

Size	KG/Unit
1" PN 16/105 RF BLIND	1.30
1½" PN 16/105 RF BLIND	2.30
2" PN 16/105 RF BLIND	3.00
3" PN 16/105 RF BLIND	5.10
4" PN 16/105 RF BLIND	6.00
6" PN 16/105 RF BLIND	11.10

Stainless Steel BS4504/BSEN 1092 Flanges PN16/101 Raised Face Slip On Grades 304L & 316L

Size	KG/Unit
½" PN 16/101 RF S.O.	0.75
¾" PN 16/101 RF S.O.	0.90
1" PN 16/101 RF S.O.	1.10
1¼" PN 16/101 RF S.O.	1.70
1½" PN 16/101 RF S.O.	2.00
2" PN 16/101 RF S.O.	2.60
2½" PN 16/101 RF S.O.	3.20
3" PN 16/101 RF S.O.	4.10
4" PN 16/101 RF S.O.	4.40
6" PN 16/101 RF S.O.	7.20
8" PN 16/101 RF S.O.	9.90
10" PN 16/101 RF S.O.	14.30

Stainless Steel

High Pressure Fittings - Threaded

High Pressure 3000lb NPT Threaded Fittings to ANSI B16.11 in Grades 304L & 316L

Size Range: 1/2" to 3"



90° Elbow



45° Elbow



Equal Tee



Reducing Tee



Hexagon Plug



Cap



Full Coupling



Half Coupling



Union



Hexagon Nipple

For further information please see the full brochure on this range which can be downloaded from the Aalco web site at www.aalco.co.uk or requested from your local Service Centre

Stainless Steel

High Pressure Fittings - Socket Weld

High Pressure 3000lb Socket Weld Fittings to ANSI B16.11 in Grades 304L & 316L

Size Range: 1/2" to 3"



90° Elbow



45° Elbow



Equal Tee



Reducing Tee



Full Coupling



Union



Cap

For further information please see the full brochure on this range which can be downloaded from the Aalco web site at www.aalco.co.uk or requested from your local Service Centre

Stainless Steel

Seamless Tube



Seamless Stainless Steel Tube ASTM A269/A213 Grade 316

Size	KG/Metre
1/8" OD X 0.022" (24swg)	0.04
1/8" OD X 0.028" (22swg)	0.04
1/8" OD X 0.036" (20swg)	0.05
3/16" OD X 0.022" (24swg)	0.06
3/16" OD X 0.028" (22swg)	0.07
3/16" OD X 0.036" (20swg)	0.09
1/4" OD X 0.048" (18swg)	0.11
1/4" OD X 0.028" (22swg)	0.10
1/4" OD X 0.036" (20swg)	0.12
1/4" OD X 0.048" (18swg)	0.16
1/4" OD X 0.064" (16swg)	0.19
5/16" OD X 0.028" (22swg)	0.13
5/16" OD X 0.036" (20swg)	0.16
5/16" OD X 0.064" (16swg)	0.26
3/8" OD X 0.028" (22swg)	0.16
3/8" OD X 0.036" (20swg)	0.20
3/8" OD X 0.048" (18swg)	0.25
3/8" OD X 0.064" (16swg)	0.32
3/8" OD X 0.080" (14swg)	0.38
1/2" OD X 0.028" (22swg)	0.21
1/2" OD X 0.036" (20swg)	0.26
1/2" OD X 0.048" (18swg)	0.35
1/2" OD X 0.064" (16swg)	0.45
1/2" OD X 0.080" (14swg)	0.54
1/2" OD X 0.125"	0.76
5/8" OD X 0.036" (20swg)	0.34
5/8" OD X 0.048" (18swg)	0.45
5/8" OD X 0.064" (16swg)	0.58
5/8" OD X 0.080" (14swg)	0.70
5/8" OD X 0.125"	1.01
3/4" OD X 0.036" (20swg)	0.41
3/4" OD X 0.048" (18swg)	0.54
3/4" OD X 0.064" (16swg)	0.71
3/4" OD X 0.080" (14swg)	0.86
3/4" OD X 0.104" (12swg)	1.08
3/4" OD X 0.128" (10swg)	1.26
7/8" OD X 0.064" (16swg)	0.84
1" OD X 0.036" (20swg)	0.56
1" OD X 0.048" (18swg)	0.74
1" OD X 0.064" (16swg)	0.97
1" OD X 0.080" (14swg)	1.19
1" OD X 0.104" (12swg)	1.50
1" OD X 0.128" (10swg)	1.77
1 1/4" OD X 0.064" (16swg)	1.20
1 1/4" OD X 0.080" (14swg)	1.50
1 1/4" OD X 0.125"	2.30
1 1/2" OD X 0.064" (16swg)	1.50
1 1/2" OD X 0.125"	2.80
2" OD X 0.125"	3.79
2" OD X 0.250"	7.06
2 1/2" OD X 0.25"	9.10
3" OD X 0.064" (16swg)	3.00
3" OD X 0.128" (10swg)	5.90
3" OD X 0.250"	11.09

Seamless Stainless Steel Tube ASTM A269/A213 Grade 304

Size	KG/Metre
6.0mm OD X 1.0mm	0.12
10.0mm OD X 1.0mm	0.22
12.0mm OD X 1.0mm	0.30
15.0mm OD X 1.5mm	0.50

Seamless Tube



Seamless Stainless Steel Tube ASTM A269/A213 Grade 316

Size	KG/Metre
6.0mm OD X 0.50mm	0.07
6.0mm OD X 1.0mm	0.13
6.0mm OD X 1.5mm	0.17
8.0mm OD X 1.0mm	0.18
8.0mm OD X 1.5mm	0.24
10.0mm OD X 1.0mm	0.23
10.0mm OD X 1.5mm	0.32
10.0mm OD X 2.0mm	0.40
12.0mm OD X 1.0mm	0.30
12.0mm OD X 1.5mm	0.39
12.0mm OD X 2.0mm	0.50
15.0mm OD X 1.5mm	0.50
16.0mm OD X 1.5mm	0.54
16.0mm OD X 2.0mm	0.70
18.0mm OD X 1.5mm	0.61
20.0mm OD X 1.5mm	0.69
20.0mm OD X 2.0mm	0.90
22.0mm OD X 1.5mm	0.77
25.0mm OD X 1.5mm	0.90
25.0mm OD X 2.0mm	1.20
25.0mm OD X 2.5mm	1.40
25.0mm OD X 3.0mm	1.70

Seamless Stainless Steel Tube ASTM A269/A213 Grade 304

Size	KG/Metre
1/4" OD X 0.036" (20swg)	0.12
5/8" OD X 0.036" (20swg)	0.34
1/2" OD X 0.048" (18swg)	0.35
3/4" OD X 0.036" (20swg)	0.41
5/8" OD X 0.048" (18swg)	0.44
5/8" OD X 0.064" (16swg)	0.58
3/4" OD X 0.064" (16swg)	0.70
1" OD X 0.048" (18swg)	0.73

Metric Tube and Fittings

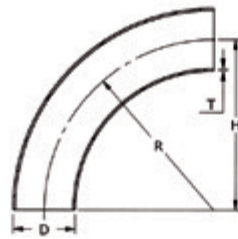

Welded 45° & 90° elbows (radius D+100)

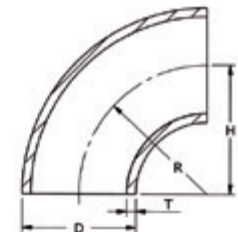

Welded 45° & 90° elbows (radius 1.5D)

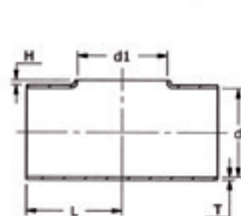

Pulled equal and reducing tees

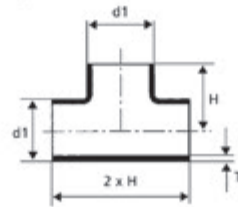

Equal tees with branch

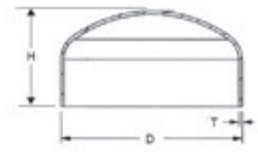

Pressed end caps

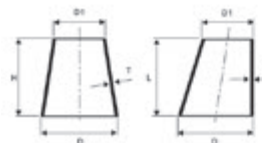

Concentric and eccentric reducers



Pressed collars

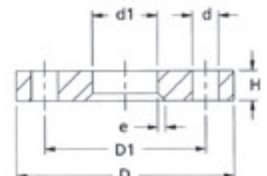

Flanges

Metric Tube and Fittings



Stainless Steel Metric Welded Tube EN10217-7-2006 TC1 Grades 304L & 316L

Size	KG/Metre
28mm O/D X 1.5MM WALL	0.99
38MM O/D X 1.5MM WALL	1.37
43MM O/D X 1.5MM WALL	1.56
44.5MM O/D X 2.0MM WALL	2.13
53MM O/D X 1.5MM WALL	1.93
54MM O/D X 2.0MM WALL	2.40
83MM O/D X 1.5MM WALL	3.06
84MM O/D X 2.0MM WALL	3.90
103MM O/D X 1.5MM WALL	3.81
104MM O/D X 2.0MM WALL	5.12
129 MM O/D 2.0MM WALL	6.35
153MM O/D X 1.5MM WALL	5.68
154MM O/D X 2.0MM WALL	7.60
204MM O/D X 2.0MM WALL	10.1
254MM O/D X 2.0MM WALL	15.8
304MM O/D X 2.0MM WALL	15.1

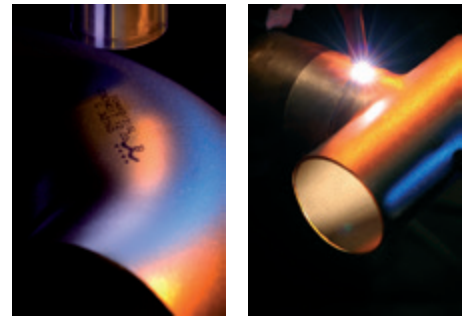

Stainless Steel

BSP Fittings

Sizes: 1/8", 1/4", 3/8", 1/2", 3/4", 1", 1 1/2", 2", 3"

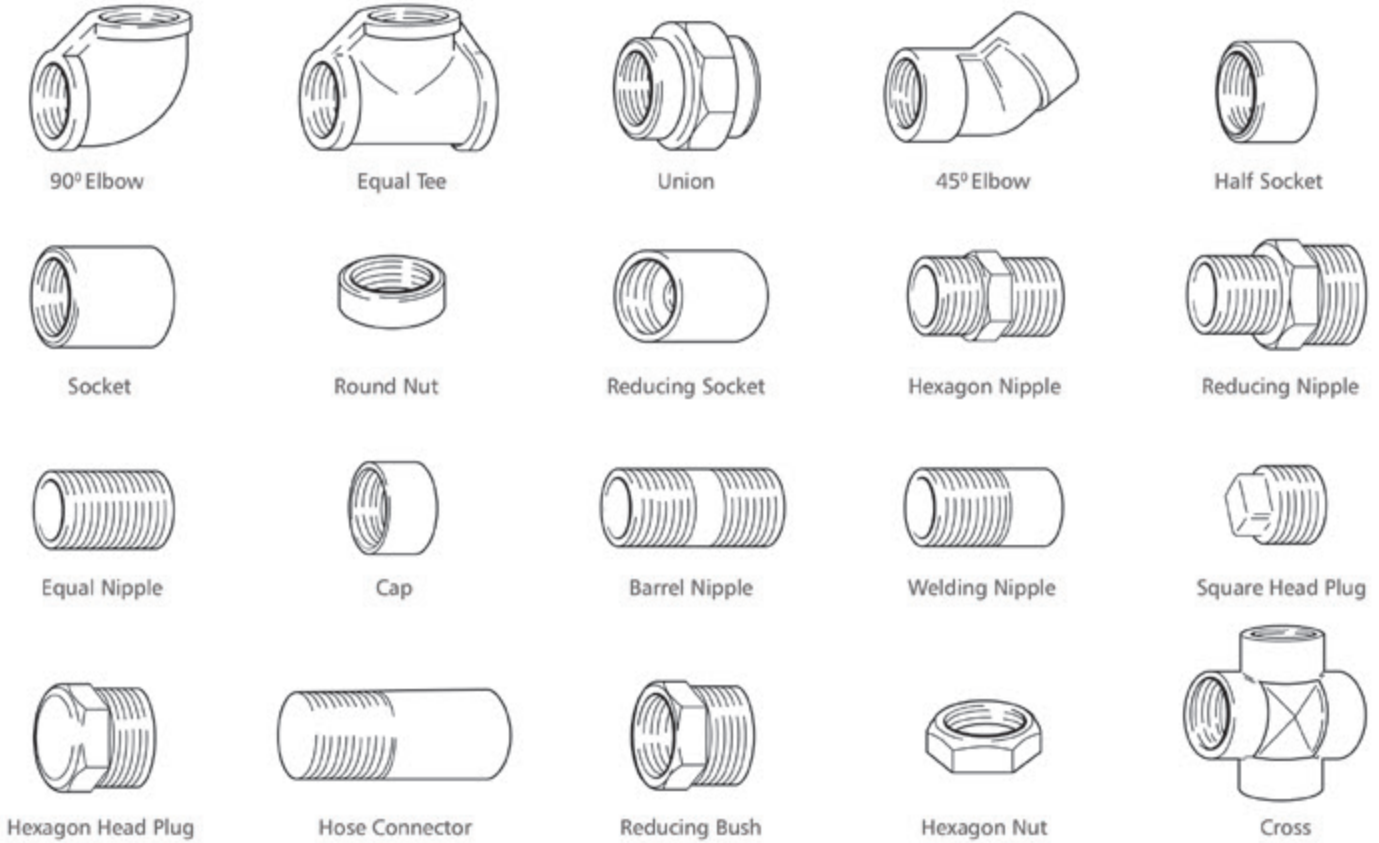

Hygienic Tube and Fittings

Stainless Steel Hygienic Tube to ASTM A270 Grades 304L & 316L. Available in Bright Annealed or with Satin Polished O/D

Size	KG/Metre
3/4" O/D X 16SWG	0.72
1" O/D X 16SWG	0.97
1 1/2" O/D X 16SWG	1.45
2" O/D X 16SWG	1.99
2 1/2" O/D X 16SWG	2.51
3" O/D X 16SWG	3.02
4" O/D X 16SWG	4.04
4" O/D X 14SWG	5.02

Stainless Steel Hygienic Tube to DIN 11850 - UN-ANNEALED - Grade 316L. Available Descaled or with Satin Polished O/D

Size	KG/Metre
1" OD X 1.5mm	0.9
1 1/2" OD X 1.5mm	1.37
2" OD X 1.5mm	1.85
2 1/2" OD X 1.5mm	2.33
3" OD X 1.5mm	2.8
4" OD X 1.5mm	3.75
4" OD X 2.0mm	4.98
4" O/D X 14SWG	5.02

Stainless Steel Hygienic Tube to DIN 11850 - UN-ANNEALED - Grade 304. Available Descaled or with Satin Polished O/D

Size	KG/Metre
1" OD X 1.5mm	0.9
1 1/2" OD X 1.5mm	1.37
2" OD X 1.5mm	1.85





Brass Products

Sheet.....	32
Rod	32
Hexagon Bar.....	33
Flat Bar.....	33
Plate.....	33
Tube	33
Square Bar.....	33
Equal Angle.....	33

Copper Products

Sheet.....	34
Flat Bar.....	34
Rod	34
Round Tube.....	34

Bronze Products

Rod	35
-----------	----



Metals Main Index

Aluminium	04
Stainless Steel	15
Brass	32
Copper	34
Bronze	35

Brass Sheet



Brass Sheet Alloy CW508L/CZ108 - In Half Hard Condition

Size	KG/Sheet
4' X 2' X 0.55mm	3.45
4' X 2' X 0.90mm	5.65
4' X 2' X 18SWG	7.66
4' X 2' X 16SWG	10.24
4' X 2' X 2.0mm	12.6
4' X 2' X 12SWG	16.7
4' X 2' X 10SWG	20.4
8' X 1000mm X 0.9mm	18.5
8' X 1000mm X 1.2mm	24.7
8' X 1000mm X 1.5mm	30.9
8' X 4' X 18SWG	30.6
8' X 4' X 1.6mm	40.2
8' X 4' X 14SWG	51.0
8' X 4' X 10SWG	81.6
2000mm X 1000mm X 0.45mm	7.61
2000mm X 1000mm X 0.55mm	9.30
2000mm X 1000mm X 0.7mm	11.83
2000mm X 1000mm X 0.9mm	15.21
2000mm X 1000mm X 1.2mm	20.28
2000mm X 1000mm X 1.5mm	25.35
2000mm X 1000mm X 2.0mm	33.80
2000mm X 1000mm X 2.5mm	42.25
2000mm X 1000mm X 3.0mm	50.70

Brass Sheet Alloy CW505L/CZ106 - In Soft (O) Condition

Size	KG/Sheet
4' X 2' X 24SWG	3.51
4' X 2' X 20SWG	5.70
4' X 2' X 18SWG	7.64
2000mm X 1000mm X 0.55mm	9.27
2000mm X 1000mm X 0.7mm	11.80
2000mm X 1000mm X 0.9mm	15.17
2000mm X 1000mm X 1.2mm	20.23
2000mm X 1000mm X 1.6mm	26.98
2000mm X 1000mm X 2.0mm	33.72

Polished Brass Sheet Alloy CW508L/CZ108 - In Half Hard Condition

Size	KG/Sheet
2000mm X 1000mm X 0.55mm	9.43
2000mm X 1000mm X 0.7mm	12.0
2000mm X 1000mm X 0.9mm	15.4
2000mm X 1000mm X 1.2mm	20.6
2000mm X 1000mm X 1.5mm	25.7
2000mm X 1000mm X 2.0mm	34.3
2000mm X 1000mm X 2.5mm	42.9
2000mm X 1000mm X 3.0mm	51.5
8' X 1000mm X 1.2mm	25.1
8' X 1000mm X 1.5mm	31.4

Rod



Brass Rod Alloy CW614N/CZ121 - Free Machining Brass

Size	KG/Metre
1/8" DIA	0.07
1/4" DIA	0.11
4.0mm DIA	0.11
3/16" DIA	0.15
5.0mm DIA	0.17
7/32" DIA	0.21
6.0mm DIA	0.24
1/4" DIA	0.27
7.0mm DIA	0.33
9/32" DIA	0.34
5/16" DIA	0.42
8.0mm DIA	0.43
11/32" DIA	0.51
9.0mm DIA	0.54
3/8" DIA	0.61
10.0mm DIA	0.67
7/16" DIA	0.82
12.0mm DIA	0.96
1/2" DIA	1.08
13.0mm DIA	1.13
17/32" DIA	1.21
14.0mm DIA	1.31
9/16" DIA	1.36
15.0mm DIA	1.50
5/8" DIA	1.68
16.0mm DIA	1.71
17.0mm DIA	1.93
11/16" DIA	2.04
18.0mm DIA	2.16
3/4" DIA	2.42
20.0mm DIA	2.67
13/16" DIA	2.84
22.0mm DIA	3.23
7/8" DIA	3.30
15/16" DIA	3.78
24.0mm DIA	3.85
25.0mm DIA	4.17
1" DIA	4.31
26.0mm DIA	4.51
1 1/16" DIA	4.86
28.0mm DIA	5.23
1 1/8" DIA	5.45
30.0mm DIA	6.01
1 3/16" DIA	6.07
1 1/4" DIA	6.73
1 1/8" DIA	7.42
1 3/8" DIA	8.15
35.0mm DIA	8.18
1 1/2" DIA	9.69
40.0mm DIA	10.7
1 5/8" DIA	11.4
1 3/4" DIA	13.2
1 7/8" DIA	15.1
50.0mm DIA	16.7
2" DIA	17.2
2 1/8" DIA	19.4
2 1/4" DIA	21.8
60.0mm DIA	24.0
2 3/8" DIA	24.3
2 1/2" DIA	26.9
65.0mm DIA	28.2
2 5/8" DIA	29.7
2 3/4" DIA	32.6
3" DIA	38.8

Rod



Brass Rod Alloy CW614N/CZ121 - Free Machining Brass (continued)

Size	KG/Metre
3/4" DIA	45.5
3 1/2" DIA	52.8
3 3/4" DIA	60.6
4" DIA	68.9
4 1/4" DIA	77.8
4 1/2" DIA	87.2
130mm DIA	113
155mm DIA	160
180mm DIA	216
205mm DIA	281

Brass Rod Alloy CW721R / CZ114 - High Tensile Brass / Manganese Bronze

Size	KG/Metre
3/8" DIA	0.59
1/2" DIA	1.04
5/8" DIA	1.63
3/4" DIA	2.34
13/16" DIA	2.75
7/8" DIA	3.19
1" DIA	4.16
1 1/4" DIA	6.51
1 3/8" DIA	7.87
1 1/2" DIA	9.37
1 3/4" DIA	12.8
2" DIA	16.7
2 1/4" DIA	21.1
2 1/2" DIA	26.0
2 3/4" DIA	31.5
3" DIA	37.5
4" DIA	66.6

Brass Rod Alloy CW606N/CZ131 - Riveting Quality Brass

Size	KG/Metre
1/4" DIA	0.27
3/16" DIA	0.42
3/8" DIA	0.61
7/16" DIA	0.82
1/2" DIA	1.08
5/8" DIA	1.68
3/4" DIA	2.42

Brass Rod Alloy CW712R/CZ112 - Naval Brass

Size	KG/Metre
3/4" DIA	2.41
1" DIA	4.28
1 1/4" DIA	6.69
1 1/2" DIA	9.63
1 3/4" DIA	13.1
2" DIA	17.1
2 1/2" DIA	26.8
3" DIA	38.5

Brass

Hexagon Bar

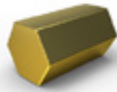

Brass Hexagon Bar Alloy CW614N/CZ121

Size	KG/Metre
5.0mm A/F	0.18
6.0mm A/F	0.27
0.248" A/F	0.29
¼" A/F	0.30
⅜" A/F	0.46
8.0mm A/F	0.47
0.324" A/F	0.50
⅝" A/F	0.67
10.0mm A/F	0.74
11.0mm A/F	0.89
⅞" A/F	0.91
0.445" A/F	0.94
12.0mm A/F	1.06
½" A/F	1.19
13.0mm A/F	1.24
0.525" A/F	1.31
14.0mm A/F	1.44
⅝" A/F	1.50
15.0mm A/F	1.66
.600" A/F	1.71
⅞" A/F	1.71
16.0mm A/F	1.88
17.0mm A/F	2.13
⅞" A/F	2.24
18.0mm A/F	2.39
0.710" A/F	2.39
19.0mm A/F	2.66
¾" A/F	2.67
20.0mm A/F	2.94
1⅜" A/F	3.14
0.820" A/F	3.19
22.0mm A/F	3.56
⅞" A/F	3.64
0.920" A/F	4.02
1⅝" A/F	4.17
24.0mm A/F	4.24
1" A/F	4.75
1.010" A/F	4.84
1⅞" A/F	5.36
1.100" A/F	5.75
1⅞" A/F	6.01
30.0mm A/F	6.63
1.200" A/F	6.84
1¼" A/F	7.42
32.0mm A/F	7.54
1.300" A/F	8.03
1⅝" A/F	8.18
1⅞" A/F	8.98
36.0mm A/F	9.54
1.480" A/F	10.40
1½" A/F	10.69
41.0mm A/F	12.37
1.625" A/F	12.54
1.670" A/F	13.25
46.0mm A/F	15.58
1.860" A/F	16.43
50.0mm A/F	18.40
2.050" A/F	19.96
2.200" A/F	22.99
60.0mm A/F	26.50
2½" A/F	29.68
65.0mm A/F	31.10
2¾" A/F	35.92
3" A/F	42.74

continued...

Flat Bar

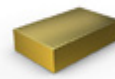

Brass Flat Bar CW614N/CZ121

Size	KG/Metre
⅜" X ⅛"	0.26
⅜" X ¼"	0.51
½" X ⅛"	0.34
⅝" X ⅛"	0.43
⅝" X ¼"	0.86
⅝" X ⅜"	1.29
½" X ¼"	0.69
¾" X ⅛"	0.51
¾" X ⅜"	0.77
¾" X ¼"	1.03
¾" X ⅝"	1.54
¾" X ½"	2.06
1" X ⅛"	0.69
1" X ⅜"	1.03
1" X ¼"	1.37
1" X ⅝"	1.71
1" X ⅜"	2.06
1" X ½"	2.74
1" X ⅝"	3.43
1" X ¾"	4.11
1¼" X ⅛"	0.86
1¼" X ¼"	1.71
1¼" X ⅜"	2.57
1¼" X ½"	3.43
1¼" X ¾"	5.14
1¼" X 1"	6.85
1½" X ⅛"	1.03
1½" X ⅜"	1.54
1½" X ¼"	2.06
1½" X ⅝"	3.09
1½" X ½"	4.11
1½" X ⅞"	5.14
1½" X ¾"	6.17
1½" X 1"	8.23
1¾" X 1/2"	4.80
2" X ⅛"	1.37
2" X ⅜"	2.05
2" X ¼"	2.74
2" X ⅝"	4.12
2" X ½"	5.48
2" X ⅞"	6.86
2" X ¾"	8.23
2" X 1"	10.97
2" X 1¼"	13.71
2" X 1½"	16.45
2½" X ¼"	3.43
2½" X ⅜"	5.14
2½" X ½"	6.85
2½" X ¾"	10.28
2½" X 1"	13.71
2½" X 1¼"	17.14
2½" X 1½"	20.56
3" X ⅛"	2.06
3" X ¼"	4.11
3" X ⅜"	6.17
3" X ½"	8.23
3" X 1"	16.45
3" X 1½"	24.68
3" X 2"	32.90
4" X ⅛"	2.75
4" X ¼"	5.48
4" X ½"	10.97
4" X ¾"	16.45
4" X 1½"	32.90

Plate



Brass Plate Alloy CW508L/CZ108 Half Hard

Size	KG/Plate
2000mm X 1000mm X 4.0mm	69
2000mm X 1000mm X 4.76mm	82
2000mm X 1000mm X 5.0mm	86
2000mm X 1000mm X 6.35mm	109

Tube



Brass Tube for Handrail/Bar-rail Alloy CW508L/CZ108

Size	KG/Metre
2" O/D X 16SWG	2.13

Square Bar



Brass Square Bar Alloy CW614N/CZ121

Size	KG/Metre
¼" SQ	0.34
⅜" SQ	0.54
⅝" SQ	0.77
⅞" SQ	1.05
½" SQ	1.37
⅝" SQ	2.14
¾" SQ	3.08
⅞" SQ	4.20
1" SQ	5.48
1¼" SQ	8.57
1½" SQ	12.3
1¾" SQ	16.8
2" SQ	21.9
2¼" SQ	27.8
2½" SQ	34.3
3" SQ	49.4

Equal Angle

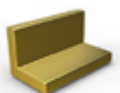

Brass Angle Alloy CW624N/CZ130

Size	KG/Metre
½" X ½" X ⅛"	0.62
¾" X ¾" X ⅛"	0.97
1" X 1" X ⅛"	1.33
1¼" X 1¼" X ⅛"	1.68
1½" X 1½" X ⅛"	2.03
1½" X 1½" X ⅜"	2.98
2" X 2" X ⅛"	2.74
2" X 2" X ¼"	5.30
3" X 3" X ¼"	8.12

Copper Sheet



Copper Sheet Alloy CW024A/C106 Half Hard

Size	KG/Sheet
4' X 2' X 24SWG	3.70
4' X 2' X 22SWG	4.70
4' X 2' X 20SWG	6.02
4' X 2' X 18SWG	8.07
4' X 2' X 16SWG	10.8
4' X 2' X 14SWG	13.4
4' X 2' X 10SWG	21.5
8' X 4' X 18SWG	32.3
8' X 4' X 1.6mm	42.3
8' X 4' X 2.0mm	52.9
8' X 4' X 3.0mm	79.4
8' X 4' X 4.0mm	105.8
2000mm X 1000mm X 0.55mm	9.8
2000mm X 1000mm X 0.7mm	12.5
2000mm X 1000mm X 0.9mm	16.0
2000mm X 1000mm X 1.2mm	21.4
2000mm X 1000mm X 1.5mm	26.7
2000mm X 1000mm X 2.0mm	35.6
2000mm X 1000mm X 2.5mm	44.5
2000mm X 1000mm X 3.0mm	53.4
2000mm X 1000mm X 4.0mm	74.0
2000mm X 1000mm X 5.0mm	92.6
2000mm X 1000mm X 6.0mm	111

Copper Sheet Alloy CW004A/C101 Half Hard

Size	KG/Sheet
4' X 2' X 20SWG	6.02
4' X 2' X 10SWG	21.5
1200mm X 600mm X 1.6mm	10.3
1200mm X 600mm X 2.0mm	12.8
2000mm X 1000mm X 0.9mm	16.0
2000mm X 1000mm X 1.2mm	21.4
2000mm X 1000mm X 1.5mm	26.7
2000mm X 1000mm X 2.0mm	35.6
2000mm X 1000mm X 3.0mm	53.4
2000mm X 1000mm X 4.0mm	74.0
2000mm X 1000mm X 5.0mm	92.6
2000mm X 1000mm X 6.0mm	111

Copper Sheet Alloy CW024A/C106 - Soft - Spinning Quality

Size	KG/Sheet
4' X 2' X 24SWG	3.70
4' X 2' X 20SWG	6.02
4' X 2' X 18SWG	8.07
2000mm X 1000mm X 0.55mm	9.8
2000mm X 1000mm X 0.7mm	12.5
2000mm X 1000mm X 0.9mm	16.0
2000mm X 1000mm X 1.2mm	21.4
2000mm X 1000mm X 1.5mm	26.7

Flat Bar



Copper Flat Bar - Radius Edge - Alloy CW004A/C101

Size	KG/Metre
1/2" X 1/8" Rad Edge	0.36
1/2" X 3/16" Rad Edge	0.54
5/8" X 1/8" Rad Edge	0.45
1/2" X 1/4" Rad Edge	0.72
3/4" X 1/8" Rad Edge	0.54
3/4" X 3/16" Rad Edge	0.81
3/4" X 1/4" Rad Edge	1.08
1" X 1/8" Rad Edge	0.72
1" X 3/16" Rad Edge	1.07
1" X 1/4" Rad Edge	1.44
1" X 1/2" Rad Edge	2.87
1 1/4" X 1/8" Rad Edge	0.90
1 1/4" X 3/16" Rad Edge	1.35
1 1/4" X 1/4" Rad Edge	1.79
1 1/2" X 1/8" Rad Edge	1.08
1 1/2" X 3/16" Rad Edge	1.61
1 1/2" X 1/4" Rad Edge	2.15
1 1/2" X 3/8" Rad Edge	3.23
2" X 1/8" Rad Edge	1.44
2" X 3/16" Rad Edge	2.15
2" X 1/4" Rad Edge	2.87
2" X 3/8" Rad Edge	4.31
2" X 1/2" Rad Edge	5.74
2" X 3/4" Rad Edge	8.61
2 1/2" X 1/4" Rad Edge	3.59
2 1/2" X 3/8" Rad Edge	5.39
2 1/2" X 1/2" Rad Edge	7.18
3" X 1/4" Rad Edge	4.31
3" X 3/8" Rad Edge	6.46
3" X 1/2" Rad Edge	8.61
4" X 1/4" Rad Edge	5.74
4" X 3/8" Rad Edge	8.62
4" X 1/2" Rad Edge	11.48
5" X 1/4" Rad Edge	7.18
5" X 1/2" Rad Edge	14.35
6" X 1/4" Rad Edge	8.61
20mm X 5mm Rad Edge	0.89
20mm X 6mm Rad Edge	1.07
20mm X 10mm Rad Edge	1.78
25mm X 3mm Rad Edge	0.67
25mm X 5mm Rad Edge	1.11
25mm X 6mm Rad Edge	1.34
25mm X 10mm Rad Edge	2.23
30mm X 3mm Rad Edge	0.80
30mm X 5mm Rad Edge	1.34
30mm X 6mm Rad Edge	1.60
30mm X 10mm Rad Edge	2.67
40mm X 5mm Rad Edge	1.78
40mm X 6mm Rad Edge	2.14
40mm X 8mm Rad Edge	2.85
40mm X 10mm Rad Edge	3.56
50mm X 5mm Rad Edge	2.23
50mm X 6mm Rad Edge	2.67
50mm X 8mm Rad Edge	3.56
50mm X 10mm Rad Edge	4.45
50mm X 12mm Rad Edge	5.34
60mm X 6mm Rad Edge	3.20
60mm X 10mm Rad Edge	5.34
70mm X 10mm Rad Edge	6.23
80mm X 8mm Rad Edge	5.70
80mm X 10mm Rad Edge	7.12
100mm X 6mm Rad Edge	5.34
100mm X 10mm Rad Edge	8.90
120mm X 10mm Rad Edge	10.68

Flat Bar



Copper Flat Bar - Radius Edge - Alloy CW004A/C101 (continued)

Size	KG/Metre
150mm X 6mm Rad Edge	8.01
150mm X 10mm Rad Edge	13.35
160mm X 10mm Rad Edge	14.24
200mm X 10mm Rad Edge	17.80

Rod



Copper Rod CW004A/C101 - Hard Drawn High Conductivity

Size	KG/Metre
1/4" DIA	0.28
3/16" DIA	0.44
3/8" DIA	0.63
1/2" DIA	1.13
5/8" DIA	1.76
3/4" DIA	2.54
7/8" DIA	3.45
1" DIA	4.51
1 1/8" DIA	5.71
1 1/4" DIA	7.05
1 3/8" DIA	8.53
1 1/2" DIA	10.1
1 5/8" DIA	11.9
2" DIA	18.0
2 1/4" DIA	22.8
2 1/2" DIA	28.2
4" DIA	72.2
10.0mm DIA	0.70
12.0mm DIA	1.01
16.0mm DIA	1.79
20.0mm DIA	2.80
25.0mm DIA	4.37
30.0mm DIA	6.29
40.0mm DIA	11.2
50.0mm DIA	17.5

Round Tube



Copper Tube Alloy CW024A/C106

Size	KG/Metre
1/4 o/d X 20 swg	0.14
1/4 o/d X 18 swg	0.17
3/8 o/d X 20 swg	0.22
3/8 o/d X 18 swg	0.29
1/2 o/d X 20 swg	0.30
1/2 o/d X 18 swg	0.39
1/2 o/d X 16 swg	0.50
3/4 o/d X 20 swg	0.38
3/4 o/d X 18 swg	0.46
3/4 o/d X 16 swg	0.61
3/4 o/d X 14 swg	0.79
7/8 o/d X 20 swg	0.54
7/8 o/d X 18 swg	0.72
7/8 o/d X 16 swg	0.94
1 o/d X 20 swg	0.63
1 o/d X 18 swg	0.83
1 o/d X 16 swg	1.08
1 1/4 o/d X 16 swg	1.37
1 1/2 o/d X 16 swg	1.66
2 o/d X 16 swg	2.24
2 1/2 o/d X 16 swg	2.81

continued...

Bronze Rod



Aluminium Bronze Rod CW307G/CA104

Size	KG/Metre
1/2"	0.96
3/8"	1.50
3/4"	2.35
1"	3.85
1 1/4"	6.10
1 1/2"	8.66
1 3/4"	12.00
2"	15.40
2 1/4"	21.00
2 1/2"	24.90
2 3/4"	29.60
3"	34.70
3 1/2"	47.20
4"	61.60
4 1/2"	78.0
5"	96.3
5 1/2"	116
6"	139
6 1/2"	165
7"	189
7 1/2"	249
8"	276
9"	312
10"	385
12"	556

Aluminium Bronze Rod DEF-STAN 833 (NES 833) Grade 1

Size	KG/Metre
3/8"	0.54
1/2"	0.96
5/8"	1.50
3/4"	2.17
7/8"	2.96
1"	3.85
1 1/4"	6.02
1 1/2"	8.66
1 3/4"	11.8
2"	15.4
2 1/2"	24.1
3"	34.7
3 1/2"	47.2
4"	61.6
4 1/2"	78.0
5"	96.3
5 1/2"	116
6"	139
6 1/2"	165
7"	189
8"	249

Phosphor Bronze Rod CW451K/PB102

Size	KG/Metre
1/2"	1.12
5/8"	1.75
3/4"	2.52
7/8"	3.43
1"	4.48
1 1/8"	5.68
1 1/4"	7.01
1 3/8"	8.48
1 1/2"	10.0
1 3/4"	13.7
2"	17.9
2 1/4"	22.7
2 1/2"	28.0
2 3/4"	33.9
3"	40.4
3 1/4"	47.6
3 1/2"	54.9
4"	71.7



www.aalco.co.uk

ABERDEEN

Unit 9B, Peterseat Drive
Peterseat Park
Altens Industrial Estate
Aberdeen
AB12 3HT
Tel: 01224 854810
Fax: 01224 871982
Email: aberdeen@aalco.co.uk

CHEPSTOW

Avenue West
Newhouse Park Estate
Chepstow
Monmouthshire
NP16 6UD
Tel: 01291 638 638
Fax: 01291 638 600
Email: chepstow@aalco.co.uk

HULL

Saxon Way
Priory Park West
Hessle
Hull
HU13 9PB
Tel: 01482 626262
Fax: 01482 626263
Email: hull@aalco.co.uk

NEWCASTLE

First Avenue
Team Valley Trading Estate
Gateshead
Tyne & Wear
NE11 0NU
Tel: 0191 491 1133
Fax: 0191 491 1177
Email: newcastle@aalco.co.uk

SOUTHAMPTON

Test Lane
Nursling
Southampton
SO16 9TA
Tel: 023 8087 5200
Fax: 023 8087 5275
Email: southampton@aalco.co.uk

AYLESBURY

Unit 1, Premus
Coldharbour Way
Aylesbury
Buckinghamshire
HP19 8AP
Tel: 01296 461700
Fax: 01296 339923
Email: aylesbury@aalco.co.uk

DYFED

Units 3-4
Capel Hendre Industrial Estate
Ammanford
Carmarthenshire
SA18 3SJ
Tel: 01269 842044
Fax: 01269 845276
Email: dyfed@aalco.co.uk

LEEDS

Unit 1
Revie Road off Elland Road
Leeds
LS11 8JG
Tel: 0113 276 3300
Fax: 0113 276 0382
Email: leeds@aalco.co.uk

NORWICH

Roundtree Way
Mousehold Lane
Norwich
NR7 8SR
Tel: 01603 787878
Fax: 01603 789999
Email: norwich@aalco.co.uk

STOKE

Unit F, Forge Way
Brown Lees Industrial Estate
Biddulph
Stoke-on-Trent
ST8 7DN
Tel: 01782 375700
Fax: 01782 375701
Email: stoke@aalco.co.uk

BELFAST

The Belfast Metal Centre
20 McKinney Road
Newtownabbey
BT36 4PE
Tel: 02890 838 838
Fax: 02890 837 837
Email: belfast@aalco.co.uk

ESSEX

Unit 2, Carnival Park
Festival Way
Basildon
Essex
SS14 3WN
Tel: 01268 884200
Fax: 01268 884220
Email: essex@aalco.co.uk

LIVERPOOL

207 Great Howard Street
Liverpool
L5 9ZH
Tel: 0151 207 3551
Fax: 0151 207 2657
Email: liverpool@aalco.co.uk

NOTTINGHAM

Harrimans Lane
Dunkirk
Nottingham
NG7 2SD
Tel: 0115 988 2600
Fax: 0115 988 2636
Email: nottingham@aalco.co.uk

SWANLEY

Unit 7
The Interchange
Wested Lane
Swanley, Kent
BR8 8TE
Tel: 01322 610900
Fax: 01322 610910
Email: swanley@aalco.co.uk

BIRMINGHAM

Shelah Road
Halesowen
West Midlands
B63 3PH
Tel: 0121 585 3600
Fax: 0121 585 6864
Email: birmingham@aalco.co.uk

GLASGOW

117 Clydesmill Place
Cambuslang Investment Park
Glasgow
G32 8RF
Tel: 0141 646 3200
Fax: 0141 646 3260
Email: glasgow@aalco.co.uk

MANCHESTER

Express Trading Estate
Stone Hill Road
Farnworth
Bolton
BL4 9NN
Tel: 01204 863456
Fax: 01204 863430
Email: manchester@aalco.co.uk

AMARI also available in Ireland

DUBLIN

Tel: +353 (0) 1 629 8600
Fax: +353 (0) 1 629 9200
Email: dublin@amari-dublin.com



CORK

Tel: +353 (0) 21 4310 520
Fax: +353 (0) 21 4310 519
Email: cork@amari-cork.com