

Stainless  
Steel  
Tubular  
Products

*aalco*<sup>®</sup>

### **Disclaimer**

This Data is indicative only and as such is not to be relied upon in place of the full specification. In particular, mechanical property requirements vary widely with temper, product and product dimensions. All information is based on our present knowledge and is given in good faith. No liability will be accepted by the Company in respect of any action taken by any third party in reliance thereon.

Please note that the Issue date shown below is no guarantee of accuracy or whether the information herein is up to date or is from the most recent references available at that date.

The information provided in this publication has been drawn from various recognised sources, including EN Standards, recognised industry references (printed & online) and manufacturers' data. No guarantee is given that the information is from the latest issue of those sources or about the accuracy of those sources.

Material supplied by the Company may vary significantly from this data, but will conform to all relevant and applicable standards.

As the products detailed may be used for a wide variety of purposes and as the Company has no control over their use; the Company specifically excludes all conditions or warranties expressed or implied by statute or otherwise as to dimensions, properties and/or fitness for any particular purpose, whether expressed or implied.

Advice given by the Company to any third party is given for that party's assistance only and without liability on the part of the Company. All transactions are subject to the Company's current Conditions of Sale. The extent of the Company's liabilities to any customer is clearly set out in those Conditions; a copy of which is available on request.

### **Weights**

All weights shown in this publication are for guidance only. They are calculated using nominal dimensions and scientifically recognised densities. Please note that in practice, the actual weight can vary significantly from the theoretical weight due to variations in manufacturing tolerances and compositions.

Copyright 2015: All Rights reserved: Aalco Metals Limited. No part of this publication may be reproduced, stored in a retrieval system or transmitted in any form or by any means, electronic, mechanical, recording or otherwise without the prior written consent of the proprietor.

Aalco is a registered trade mark of Aalco Metals Limited.

Issue No. 2 – March 2018

## Stainless Steel Tubular Products

<b>Introduction</b>	<b>The Company and Stock Range</b>	<b>2</b>
<b>Section 1</b>	<b>ASTM Pipe</b>	<b>1-1</b>
<b>Section 2</b>	<b>ASTM Tube</b>	<b>2-1</b>
<b>Section 3</b>	<b>Butt Weld Fittings</b>	<b>3-1</b>
<b>Section 4</b>	<b>BSP Fittings</b>	<b>4-1</b>
<b>Section 5</b>	<b>Flanges</b>	<b>5-1</b>
<b>Section 6</b>	<b>Hygienics</b>	<b>6-1</b>
<b>Section 7</b>	<b>Metric Tube &amp; Fittings</b>	<b>7-1</b>
<b>Section 8</b>	<b>General Information</b>	<b>8-1</b>

**Aalco is the UK's largest independent multi-metals stockholder. Customers from every sector of the UK manufacturing and engineering industries, whether small local businesses or large multinational corporations, benefit from a cost-effective single source for all their metals requirements.**

Aalco – delivering customer service and investing in capability:

- ◊ An inventory that includes aluminium, stainless steel, copper, brass, bronze and nickel alloys in all semi-finished forms
- ◊ Comprehensive processing services providing items cut and/or finished to customer requirements
- ◊ Eighteen locations bringing local service to every corner of the UK
- ◊ Ongoing investment in technology and logistics to ensure on-time delivery

No order is too large or too small and Aalco offers a responsive and competitive service for supplying anything from single item orders to major JIT contracts, tailoring this service to individual needs.

Whatever your requirement, in whatever quantity, your local Aalco service centre is ready and willing to satisfy your needs. For a quotation, for further information, more extensive technical information, advice on product selection or to place an order, please contact your local Aalco service centre or refer to the web site [www.aalco.co.uk](http://www.aalco.co.uk).

## **Service**

The most comprehensive stock range; the highest investment in processing equipment; local service centres nationwide; helpful, friendly, knowledgeable staff and the industry's biggest fleet of delivery vehicles – it all adds up to unbeatable service.

Aalco has maintained market leadership over many years through an absolute dedication to customer service – a service level that is continuously monitored and improved through key performance indicators.

That's why, for reliable, on-time delivery of exactly what you want, when and where you need it, whether it's a small one-off item or a complex JIT contract, Aalco is the essential first choice.

## **People**

Exceptional customer service starts with people. Aalco develops and retains high quality personnel using a variety of 'in house' courses which cover both skills training, product knowledge and teamwork.

Every Aalco service centre has a dedicated team of people working together to provide an unbeatable service to customers in their region. Customers can expect to receive a quick and informed response to any enquiries for material or for information.

## **Quality**

Aalco takes great care when selecting manufacturing sources for its products and every mill we use is measured against a series of predetermined quality control requirements. All products supplied by Aalco conform to the relevant BS or international standards. Certification can be supplied on request.

Aalco service centres operate a quality manual designed to ISO9001/2008 requirements. Many vendor approvals and bespoke quality control systems are operated through individual Aalco service centres.

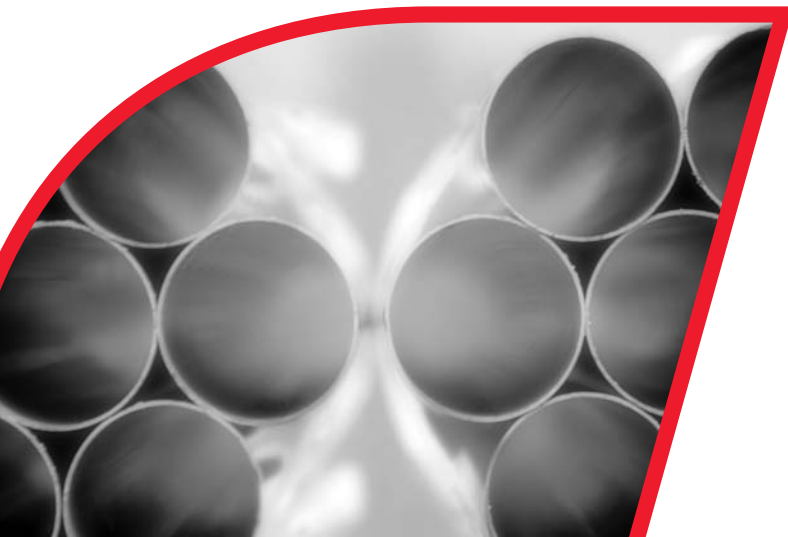



## Tube

Seamless to ASTM A269, imperial sizes from 1/8" O/D x 24swg to 4" O/D x 1/4" wall in grade 316L

Seamless to ASTM A269, grades 304L & 316L, in metric sizes 6mm O/D x 0.5mm wall to 38mm O/D x 4mm wall

Decorative – Round, Square, Rectangular

Structural – Square and Rectangular up to 250mm

Hygienic (see below)

Welded Metric Nominal Internal Diameter (see below)

## Pipe

Seamless and Welded to ASTM A312 from 1/8" to 24" in grades 304L & 316L

## Flanges

ASTM A182 / ANSI B16.5

BS 10 Table E, Grade 316L

BS 4504 / EN 1092 Raised Face, 16 Bar

Backing Flanges in Aluminium and Coated Mild Steel

## Fittings

Butt Weld Fittings, Seamless and Welded, to ASTM A403 in grades 304L & 316L including elbows, tees & reducers

BSP Screwed Fittings, grade 316 from 1/8" to 3"

Hygienic fittings (see below)

Welded Metric Nominal Internal Diameter (see below)

## Hygienic Tube and Fittings

Grades 304L & 316L 3/4" O/D to 4" O/D:

Tube – As Welded & Descaled, Annealed & Polished or Bright Annealed

Bends, Fitted Bends, Tees, Reducers, Clamps & Tube Hangers

Unions – RJT, IDF & DIN

## Metric – Welded Nominal Internal Diameter (ND)

From 18mm O/D x 1.5mm wall to 910mm O/D x 5mm wall

Grades 1.4432 (316L High Molybdenum) & 1.4307 (304L)

Tube, Elbows, Tees, Reducers, Collars, End Caps, Tube Clamps & Clips

Backing Flanges in Aluminium & Coated Mild Steel

Further information is provided by these publications, available either from your local Service Centre or at [www.aalco.co.uk](http://www.aalco.co.uk)



### Product Guide

Technical information on applications, uses and specifications for stainless

steel, aluminium, copper, brass and bronze.

### Stocklist



in stainless steel, aluminium, copper, brass and bronze.

A guide to the Aalco standard stock range



### Metric

A guide to the range of light-walled nominal diameter metric stainless steel tubular products used

in water treatment, pulp & paper and other industries.



### Handrail

A guide to the Aalco range of stainless steel handrail/balustrade systems

comprising tube and slotted tube plus associated fittings.

# ASTM Pipe

## Introduction

The term pipe covers a specific range of sizes laid down by ANSI specifications. Any sizes not covered by these specifications are tube. Stainless Steel Pipe dimensions determined by ASME B36.19 covering the outside diameter and the Schedule wall thickness. Note that stainless wall thicknesses to ANSI B36.19 all have an 'S' suffix. Sizes without an 'S' suffix are to ANSI B36.10 which is intended for carbon steel pipes.



### Seamless and Welded

**ASTM A312:** Seamless and straight-seam welded austenitic pipe intended for high temperature and general corrosive service. Filler metal not permitted during welding.

**ASTM A358:** Electric fusion welded austenitic pipe for corrosive and/or high temperature service. Typically only pipe up to 8 inch is produced to this specification. Addition of filler metal is permitted during welding.

**ASTM A790:** Seamless and straight-seam welded ferritic/austenitic (duplex) pipe intended for general corrosive service, with a particular emphasis on resistance to stress corrosion cracking.

**ASTM A409:** Straight-seam or spiral-seam electric fusion welded large diameter austenitic light-wall pipe in sizes 14" to 30" with walls Sch 5S and Sch 10S for corrosive and/or high temperature service.

**ASTM A376:** Seamless austenitic pipe for high temperature applications.

**ASTM A813:** Single-seam, single- or double- welded austenitic pipe for high temperature and general corrosive applications.

**ASTM A814:** Cold-worked welded austenitic pipe for high temperature and general corrosive service.

**Note:** Welded pipes manufactured to ASTM A312, A790 and A813 must be produced by an automatic process with NO addition of filler metal during the welding operation.

### Welded pipe specifications

Usually it will be to ASTM A312. If it is to ASTM A358 then there are various Classes available as shown below. The Class Number dictates how the pipe is welded and what non-destructive tests:

- ◊ **Class 1:** Pipe shall be double welded by processes employing filler metal in all passes and shall be completely radiographed.
- ◊ **Class 2:** Pipe shall be double welded by processes employing filler metal in all passes. No-radiography is required.
- ◊ **Class 3:** Pipe shall be welded in one pass by processes employing filler metal and shall be completely radiographed.
- ◊ **Class 4:** Same as Class 3 except that the welding process exposed to the inside pipe surface may be made without the addition of filler metal.
- ◊ **Class 5:** Pipe shall be double welded by processes employing filler metal in all passes and shall be spot radiographed.

### Markings on pipe

The full identification of the pipe should be continuously marked down its whole length, including:

- ◊ Nominal Pipe Size (Nominal Bore)
- ◊ Schedule (Wall Thickness)
- ◊ Specification
- ◊ Grade
- ◊ Method of Manufacture (Seamless or Welded)
- ◊ Heat Number
- ◊ Manufacturer's Name or Symbol

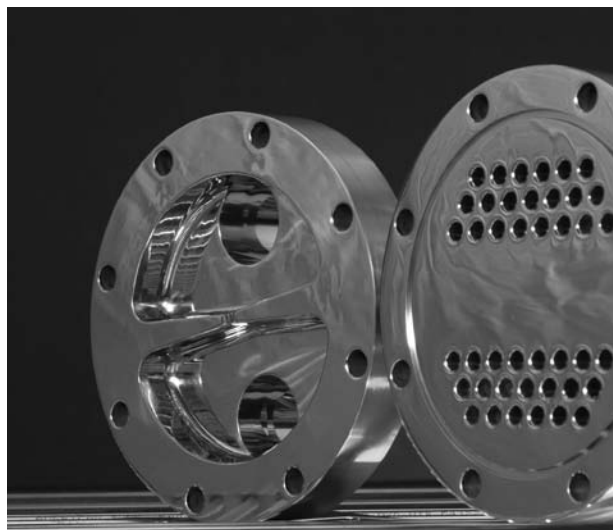



### Dimensions and weights per metre - stainless steel pipe

Nominal Pipe Size	OD		Schedule 5S <sup>1</sup>			Schedule 10S <sup>1</sup>			Schedule 40S			Schedule 80S		
	in	mm	in	mm	kg/m	in	mm	kg/m	in	mm	kg/m	in	mm	kg/m
1/8	0.405	10.3	-	-	-	0.049	1.24	0.28	0.068	1.73	0.37	0.095	2.41	0.47
1/4	0.540	13.7	-	-	-	0.065	1.65	0.49	0.088	2.24	0.63	0.119	3.02	0.80
3/8	0.675	17.1	-	-	-	0.065	1.65	0.63	0.091	2.31	0.84	0.126	3.20	1.10
1/2	0.840	21.3	0.065	1.65	0.80	0.083	2.11	1.00	0.109	2.77	1.27	0.147	3.73	1.62
3/4	1.050	26.7	0.065	1.65	1.03	0.083	2.11	1.28	0.113	2.87	1.69	0.154	3.91	2.20
1	1.315	33.4	0.065	1.65	1.30	0.109	2.77	2.09	0.133	3.38	2.50	0.179	4.55	3.24
1 1/4	1.660	42.2	0.065	1.65	1.65	0.109	2.77	2.70	0.140	3.56	3.39	0.191	4.85	4.47
1 1/2	1.900	48.3	0.065	1.65	1.91	0.109	2.77	3.11	0.145	3.68	4.05	0.200	5.08	5.41
2	2.375	60.3	0.065	1.65	2.40	0.109	2.77	3.93	0.154	3.91	5.44	0.218	5.54	7.48
2 1/2	2.875	73.0	0.083	2.11	3.69	0.120	3.05	5.26	0.203	5.16	8.63	0.276	7.01	11.41
3	3.500	88.9	0.083	2.11	4.51	0.120	3.05	6.45	0.216	5.49	11.29	0.300	7.62	15.27
3 1/2	4.000	101.6	0.083	2.11	5.18	0.120	3.05	7.40	0.226	5.74	13.57	0.318	8.08	18.63
4	4.500	114.3	0.083	2.11	5.84	0.120	3.05	8.36	0.237	6.02	16.07	0.337	8.56	22.32
5	5.563	141.3	0.109	2.77	9.47	0.134	3.40	11.57	0.258	6.55	21.77	0.375	9.53	30.97
6	6.625	168.3	0.109	2.77	11.32	0.134	3.40	13.84	0.280	7.11	28.26	0.432	10.97	42.56
8	8.625	219.1	0.109	2.77	14.79	0.148	3.76	19.96	0.322	8.18	42.55	0.500	12.70	64.64
10	10.750	273.1	0.134	3.40	22.63	0.165	4.19	27.78	0.365	9.27	60.31	0.500 <sup>2</sup>	12.70 <sup>2</sup>	96.01 <sup>2</sup>
12	12.750	323.9	0.156	3.96	31.25	0.180	4.57	36.00	0.375 <sup>2</sup>	9.53 <sup>2</sup>	73.88 <sup>2</sup>	0.500 <sup>2</sup>	12.70 <sup>2</sup>	132.08 <sup>2</sup>
14	14.000	355.6	0.156	3.96	34.36	0.188 <sup>2</sup>	4.78 <sup>2</sup>	41.30 <sup>2</sup>	-	-	-	-	-	-
16	16.000	406.4	0.165	4.19	41.56	0.188 <sup>2</sup>	4.78 <sup>2</sup>	47.29 <sup>2</sup>	-	-	-	-	-	-
18	18.000	457	0.165	4.19	46.81	0.188 <sup>2</sup>	4.78 <sup>2</sup>	53.26 <sup>2</sup>	-	-	-	-	-	-
20	20.000	508	0.188	4.78	59.25	0.218 <sup>2</sup>	5.54 <sup>2</sup>	68.61 <sup>2</sup>	-	-	-	-	-	-
22	22.000	559	0.188	4.78	65.24	0.218 <sup>2</sup>	5.54 <sup>2</sup>	75.53 <sup>2</sup>	-	-	-	-	-	-
24	24.000	610	0.218	5.54	82.47	0.250	6.35	94.45	-	-	-	-	-	-
30	30.000	762	0.250	6.35	118.31	0.312	7.92	147.36	-	-	-	-	-	-

Notes

- 1 Schedules 5S and 10S wall thicknesses do not permit threading in accordance with ANSI/ASME B1.20.1.
- 2 These dimensions and weights do not conform to ANSI/ASME B36.10M.
  - The suffix 'S' after the schedule number indicates that the pipe dimensions and weight are in compliance with this stainless steel pipe specification, ANSI/ASME B36.19M-1985, and not the more general ANSI/ASME B36.10M-1995 specification.
  - Although this specification is applicable to stainless steel, quoted weights are for carbon steel pipe and should be multiplied by 1.014 for austenitic and duplex steels, or by 0.985 for ferritic and martensitic steels.

# ASTM Pipe

## Pipe Sizes - ANSI/ASME B36.10M

### Dimensions and weights per metre - steel pipe

Nominal Pipe Size	OD		Schedule 10			Schedule 20			Schedule 30			Schedule 40		
	in	mm	in	mm	kg/m	in	mm	kg/m	in	mm	kg/m	in	mm	kg/m
1/8	0.405	10.3	-	-	-	-	-	-	0.057	1.45	0.32	0.068	1.73	0.37
1/4	0.540	13.7	-	-	-	-	-	-	0.073	1.85	0.54	0.088	2.24	0.63
3/8	0.675	17.1	-	-	-	-	-	-	0.073	1.85	0.70	0.091	2.31	0.84
1/2	0.840	21.3	-	-	-	-	-	-	0.095	2.41	1.12	0.109	2.77	1.27
3/4	1.050	26.7	-	-	-	-	-	-	0.095	2.41	1.44	0.113	2.87	1.69
1	1.315	33.4	-	-	-	-	-	-	0.114	2.90	2.18	0.133	3.38	2.50
1 1/4	1.660	42.2	-	-	-	-	-	-	0.117	2.97	2.87	0.140	3.56	3.39
1 1/2	1.900	48.3	-	-	-	-	-	-	0.125	3.18	3.53	0.145	3.68	4.05
2	2.375	60.3	-	-	-	-	-	-	0.125	3.18	4.48	0.154	3.91	5.44
2 1/2	2.875	73.0	-	-	-	-	-	-	0.188	4.78	8.04	0.203	5.16	8.63
3	3.500	88.9	-	-	-	-	-	-	0.188	4.78	9.92	0.216	5.49	11.29
3 1/2	4.000	101.6	-	-	-	-	-	-	0.188	4.78	11.41	0.226	5.74	13.57
4	4.500	114.3	-	-	-	-	-	-	0.188	4.78	12.91	0.237	6.02	16.07
5	5.563	141.3	-	-	-	-	-	-	-	-	-	0.258	6.55	21.77
6	6.625	168.3	-	-	-	-	-	-	-	-	-	0.280	7.11	28.26
8	8.625	219.1	-	-	-	0.250	6.35	33.31	0.277	7.04	36.81	0.322	8.18	42.55
10	10.750	273.0	-	-	-	0.250	6.35	41.77	0.307	7.80	51.03	0.365	9.27	60.31
12	12.750	323.8	-	-	-	0.250	6.35	49.73	0.330	8.38	65.20	0.406	10.31	79.73
14	14.000	355.6	0.250	6.35	54.69	0.312	7.92	67.90	0.375	9.53	81.33	0.438	11.13	94.55
16	16.000	406.4	0.250	6.35	62.64	0.312	7.92	77.83	0.375	9.53	93.27	0.500	12.70	123.30
18	18.000	457	0.250	6.35	70.57	0.312	7.92	87.71	0.438	11.13	122.38	0.562	14.27	155.80
20	20.000	508	0.250	6.35	78.55	0.375	9.53	117.15	0.500	12.70	155.12	0.594	15.09	183.42
22	22.000	559	0.250	6.35	86.54	0.375	9.53	129.13	0.500	12.70	171.09	-	-	-
24	24.000	610	0.250	6.35	94.53	0.375	9.53	141.12	0.562	14.27	209.64	0.688	17.48	255.41
26	26.000	660	0.312	7.92	127.36	0.500	12.70	202.72	-	-	-	-	-	-
28	28.000	711	0.312	7.92	137.32	0.500	12.70	218.69	0.625	15.88	271.21	-	-	-
30	30.000	762	0.312	7.92	147.28	0.500	12.70	234.67	0.625	15.88	292.18	-	-	-
32	32.000	813	0.312	7.92	157.24	0.500	12.70	250.64	0.625	15.88	312.15	0.688	17.48	342.91
34	34.000	864	0.312	7.92	167.20	0.500	12.70	266.61	0.625	15.88	332.12	0.688	17.48	364.90
36	36.000	914	0.312	7.92	176.96	0.500	12.70	282.27	0.625	15.88	351.70	0.750	19.05	420.42
38	38.000	965	-	-	-	-	-	-	-	-	-	-	-	-
40	40.000	1016	-	-	-	-	-	-	-	-	-	-	-	-
42	42.000	1067	-	-	-	-	-	-	-	-	-	-	-	-
44	44.000	1118	-	-	-	-	-	-	-	-	-	-	-	-
46	46.000	1168	-	-	-	-	-	-	-	-	-	-	-	-
48	48.000	1219	-	-	-	-	-	-	-	-	-	-	-	-

**Notes**

- This specification is applicable to all steel pipe including stainless steel. Quoted weights are for carbon steel pipe and should be multiplied by 1.014 for austenitic and duplex steels, or by 0.985 for ferritic and martensitic steels.



### Dimensions and weights per metre - steel pipe

Nominal Pipe Size	OD		Schedule (STD)			Schedule 60			Extra Strong (XS)			Schedule 80		
	in	mm	in	mm	kg/m	in	mm	kg/m	in	mm	kg/m	in	mm	kg/m
1/8	0.405	10.3	0.068	1.73	0.37	-	-	-	0.095	2.41	0.47	0.095	2.41	0.47
1/4	0.540	13.7	0.088	2.24	0.63	-	-	-	0.119	3.02	0.80	0.119	3.02	0.80
3/8	0.675	17.1	0.091	2.31	0.84	-	-	-	0.126	3.20	1.10	0.126	3.20	1.10
1/2	0.840	21.3	0.109	2.77	1.27	-	-	-	0.147	3.73	1.62	0.147	3.73	1.62
3/4	1.050	26.7	0.113	2.87	1.69	-	-	-	0.154	3.91	2.20	0.154	3.91	2.20
1	1.315	33.4	0.133	3.38	2.50	-	-	-	0.179	4.55	3.24	0.179	4.55	3.24
1 1/4	1.660	42.2	0.140	3.56	3.39	-	-	-	0.191	4.85	4.47	0.191	4.85	4.47
1 1/2	1.900	48.3	0.145	3.68	4.05	-	-	-	0.200	5.08	5.41	0.200	5.08	5.41
2	2.375	60.3	0.154	3.91	5.44	-	-	-	0.218	5.54	7.48	0.218	5.54	7.48
2 1/2	2.875	73.0	0.203	5.16	8.63	-	-	-	0.276	7.01	11.41	0.276	7.01	11.41
3	3.500	88.9	0.216	5.49	11.29	-	-	-	0.300	7.62	15.27	0.300	7.62	15.27
3 1/2	4.000	101.6	0.226	5.74	13.57	-	-	-	0.318	8.08	18.63	0.318	8.08	18.63
4	4.500	114.3	0.237	6.02	16.07	-	-	-	0.337	8.56	22.32	0.337	8.56	22.32
5	5.563	141.3	0.258	6.55	21.77	-	-	-	0.375	9.53	30.97	0.375	9.53	30.97
6	6.625	168.3	0.280	7.11	28.26	-	-	-	0.432	10.97	42.56	0.432	10.97	42.56
8	8.625	219.1	0.322	8.18	42.55	0.406	10.31	53.08	0.500	12.70	64.64	0.500	12.70	64.64
10	10.750	273.0	0.365	9.27	60.31	0.500	12.70	81.55	0.500	12.70	81.55	0.594	15.09	96.01
12	12.750	323.8	0.375	9.53	73.88	0.562	14.27	108.96	0.500	12.70	97.46	0.688	17.48	132.08
14	14.000	355.6	0.375	9.53	81.33	0.594	15.09	126.71	0.500	12.70	107.39	0.750	19.05	158.10
16	16.000	406.4	0.375	9.53	93.27	0.656	16.66	160.12	0.500	12.70	123.30	0.844	21.44	203.53
18	18.000	457	0.375	9.53	105.16	0.750	19.05	205.74	0.500	12.70	139.15	0.938	23.83	254.55
20	20.000	508	0.375	9.53	117.15	0.812	20.62	247.83	0.500	12.70	155.12	1.031	26.19	311.17
22	22.000	559	0.375	9.53	129.13	0.875	22.23	294.25	0.500	12.70	171.09	1.125	28.58	373.83
24	24.000	610	0.375	9.53	141.12	0.969	24.61	355.26	0.500	12.70	187.06	1.219	30.96	442.08
26	26.000	660	0.375	9.53	152.87	-	-	-	0.500	12.70	202.72	-	-	-
28	28.000	711	0.375	9.53	164.85	-	-	-	0.500	12.70	218.69	-	-	-
30	30.000	762	0.375	9.53	176.84	-	-	-	0.500	12.70	234.67	-	-	-
32	32.000	813	0.375	9.53	188.82	-	-	-	0.500	12.70	250.64	-	-	-
34	34.000	864	0.375	9.53	200.31	-	-	-	0.500	12.70	266.61	-	-	-
36	36.000	914	0.375	9.53	212.56	-	-	-	0.500	12.70	282.27	-	-	-
38	38.000	965	0.375	9.53	224.54	-	-	-	0.500	12.70	298.24	-	-	-
40	40.000	1016	0.375	9.53	236.53	-	-	-	0.500	12.70	314.22	-	-	-
42	42.000	1067	0.375	9.53	248.52	-	-	-	0.500	12.70	330.19	-	-	-
44	44.000	1118	0.375	9.53	260.50	-	-	-	0.500	12.70	346.16	-	-	-
46	46.000	1168	0.375	9.53	272.25	-	-	-	0.500	12.70	351.82	-	-	-
48	48.000	1219	0.375	9.53	284.24	-	-	-	0.500	12.70	377.79	-	-	-

**Notes**

- This specification is applicable to all steel pipe including stainless steel. Quoted weights are for carbon steel pipe and should be multiplied by 1.014 for austenitic and duplex steels, or by 0.985 for ferritic and martensitic steels.

# ASTM Pipe

## Pipe Sizes - ANSI/ASME B36.10M

### Dimensions and weights per metre - steel pipe

Nominal Pipe Size	OD		Schedule 100			Schedule 120			Schedule 140			Schedule 160		
	in	mm	in	mm	kg/m	in	mm	kg/m	in	mm	kg/m	in	mm	kg/m
1/2	0.840	21.3	-	-	-	-	-	-	-	-	-	0.188	4.78	1.95
3/4	1.050	26.7	-	-	-	-	-	-	-	-	-	0.219	5.56	2.90
1	1.315	33.4	-	-	-	-	-	-	-	-	-	0.250	6.35	4.24
1 1/4	1.660	42.2	-	-	-	-	-	-	-	-	-	0.250	6.35	5.61
1 1/2	1.900	48.3	-	-	-	-	-	-	-	-	-	0.281	7.14	7.25
2	2.375	60.3	-	-	-	-	-	-	-	-	-	0.344	8.74	11.11
2 1/2	2.875	73.0	-	-	-	-	-	-	-	-	-	0.375	9.53	14.92
3	3.500	88.9	-	-	-	-	-	-	-	-	-	0.438	11.13	21.35
3 1/2	4.000	101.6	-	-	-	-	-	-	-	-	-	-	-	-
4	4.500	114.3	-	-	-	0.438	11.13	28.32	-	-	-	0.531	13.49	33.54
5	5.563	141.3	-	-	-	0.500	12.70	40.28	-	-	-	0.625	15.88	49.11
6	6.625	168.3	-	-	-	0.562	14.27	54.20	-	-	-	0.719	18.26	67.56
8	8.625	219.1	0.594	15.09	75.92	0.719	18.26	90.44	0.812	20.62	100.92	0.906	23.01	111.27
10	10.750	273.0	0.719	18.26	114.75	0.844	21.44	133.06	1.000	25.40	155.15	1.125	28.58	172.33
12	12.750	323.8	0.844	21.44	159.91	1.000	25.40	186.97	1.125	28.58	208.14	1.312	33.32	238.76
14	14.000	355.6	0.938	23.83	194.96	1.094	27.79	224.65	1.250	31.75	253.56	1.406	35.71	281.70
16	16.000	406.4	1.031	26.19	245.56	1.219	30.96	286.64	1.438	36.53	333.19	1.594	40.49	365.35
18	18.000	457	1.156	29.36	309.62	1.375	34.93	363.56	1.562	39.67	408.26	1.781	45.24	459.37
20	20.000	508	1.281	32.54	381.53	1.500	38.10	441.49	1.750	44.45	508.11	1.969	50.01	564.81
22	22.000	559	1.375	34.93	451.42	1.625	41.28	527.02	1.875	47.63	600.63	2.125	53.98	672.26
24	24.000	610	1.531	38.89	547.71	1.812	46.02	640.03	2.062	52.37	720.15	2.344	59.54	808.22

Nominal Pipe Size	OD		Double Extra Strong (XXS)		
	in	mm	in	mm	kg/m
1/2	0.840	21.3	0.294	7.47	2.55
3/4	1.050	26.7	0.308	7.82	3.64
1	1.315	33.4	0.358	9.09	5.45
1 1/4	1.660	42.2	0.382	9.70	7.77
1 1/2	1.900	48.3	0.400	10.15	9.56
2	2.375	60.3	0.436	11.07	13.44
2 1/2	2.875	73.0	0.552	14.02	20.39
3	3.500	88.9	0.600	15.24	27.68

Nominal Pipe Size	OD		Double Extra Strong (XXS) continued		
	in	mm	in	mm	kg/m
continued					
3 1/2	4.000	101.6	-	-	-
4	4.500	114.3	0.674	17.12	41.03
5	5.563	141.3	0.750	19.05	57.43
6	6.625	168.3	0.864	21.95	79.22
8	8.625	219.1	0.875	22.23	107.92
10	10.750	273.0	1.000	25.40	155.15
12	12.750	323.8	1.000	25.40	186.97

**Notes**

- This specification is applicable to all steel pipe including stainless steel. Quoted weights are for carbon steel pipe and should be multiplied by 1.014 for austenitic and duplex steels, or by 0.985 for ferritic and martensitic steels.

## Chemical Compositions - ASTM A240/A240M

Grade	UNS	Composition Percentage, Max or Range																		
		Carbon	Manganese	Phosphorus	Sulphur	Silicon	Nickel	Chromium	Molybdenum	Titanium	Niobium	Tantalum	Nitrogen	Vanadium	Copper	Cerium	Boron	Aluminium	Tungsten	Selenium
		C	Mn	P	S	Si	Ni	Cr	Mo	Ti	Nb	Ta	N	Va	Cu	Ce	Bo	Al	W	Se
201	S20100	0.15	5.50-7.50	0.060	0.030	1.00	3.5-5.5	16.00-18.00	-	-	-	-	0.25	-	-	-	-	-	-	-
202	S20200	0.15	7.50-10.0	0.060	0.030	1.00	4.00-6.00	17.00-19.00	-	-	-	-	0.25	-	-	-	-	-	-	-
301	S30100	0.15	2.00	0.045	0.030	1.00	6.00-8.00	16.00-18.00	-	-	-	-	0.10	-	-	-	-	-	-	-
302	S30200	0.15	2.00	0.045	0.030	0.75	8.00-10.00	17.00-19.00	-	-	-	-	0.10	-	-	-	-	-	-	-
304	S30400	0.07	2.00	0.045	0.030	0.75	8.00-10.50	17.50-19.50	-	-	-	-	0.10	-	-	-	-	-	-	-
304L	S30403	0.030	2.00	0.045	0.030	0.75	8.00-12.00	17.50-19.50	-	-	-	-	0.10	-	-	-	-	-	-	-
304H	S30409	0.04-0.10	2.00	0.045	0.030	0.75	8.00-10.50	18.00-20.00	-	-	-	-	-	-	-	-	-	-	-	-
309S	S30908	0.08	2.00	0.045	0.030	0.75	12.00-15.00	22.00-24.00	-	-	-	-	-	-	-	-	-	-	-	-
310S	S31008	0.08	2.00	0.045	0.030	1.50	19.00-22.00	24.00-26.00	-	-	-	-	-	-	-	-	-	-	-	-
310H	S31009	0.04-0.10	2.00	0.045	0.030	0.75	19.00-22.00	24.00-26.00	-	-	-	-	-	-	-	-	-	-	-	-
316	S31600	0.08	2.00	0.045	0.030	0.75	10.00-14.00	16.00-18.00	2.00-3.00	-	-	-	0.10	-	-	-	-	-	-	-
316L	S31603	0.03	2.00	0.045	0.030	0.75	10.00-14.00	16.00-18.00	2.00-3.00	-	-	-	0.10	-	-	-	-	-	-	-
316H	S31609	0.04-0.10	2.00	0.045	0.030	0.75	10.00-14.00	16.00-18.00	2.00-3.00	-	-	-	-	-	-	-	-	-	-	-
317	S31700	0.08	2.00	0.045	0.030	0.75	11.00-15.00	18.00-20.00	3.00-4.00	-	-	-	0.10	-	-	-	-	-	-	-
317L	S31703	0.03	2.00	0.045	0.030	0.75	11.00-15.00	18.00-20.00	3.00-4.00	-	-	-	0.10	-	-	-	-	-	-	-
321	S32100	0.08	2.00	0.045	0.030	0.75	9.00-12.00	17.00-19.00	-	5x(C+N) min, 0.70 max	-	-	0.10	-	-	-	-	-	-	-
347	S34700	0.08	2.00	0.045	0.030	0.75	9.00-13.00	17.00-19.00	-	-	10xC min, 1.00 max	-	-	-	-	-	-	-	-	-
409	S40910	0.03	1.00	0.040	0.020	1.00	0.50	10.50-11.70	-	6xC min, 0.5 max	0.17	-	0.03	-	-	-	-	-	-	-
410	S41000	0.08-0.15	1.00	0.040	0.030	1.00	0.75	11.5-13.5	-	-	-	-	-	-	-	-	-	-	-	-
430	S43000	0.12	1.00	0.040	0.030	1.00	0.75	16.00-18.00	-	-	-	-	-	-	-	-	-	-	-	-
439	S43035	0.03	1.00	0.040	0.030	1.00	0.050	17.00-19.00	-	0.20 + 4(C+N) min, 1.10 max	-	-	0.03	-	-	-	-	0.15	-	-

Please note, as shown at the top of the page, these values are to ASTM A 240. Some tube, pipe and fittings specifications may call for different values, although all values do have a tolerance. If in doubt please consult the original specification for the particular product.

# ASTM Pipe

## Dimensional Tolerances - ASTM A530/A530M

### Standard cross-section and weight tolerances (ASTM A530/A530M)

NPS	Outside Diameter (OD) <sup>1</sup>				Wall Thickness (t) <sup>2</sup>		Weight <sup>3</sup>	
	Under		Over		Under	Over	Under	Over
	in	mm	in	mm	%	%	%	%
1/8 to 1 1/2	0.031	0.8	0.015	0.4	12.5	20	3.5	10
>1 1/2 to 4	0.031	0.8	0.031	0.8	12.5	20	3.5	10
>4 to 8	0.031	0.8	0.062	1.6	12.5	22.5	3.5	10
>8 to 12	0.031	0.8	0.093	2.4	12.5	22.5	3.5	10
>12 to 18	0.031	0.8	0.093	2.4	12.5	22.5	5	10
>18 to 26	0.031	0.8	0.125	3.2	12.5	22.5	5	10
>26 to 34	0.031	0.8	0.156	4.0	12.5	22.5	5	10
>34 to 48	0.031	0.8	0.187	4.8	12.5	22.5	5	10

#### Notes

1 Includes ovality tolerance except for thin wall pipe (i.e.  $t > 3\%$  OD).

2 Min wall thickness = Nominal wall thickness (t) x 0.875. Not applicable if filler metal added.

3 Refer to pages 1-2 to 1-5 for standard pipe weights. For non standard pipes  $W(\text{lb/ft}) = 10.68(\text{OD}-t)t$ , or  $W(\text{kg/m}) = 0.02466(\text{OD}-t)t$

#### ◊ Standard Cut Lengths. Pipe ordering alternatives are:

- **Random.** Standard lengths are in the range 15 to 24 feet. Shorter lengths as agreed with the purchaser.
- **Specified Lengths.** Cut lengths as specified, with end finish also specified.

#### ◊ Length tolerances. No pipe shall be shorter than specified. No pipe shall be more than 1/4 in (6mm) longer than specified. Tighter tolerances may be specified, e.g. for bevelled pipe.

#### ◊ Straightness. All finished pipe shall be reasonably straight. For metal-arc welded pipe maximum deviation from straight = 1/8 in (3.2mm) in 10 ft (3 m).

### Seamless and welded austenitic stainless steel pipes

This specification covers austenitic steel pipe intended for high temperature and general corrosive service. H grades in the chemical composition table are specifically for high temperature service.

#### Manufacture

- Manufacture.** In order to comply with this specification welded pipe must be manufactured by an automatic welding process using no filler metal, or it must be a seamless pipe. If a welded pipe has a nominal pipe size greater than 14 then it may be constructed from two longitudinal sections, and hence have two longitudinal welds. The pipe may be either hot finished or cold finished.

#### Finish and repair

- Finish.** The surface of the pipe must be clean and free of scale and contaminating iron particles. It can be bright annealed but may be pickled, blasted or can be passivated.
- Repair by welding.** Permitted on  $\leq 20\%$  of the weld seam length of welded pipe if  $\geq \text{NPS } 6$  and having a wall thickness  $\geq 0.200$  in (mm). Tungsten-arc welding process is used for repairs, with filler metal to a grade as specified in A 312 (not repeated here). Weld repairs must be identified on the pipe and in test certificate.

#### Tensile requirements

Grade	UNS	Tensile Strength min		Yield Strength min		Elongation in 2 in (50mm) or 4D min	
		ksi	MPa	ksi	MPa	Longit %	Trans %
<b>All</b>	<b>All</b>	<b>75</b>	<b>515</b>	<b>30</b>	<b>205</b>	<b>35</b>	<b>25</b>
<b>All = All grades listed in the chemical composition table except those listed below</b>							
TP304L	S30403	70	485	25	170	35	25
TP304N	S30451	80	550	35	240	35	25
	S31272	65	450	29	200	35	25
TP316L	S31603	70	485	25	170	35	25
TP316N	S31651	80	550	35	240	35	25
TP321	S32100	75(70 <sup>1</sup> )	515(485 <sup>1</sup> )	30(25 <sup>1</sup> )	205(170 <sup>1</sup> )	35	25
TP321H	S32109	75(70 <sup>1</sup> )	515(485 <sup>1</sup> )	30(25 <sup>1</sup> )	205(170 <sup>1</sup> )	35	25

Notes

1 Values for wall thickness  $> \frac{3}{8}$  in (9.5mm)

# ASTM Pipe

## Pipe Specifications - ASTM A358/A358M

### Electric-fusion-welded austenitic chromium-nickel alloy steel pipe for high-temperature service

This specification covers electric-fusion-welded austenitic chromium-nickel alloy steel pipe suitable for high temperature and general corrosive service.

---

#### Tolerances

- ◊ **Tolerances.** ASTM A530 requirements, apply unless otherwise stated below.
- ◊ **Outside Diameter.**  $\pm 0.5\%$  of specified OD.
- ◊ **Wall Thickness.** Minimum wall thickness shall be  $\leq 0.01$  in (0.3mm) under nominal thickness.
- ◊ **Out-of-Roundness.** Major and minor outside diameters to differ by less than 1%.
- ◊ **Alignment.** The gap between the pipe and a 10 ft (3 m) straight edge shall  $\leq \frac{1}{8}$  in (3mm)

---

#### Finish and repair

- ◊ **Appearance.** Finished pipe will have a workmanlike finish.
- ◊ **Plate Defect Repair by Grinding.** Defects may be repaired by machining or grinding, provided the wall thickness is not reduced below the minimum.
- ◊ **Plate Defect Repair by Welding.** Defects which give unsatisfactory wall thicknesses can be repaired by welding if the purchaser agrees. Repair welds must be suitably NDT examined or lengths pressure tested if repair depth is  $> \frac{1}{4}$  wall thickness.
- ◊ **Finish.** Pipe will be free of scale and contaminating iron particles. Bright annealed pipe need not be pickled, or blasted. The purchaser may request a passivating treatment.



### Tube specifications

ASTM Standards covered in this section	
ASTM Tube – General Requirements	
A450/A450M	General Requirements for Carbon, Ferritic Alloy, and Austenitic Alloy Steel Tubes
A370	Mechanical Testing of Steel Products
A213/A213M	Seamless Ferritic and Austenitic Alloy-Steel Boiler, Superheater and Heat Exchanger and Condenser Tubes
A249/A249M	Welded Austenitic Steel Boiler, Superheater, Heat Exchanger and Condenser Tubes
A268/A268M	Seamless and Welded Ferritic and Martensitic Stainless Steel Tubing for General Service
A269	Seamless and Welded Austenitic Stainless Steel Tubing for General Service
A270	Seamless and Welded Austenitic Stainless Steel Sanitary Tubing
A511	Seamless Stainless Steel Mechanical Tubing
A554	Welded Stainless Steel Mechanical Tubing
A632	Seamless and Welded Austenitic Stainless Steel Tubing (small diameter) for General Service
A778	Welded, Unannealed Austenitic Stainless Steel Tubular Products
A789/A789M	Seamless and Welded Ferritic/Austenitic (Duplex) Stainless Steel Tubing for General Service
A791/A791M	Welded, Unannealed Ferritic Stainless Steel Tubing
A803/A803M	Welded Ferritic Stainless Steel Feedwater Heater Tubes

### Markings on the tube

The full identification should be continuously marked down the whole length, including:

- ◊ Size – Outside Diameter (O/D) and Wall Thickness
- ◊ Specification
- ◊ Grade
- ◊ Method of Manufacture (Seamless or Welded)
- ◊ Heat Number
- ◊ Manufacturer's Name or Symbol

### Hygienic Tubing

Please see separate section on page 6-1.

### Metric ND Tubing

Please see separate section on page 7-1.

### Tube size ranges

An extensive size range is available. Non-standard tube sizes may be subject to mill quantity restrictions and extended delivery times.

Below is a guide to the sizes readily available on an ex-stock basis:

- ◊ Hypodermic tube from 0.4mm to 5mm O/D with wall thickness 0.05mm to 0.4mm
- ◊ Instrumentation tube in straight lengths or continuous coils of up to 1,000 metres long: O/Ds 6mm, 8 mm, 10 mm and 12mm with heavy wall thicknesses, typically 0.5mm, 1mm, 1.5mm or 2mm
- ◊ Metric sizes from 6mm O/D to 610mm O/D with wall thickness 1mm to 6mm
- ◊ Imperial sizes from 1/8" O/D to 6" O/D with wall thickness from 24swg to 10swg
- ◊ Hygienic/Sanitary Tube
  - Imperial sizes to ASTM A270: 1/2", 1", 1 1/2", 2", 2 1/2", 3" & 4" O/D with 16swg wall and 4" O/D with 14swg wall
  - Metric sizes to DIN 11850: 1", 1 1/2", 2", 2 1/2" & 3" O/D with 1.5mm wall and 4" O/D with 2mm wall
- ◊ Welded Tubes for the water industry from 18mm O/D x 1.5mm wall to 910mm O/D x 5mm wall
- ◊ Welded Tube for automotive exhaust systems, mostly in grade 409 – A limited size range from 35mm to 63 mm O/D with wall thickness 1.2mm to 2mm
- ◊ Decorative and structural tubes (welded)
  - Round in metric and imperial O/D sizes from 6mm O/D x 1.0mm wall to 100mm O/D x 3mm wall and 1/8" O/D x 24swg to 4" O/D x 1/4" wall
  - Square in metric and imperial O/D sizes from 12.7 mm O/D x 1.5mm wall to 250mm x 250 x 10mm wall
  - Rectangular in metric sizes from 20mm x 10mm x 1.2mm wall to 300mm x 200mm x 10mm wall
  - Other items include Oval, Handrail and Textured Finish – Most common oval size is 60mm x 33mm x 2.0mm wall
  - Note that most decorative tubes are supplied with a polished finish

# ASTM Tube

## Tube Sizes - General Purpose Seamless Tube

The following table lists tube sizes commonly manufactured to ASTM A269 or ASTM A511. The tables are based on manufacturer's information.

### Imperial dimensions and weights per metre

OD	Wall thickness, in													
	0.020	0.022	0.028	0.035	0.036	0.048	0.064	0.080	0.104	0.125	0.188	0.250	0.375	
in	Weight, kg/m (conventional weights)													
1/8	0.034	0.037	0.044		0.052									
3/16		0.059	0.072		0.088	0.109								
1/4	0.075	0.081	0.101		0.125	0.157	0.193							
5/16			0.129		0.161	0.206	0.258							
3/8			0.157		0.200	0.254	0.323	0.383		0.507				
7/16					0.234		0.390							
1/2			0.214	0.264	0.273	0.352	0.452	0.545		0.760				
5/8					0.344	0.449	0.582	0.714		1.01				
3/4					0.417	0.546	0.712	0.869	1.09	1.27	1.71			
7/8						0.643	0.841	1.03		1.52				
1					0.563	0.741	0.971	1.19	1.51	1.77	2.48	3.04	3.80	
1 1/8						0.838	1.10							
1 1/4						0.944	1.23	1.52		2.28				
1 3/8					0.781		1.36							
1 1/2					0.854		1.49	1.84		2.79	4.00	5.07		
1 5/8							1.62							
1 3/4						1.32	1.75			3.29				
2							2.01			3.80		7.09		
2 1/4										4.31		8.11		
2 1/2							2.53			4.81		9.12		
2 3/4							2.79							
3							3.05	3.79		5.83		11.1		
3 1/2												13.2		
4										7.85		15.2		
5												19.4		
6												23.5		

#### Notes

- Conventional weights are quoted in table above.
- For austenitic and duplex steels multiply the quoted weight by 1.014.
- For ferritic and martensitic steels multiply the quoted weight by 0.985.

### Metric dimensions and weights per metre

OD	Wall thickness, mm						
	0.5	1.0	1.5	2.0	2.5	3.0	4.0
mm	Weight, kg/m (conventional weights)						
6	0.069	0.126	0.170				
8		0.176	0.245				
10		0.226	0.321	0.403			
12		0.277	0.369	0.503			
14			0.462	0.604			
15		0.352	0.510	0.654			
16			0.547	0.705			
18			0.623				
20			0.698	0.888		1.28	
22			0.774	1.02			
25			0.887	1.16	1.43	1.66	
28			1.00	1.31			
30				1.41		2.04	
36				1.66			
38						2.64	3.42
40				1.91			
42				2.01			
50				2.42			

#### Notes

- Conventional weights are quoted in table above.
- For austenitic and duplex steels multiply the quoted weight by 1.014.
- For ferritic and martensitic steels multiply the quoted weight by 0.985.

# ASTM Tube

## Tube Sizes - Heat Exchanger Tube

### Chemical and petrochemical pipe and tube

This heading covers a broad spectrum of industries including chemical, petrochemical, offshore, process, power generation, nuclear, mining and mineral/metal processing, pulp and paper.

- For a full list of Standard Wire Gauge (SWG) and Birmingham Wire Gauge (BWG) dimensions please refer to charts on page 8.2 of this databook.

### Heat exchanger tube - principal SWG sizes

Outside Diameter			Standard Wire Gauge (SWG)							
			22 (0.711mm)	20 (0.914mm)	18 (1.218mm)	16 (1.625mm)	14 (2.032mm)	12 (2.641mm)	11 (2.946mm)	10 (3.251mm)
in	mm	Weight, kg/m (average wall <sup>1</sup> )								
1/4	0.250	6.350	-	0.124	0.157	0.192	-	-	-	-
5/16	0.313	7.950	-	0.161	0.205	0.257	-	-	-	-
3/8	0.375	9.525	-	0.197	0.253	0.321	0.381	-	-	-
1/2	0.500	12.700	0.213	0.270	0.350	0.451	0.543	0.665	0.720	-
5/8	0.625	15.875	0.270	0.342	0.447	0.580	0.704	0.875	0.954	-
3/4	0.750	19.050	-	0.415	0.544	0.709	0.866	1.09	1.19	1.29
7/8	0.875	22.225	0.383	0.488	0.641	0.838	1.03	1.30	1.42	1.55
1	1.000	25.400	0.440	0.560	0.738	0.967	1.19	1.51	1.66	1.80
1 1/4	1.250	31.750	0.553	0.706	0.931	1.23	1.51	1.93	2.13	2.32
1 1/2	1.500	38.100	0.666	0.851	1.13	1.48	1.84	2.35	2.59	2.84
1 3/4	1.750	44.450	0.779	0.996	1.32	1.74	2.16	2.77	3.06	3.35
2	2.000	50.800	0.892	1.14	1.51	2.00	2.48	3.19	3.53	3.87
2 1/2	2.500	63.500	-	-	1.90	2.52	3.13	4.03	4.47	4.91
3	3.000	76.200	-	-	2.29	3.03	3.77	4.87	5.40	5.94
3 1/2	3.500	88.900	-	-	2.67	3.55	4.42	5.70	6.34	6.97
4	4.000	101.60	-	-	3.06	4.07	5.07	6.54	7.28	8.01

#### Notes

<sup>1</sup> Conventional weights are quoted, assuming the tube is specified as average wall.

Add 10% to the weight for minimum wall tube.

Multiply quoted weights by 1.014 for austenitic and duplex steels, by 0.985 for ferritic and martensitic steels.

### Heat exchanger tube - principal BWG sizes

Outside Diameter			Birmingham Wire Gauge (BWG)								
			20 (0.889mm)	18 (1.245mm)	16 (1.651mm)	15 (1.829mm)	14 (2.108mm)	13 (2.413mm)	12 (2.769mm)	11 (3.048mm)	10 (3.403mm)
in	mm	Weight, kg/m (average wall <sup>1</sup> )									
1/4	0.250	6.350	0.12	0.16	0.19	-	-	-	-	-	-
5/16	0.313	7.950	0.15	0.21	0.25	0.28	-	-	-	-	-
3/8	0.375	9.525	0.19	0.25	0.31	0.34	0.39	-	-	-	-
1/2	0.500	12.700	0.25	0.34	0.45	0.49	0.55	0.61	0.68	0.72	-
5/8	0.625	15.875	0.33	0.45	0.58	0.64	0.71	0.80	0.89	0.97	-
3/4	0.750	19.050	0.40	0.55	0.72	0.77	0.88	0.98	1.12	1.20	1.31
7/8	0.875	22.225	0.46	0.64	0.83	0.92	1.04	1.18	1.32	1.44	1.58
1	1.000	25.400	0.54	0.74	0.97	1.06	1.21	1.37	1.55	1.68	1.92
1 1/8	1.125	28.575	0.61	0.83	1.10	1.21	1.37	1.56	1.76	1.92	2.11
1 1/4	1.250	31.750	0.68	0.94	1.23	1.35	1.53	1.76	1.96	2.16	2.40
1 3/8	1.375	34.925	0.74	1.03	1.35	1.49	1.70	1.93	2.19	2.40	2.65
1 1/2	1.500	38.100	0.82	1.13	1.49	1.64	1.87	2.17	2.40	2.63	2.92
1 3/4	1.750	44.450	0.97	1.32	1.74	1.92	2.20	2.50	2.84	3.10	3.44
2	2.000	50.800	-	1.52	1.99	2.20	2.53	2.89	3.27	3.59	3.97
2 1/4	2.250	57.150	-	1.73	2.26	2.48	2.87	3.26	3.70	4.06	4.51
2 3/8	2.375	60.325	-	1.81	2.38	2.63	3.02	3.44	3.93	4.30	4.78
2 1/2	2.500	63.500	-	1.91	2.52	2.78	3.18	3.66	4.14	4.54	5.04
2 7/8	2.875	73.025	-	2.20	2.90	3.20	3.68	4.20	4.79	5.25	5.83
3	3.000	76.200	-	2.31	3.04	3.35	3.85	4.39	5.00	5.49	6.10
3 1/2	3.500	88.900	-	2.69	3.56	3.93	4.51	5.15	5.86	6.44	7.17
4	4.000	101.60	-	-	4.11	4.54	5.21	5.95	6.80	7.47	8.30

Notes

<sup>1</sup> Conventional weights are quoted, assuming the tube is specified as average wall.

Add 10% to the weight for minimum wall tube.

Multiply quoted weights by 1.014 for austenitic and duplex steels, by 0.985 for ferritic and martensitic steels.

# ASTM Tube

## Tube Sizes - Instrumentation Tubing and Capillary Tubing

### Instrumentation and hydraulic control tubing

OD	Wall thickness, mm			
	0.5	1.0	1.5	2.0
mm	Weight, kg/m (conventional weights)			
6	0.069	0.126	0.170	
8		0.176	0.245	
10		0.226	0.321	0.403
12		0.277	0.369	0.503
14			0.462	0.604
15		0.352	0.510	0.654

**Notes**

- Conventional weights are quoted in the table above.
- For austenitic stainless steels multiply the quoted weight by 1.014.
- For ferritic and martensitic steels multiply the quoted weight by 0.985.

### Capillary or hypodermic tubing - typical sizes

Outside Diameter		Wall thickness
in	mm	mm
1/32	0.79	0.20
0.040	1.02	0.20
0.049	1.25	0.20
0.050	1.27	0.20
1/16	1.63	0.15 / 0.20 / 0.25 / 0.30 / 0.40 / 0.51 / 0.56
0.072	1.83	0.23
0.083	2.11	0.25
3/32	2.38	0.15 / 0.20 / 0.30 / 0.40 / 0.51 / 0.91
0.118	3.00	0.30 / 0.50 / 0.70 / 0.90
1/8	3.18	0.20 / 0.25 / 0.51 / 0.81 / 0.91 / 1.22
0.138	3.51	0.40
5/32	3.97	0.25 / 0.40 / 0.56 / 0.71 / 0.91
0.157	4.00	0.70 / 0.90 / 1.00
0.177	4.50	0.50
3/16	4.76	0.13 / 0.20 / 0.25 / 0.40 / 0.46 / 0.51 / 0.56 / 0.71 / 0.81 / 0.91 / 1.22 / 1.63
0.197	5.00	0.50 / 0.75 / 1.00 / 1.50

**Notes**

- When this tubing is used with compression fittings there is a maximum hardness requirement.



## Tube Sizes - Structural and Decorative Tubing

Significant quantities of stainless steel tubing are used for structural and decorative (ornamental) applications. Most of the tubing used in these applications is HF welded, although some TIG welded is also used.

Structural tubing may be specified to ASTM A554, Welded Stainless Steel Mechanical Tubing.

### Square structural and decorative tube - typical sizes

Square size: Outside Dimensions		Wall thickness, mm									
		1.0	1.2	1.5	2.0	3.0	4.0	5.0	6.0	8.0	10.0
mm	in	Weight, kg/m (austenitic stainless steel)									
10.00		0.34									
12.70	1/2	0.37	0.44	0.55							
15.00			0.53	0.65							
20.00		0.60	0.71	0.88	1.19						
22.00			0.79								
25.00			0.92	1.14	1.49	2.20					
25.40	1		0.97	1.10							
30.00			1.10	1.37	1.84	2.72					
32.00	1 1/4		1.20	1.47							
35.00				1.62	2.15						
38.00	1 1/2		1.37	1.75	2.31	3.51					
40.00			1.49	1.85	2.45	3.75	4.80				
50.00				2.32	3.08	4.65	5.96	7.41			
60.00				2.80	3.71	5.49	7.22	8.90			
70.00					4.38	6.53	8.45	10.6			
80.00					4.98	7.53	9.81	12.3			
100.00	4				6.40	9.53	12.4	15.3	17.5	21.6	
120.00						11.8	14.7	18.0			36.0
150.00						14.0	18.6	23.0	31.2	34.3	41.7
200.00						19.1	24.8	30.8	35.0	47.3	57.6
250.00								37.1		59.9	73.5

#### Notes

- This table is based on manufacturer's data.
- For ferritic and martensitic steel multiply the quoted austenitic steel weight by 0.97.

# ASTM Tube

## Tube Sizes - Structural and Decorative Tubing

### Rectangular structural and decorative tube - typical sizes

Size: Outside Dimensions	Wall thickness, mm									
	1.0	1.2	1.5	2.0	3.0	4.0	5.0	6.0	8.0	10.0
mm	Weight, kg/m (austenitic stainless steel)									
20 x 10	0.30	0.35	0.44							
25 x 10			0.59							
25 x 15		0.72	0.90							
30 x 10		0.71	0.90							
30 x 15		0.82	0.76							
30 x 20		0.92	1.14	1.49						
40 x 15		1.01	1.25							
40 x 20		1.10	1.37	1.84						
40 x 30			1.61	2.13						
50 x 25		1.41	1.75	2.31						
50 x 30			1.85		3.61					
50 x 40					4.08					
60 x 20			1.85	2.45						
60 x 30				2.80	4.13					
60 x 40			2.32	3.08	4.65	5.60				
70 x 40				3.40						
80 x 40			2.80	3.71	5.49	7.22	8.94			
80 x 60				4.38	6.53					
100 x 40			3.29		6.53					
100 x 50				4.68	6.95	9.09	11.3			
100 x 60				4.98	7.53	9.81	12.3			
120 x 40				4.98	7.53					
120 x 60				5.64	8.12	11.1	13.8			
120 x 80					9.53	12.4	15.4	17.3		
150 x 50					9.53					
150 x 80					10.7					
150 x 100					11.7	15.4	18.8	22.6	27.9	
200 x 100					14.06	18.5	22.6	27.1	34.3	41.7
200 x 150								31.6	41.3	
250 x 150								36.9	47.3	
300 x 100									47.3	

**Notes**

- This table is based on manufacturer's data.
- For ferritic and martensitic steel multiply the quoted austenitic steel weight by 0.97.

## Tube Sizes - Structural and Decorative Tubing

### Round structural and decorative tube - typical sizes

Outside Diameter (OD)		Wall thickness, mm						
		1.0	1.2	1.5	2.0	2.5	3.0	4.0
mm	in	Weight, kg/m (austenitic stainless steel)						
12.70	1/2	0.29	0.35	0.42	0.54	0.64	0.73	-
14.00		0.33	0.39	0.47	0.60	0.72	0.83	-
15.00		0.35	0.42	0.51	0.65	0.78	0.90	-
15.88	5/8	0.37	0.44	0.54	0.70	0.84	0.97	-
16.00		0.38	0.45	0.55	0.70	0.85	0.98	1.20
18.00		0.43	0.51	0.62	0.80	0.97	1.13	1.40
19.05	3/4	0.45	0.54	0.66	0.85	1.04	1.21	1.51
20.00		0.48	0.57	0.70	0.90	1.10	1.28	1.60
22.00		0.53	0.63	0.77	1.00	1.22	1.43	1.80
22.22	7/8	0.53	0.63	0.78	1.01	1.23	1.44	1.83
23.00		0.55	0.66	0.81	1.05	1.28	1.50	1.90
25.00		0.60	0.72	0.88	1.15	1.41	1.65	2.10
25.40	1	0.61	0.73	0.90	1.17	1.43	1.68	2.14
28.00		0.68	0.81	1.00	1.30	1.60	1.88	2.40
28.57	1 1/8	0.69	0.82	1.02	1.33	1.63	1.92	2.46
30.00		0.73	0.87	1.07	1.40	1.72	2.03	2.60
31.75	1 1/4	0.77	0.92	1.14	1.49	1.83	2.16	2.78
32.00		0.78	0.92	1.15	1.50	1.85	2.18	2.80
34.00		0.83	0.99	1.22	1.60	1.97	2.33	3.00
35.00		0.85	1.02	1.26	1.65	2.03	2.40	3.10
38.10	1 1/2	0.93	1.11	1.37	1.81	2.23	2.64	3.42
40.00		0.98	1.17	1.45	1.90	2.35	2.78	3.61
42.00		1.03	1.23	1.52	2.00	2.47	2.93	3.81
44.45	1 3/4	1.09	1.30	1.61	2.13	2.63	3.11	4.05
45.00		1.10	1.32	1.63	2.15	2.66	3.15	4.11
48.30		1.18	1.42	1.76	2.32	2.87	3.40	4.44
50.00		1.23	1.47	1.82	2.40	2.97	3.53	4.61
50.80	2	1.25	1.49	1.85	2.44	3.02	3.59	4.69
51.00		1.25	1.50	1.86	2.45	3.04	3.61	4.71
53.00		1.30	1.56	1.93	2.55	3.16	3.76	4.91
54.00		1.33	1.59	1.97	2.60	3.22	3.83	5.01
55.00		1.35	1.62	2.01	2.65	3.29	3.91	5.11
58.00		1.43	1.71	2.12	2.80	3.47	4.13	5.40
60.00		1.48	1.77	2.20	2.90	3.60	4.30	5.60
63.50	2 1/2	1.56	1.87	2.33	3.08	3.82	4.50	6.00
65.00		1.60	1.92	2.38	3.15	3.90	4.70	6.10
70.00		1.73	2.07	2.57	3.41	4.20	5.00	6.60
76.10	3	1.88	2.25	2.80	3.70	4.60	5.50	7.20
80.00		1.98	2.37	2.95	3.90	4.90	5.80	7.60
85.00		2.10	2.52	3.10	4.20	5.20	6.20	8.10
101.60	4	-	3.02	3.80	5.00	6.20	7.40	9.80

Notes

- For ferritic and martensitic steel multiply the quoted austenitic steel weight by 0.97.

# ASTM Tube

## Chemical Compositions and Dimensional Tolerances

### Chemical compositions

See ASTM A240/240M on page 1-6 of this Databook.

### Standard tolerances for welded and seamless cold finished tube (ASTM A450/A450M)

(OD)		Variations in OD <sup>1</sup>				Variation in $t_{min}$ <sup>2</sup>	
		Under		Over		Under	Over
in	mm	in	mm	in	mm	%	%
<1	<25.4	0.004	0.1	0.004	0.1	0	20
1	25.4	0.006	0.15	0.006	0.1	0	20
>1 to 1½	>25.4 to 38.1	0.006	0.15	0.006	0.15	0	20
>1½ to <2	>38.1 to <50.8	0.008	0.2	0.008	0.2	0	22
2	50.8	0.008	0.2	0.008	0.2	0	22
>2 to 2½	>50.8 to 63.5	0.010	0.25	0.010	0.25	0	22
>2½ to 3	>63.5 to 76.2	0.012	0.3	0.012	0.3	0	22
>3 to 4	>76.2 to 101.6	0.015	0.38	0.015	0.38	0	22

### Standard tolerances for seamless hot finished tube (ASTM A450/A450M)

Outside Diameter (OD)		Wall Thickness (t)		Variations in OD <sup>1</sup>				Variation in $t_{min}$ <sup>2</sup>	
				Under		Over		Under	Over
in	mm	in	mm	in	mm	in	mm	%	%
≤4	≤101.6	≤0.095	≤2.4	1/32	0.8	1/64	0.4	0	40
≤4	≤101.6	>0.095 to 0.150	>2.4 to 3.8	1/32	0.8	1/64	0.4	0	35
≤4	≤101.6	>0.150 to 0.180	>3.8 to 4.6	1/32	0.8	1/64	0.4	0	33
≤4	≤101.6	>0.180	>4.6	1/32	0.8	1/64	0.4	0	28
>4 to 7½	>101.6 to 190.5	>0.095	>2.4	3/64	1.2	1/64	0.4	-	-
>4 to 7½	>101.6 to 190.5	>0.095 to 0.150	>2.4 to 3.8	3/64	1.2	1/64	0.4	0	35
>4 to 7½	>101.6 to 190.5	>0.150 to 0.180	>3.8 to 4.6	3/64	1.2	1/64	0.4	0	33
>4 to 7½	>101.6 to 190.5	>0.180	>4.6	3/64	1.2	1/64	0.4	0	28
>7½ to 9	>190.5 to 228.6	≤0.095	≤2.4	1/16	1.6	1/64	0.4	-	-
>7½ to 9	>190.5 to 228.6	>0.095 to 0.150	>2.4 to 3.8	1/16	1.6	1/64	0.4	0	35
>7½ to 9	>190.5 to 228.6	>0.150 to 0.180	>3.8 to 4.6	1/16	1.6	1/64	0.4	0	33
>7½ to 9	>190.5 to 228.6	>0.180	>4.6	1/16	1.6	1/64	0.4	0	28

**Notes**

1 Includes ovality tolerance except for thin wall tube.

2  $t_{min}$  = minimum wall thickness.

- ◊ **Standard Cut Lengths.** Alternatives are: Random As agreed with the purchaser.  
Specified Cut lengths as specified, with end finish specified also.
- ◊ **Length tolerances.** No tube shall be shorter than specified. Over length tolerances of tubes (before bending) are as follows: Seamless, hot finished tube: All sizes: 3/16 in (5mm) max.  
Seamless, cold finished and welded tube: <2 in (50.8mm) OD: 1/8 in (3mm) max.  
≥2 in (50.8mm) OD: 3/16 in (5mm) max.  
These apply to lengths <24 ft (7.3 m) and are increased by 1/8 in (3mm) for each additional 10 ft (3 m).

### Seamless ferritic and austenitic alloy-steel boiler, superheater and heat exchanger tubes

This specification covers minimum wall thickness seamless ferritic and austenitic steel, boiler and superheater tubes and austenitic steel heat exchanger tubes.

#### Finish

- Finish. Austenitic grades are pickled free of scale. Bright annealed tube need not be pickled. Ferritic cold drawn tubes shall be free of scale, but slight oxidation is allowed. Ferritic hot formed tubes shall be free of loose scale.

#### Tensile and hardness requirements

Grade	UNS	Tensile Strength min		Yield Strength min		<sup>1</sup> Elongation in 2 in (50 mm) or 4D, min	Brinell Hardness HB max	Vickers Hardness HV max	Rockwell Hardness HRB or C scale/max
		ksi	MPa	ksi	MPa				
18Cr-2Mo		60	415	40	275	201	217	230	B96
TP201	S20100	95	655	38	260	35	219	230	B95
TP202	S20200	90	620	45	310	35	219	230	B95
TP304	S30400	75	515	30	205	35	192	200	B90
TP304H	S30409	75	515	30	205	35	192	200	B90
TP304N	S30451	80	550	35	240	35	192	200	B90
TP304L	S30403	70	485	25	170	35	192	200	B90
TP304LN	S30453	75	515	30	205	35	192	200	B90
TP309Cb	S30940	75	515	30	205	35	192	200	B90
TP309H	S30909	75	515	30	205	35	192	200	B90
TP309HCb	S30941	75	515	30	205	35	192	200	B90
TP309S	S30908	75	515	30	205	35	192	200	B90
TP310Cb	S31040	75	515	30	205	35	192	200	B90
TP310H	S31009	75	515	30	205	35	192	200	B90
TP310HCb	S31041	75	515	30	205	35	192	200	B90
TP310HCbN	S31042	95	655	43	295	30	256	- <sup>3</sup>	B100
TP310S	S31008	75	515	30	205	35	192	200	B90
	S31272	65	450	29	200	35	217	- <sup>3</sup>	B95
TP316	S31600	75	515	30	205	35	192	200	B90
TP316H	S31609	75	515	30	205	35	192	200	B90
TP316L	S31603	70	485	25	170	35	192	200	B90
TP316N	S31651	80	550	35	240	35	192	200	B90
TP316LN	S31653	75	515	30	205	35	192	200	B90
TP317	S31700	75	515	30	205	35	192	200	B90
TP317L	S31703	75	515	30	205	35	192	200	B90
TP321	S32100	75	515	30	205	35	192	200	B90
TP321H	S32109	75	515	30	205	35	192	200	B90
TP347	S34700	75	515	30	205	35	192	200	B90
TP347H	S34709	75	515	30	205	35	192	200	B90
TP347LN	S34751	75	515	30	205	35	192	200	B90
TP347HFG		80	550	30	205	35	192	200	B90
TP348	S34800	75	515	30	205	35	192	200	B90
TP348H	S34809	75	515	30	205	35	192	200	B90
XM-15	S38100	75	515	30	205	35	192	200	B90
XM-19	S20910	100	690	55	380	35	250	265	C25
	S30615	90	620	40	275	35	192	200	B90
	S30815	87	600	45	310	40	217	- <sup>3</sup>	B95
	S31050	84 (78 <sup>2</sup> )	580 (540 <sup>2</sup> )	39 (37 <sup>2</sup> )	270 (255 <sup>2</sup> )	25	217	- <sup>3</sup>	B95
	S33228	73	500	27	185	30	192	200	B90
	S21500	78	540	33	230	35	192	200	B90
	S31725	75	515	30	205	35	192	200	B90
	S31726	80	550	35	240	35	192	200	B90
	S32615	80	550	32	220	25	192	200	B90
	S25700	78	540	35	240	50	192	200	B90

#### Notes

- Elongation for wall thickness  $t = \frac{5}{16}$  in (8mm); For wall thickness  $t < \frac{5}{16}$  in (8mm): Elongation % =  $32t + 10.00$  (=  $1.25t + 10.00$ ) for 18Cr-2Mo. Calculated elongation values should be rounded to the nearest whole number.
- Values if wall thickness  $t > 0.25$  in
- No Vickers hardness provided.

# ASTM Tube

## Tube Specifications - ASTM A249/A249M

### Welded austenitic steel boiler, superheater, heat exchanger and condenser tubes

This specification covers nominal wall thickness austenitic steel welded tubes for use as boiler, superheater, heat exchanger, condenser, or hygienic tubes. Minimum wall thickness tube may be also specified.

### Tensile and hardness requirements

Grade	UNS	Tensile Strength min		Yield Strength min		Elongation in 2 in (50 mm) or 4D, min	Rockwell Hardness HRB or C
		ksi	MPa	ksi	MPa		
TP201	S20100	95	655	38	260	35	B95
TP202	S20200	90	620	38	260	35	B95
TP304	S30400	75	515	30	205	35	B90
TP304H	S30409	75	515	30	205	35	B90
TP304N	S30451	80	550	35	240	35	B90
TP304L	S30403	70	485	25	170	35	B90
TP304LN	S30453	75	515	30	205	35	B90
TP305	S30500	75	515	30	205	35	B90
TP309Cb	S30940	75	515	30	205	35	B90
TP309H	S30909	75	515	30	205	35	B90
TP309HCb	S30941	75	515	30	205	35	B90
TP309S	S30908	75	515	20	205	35	B90
TP310Cb	S31040	75	515	30	205	35	B90
TP310H	S31009	75	515	30	205	35	B90
TP310HCb	S31041	75	515	30	205	35	B90
TP310S	S31008	75	515	30	205	35	B90
TP316	S31600	75	515	30	205	35	B90
TP316H	S31609	75	515	30	205	35	B90
TP316L	S31603	70	485	25	170	35	B90
TP316N	S31651	80	550	35	240	35	B90
TP316LN	S31653	75	515	30	205	35	B90
TP317	S31700	75	515	30	205	35	B90
TP317L	S31703	75	515	30	205	35	B90
TP321	S32100	75	515	30	205	35	B90
TP321H	S32109	75	515	30	205	35	B90
TP347	S34700	75	515	30	205	35	B90
TP347H	S34709	75	515	30	205	35	B90
TP348	S34800	75	515	30	205	35	B90
TP348H	S34809	75	515	30	205	35	B90
TPXM-15	S38100	75	515	30	205	35	B90
TPXM-19	S20910	100	690	55	380	35	C25
TPXM-29	S24000	100	690	55	380	35	B100
	S30615	90	620	40	275	35	B95
	S31050	84 (78 <sup>1</sup> )	580 (540 <sup>1</sup> )	39 (37 <sup>1</sup> )	270 (255 <sup>1</sup> )	25	B95
	S31254	94	650	44	300	35	B96
	S30815	87	600	45	310	35	B95
	S31725	75	515	30	205	35	B90
	S31726	80	550	35	240	35	B90
	S24565	115	795	60	415	35	B100
	S33228	73	500	27	185	30	B90
	S30415	87	600	42	290	35	B96
	S32654	109	750	62	430	35	B100
	N08367	100 (95 <sup>2</sup> )	690 (655 <sup>2</sup> )	45 (45 <sup>2</sup> )	310 (310 <sup>2</sup> )	30	B100
	N08904	71	490	31	215	35	B90
	N08926	94	650	43	295	35	B100

Notes

- 1 Values if wall thickness  $t > 0.25$  in
- 2 Values if wall thickness  $t > 0.187$  in
- Refer to mandatory testing exceptions also.



### Seamless and welded austenitic stainless steel tubing for general service

This specification covers nominal wall thickness austenitic stainless steel tubing for general corrosion resisting and low or high temperature service.

#### Tolerances

- Cut Length.** No tube may be shorter than specified. For tube  $<1\frac{1}{2}$  in (38.1mm) cut length may be up to  $\frac{1}{8}$  in (3 mm) longer than specified. For tube  $\geq 1\frac{1}{2}$  in (38.1mm) cut length may be up to  $\frac{3}{16}$  in (4.8mm) longer than specified. These tolerances are increased by  $\frac{1}{8}$  in (3mm) for every 10 ft (3 m) over 24 ft (7.3 m), up to a maximum tolerance of  $\frac{1}{2}$  in (13mm).

#### Cross-sectional tolerances

Outside Diameter (OD)		Wall Thickness (t)		Variations in OD				Variation in t	
in	mm	in	mm	Under		Over		Under	Over
				in	mm	in	mm	%	%
$<1\frac{1}{2}$	$<12.7$	All	All	0.005	0.13	0.005	0.13	15	15
$1\frac{1}{2}$ to $<1\frac{1}{2}$	12.7 to $<38.1$	$\geq 0.065$	$\geq 1.6$	0.005	0.13	0.005	0.13	10	10
$1\frac{1}{2}$ to $<1\frac{1}{2}$	12.7 to $<38.1$	$<0.065^1$	$<1.6^1$	0.005	0.13	0.005	0.13	10	10
$1\frac{1}{2}$ to $<3\frac{1}{2}$	38.1 to $<88.9$	$\geq 0.095$	$\geq 2.4$	0.010	0.25	0.010	0.25	10	10
$1\frac{1}{2}$ to $<3\frac{1}{2}$	38.1 to $<88.9$	$<0.095^1$	$<2.4^1$	0.010	0.25	0.010	0.25	10	10
$3\frac{1}{2}$ to $<5\frac{1}{2}$	88.9 to $<139.7$	$\geq 0.150$	$\geq 3.8$	0.015	0.38	0.015	0.38	10	10
$3\frac{1}{2}$ to $<5\frac{1}{2}$	88.9 to $<139.7$	$<0.150^1$	$<3.8^1$	0.015	0.38	0.015	0.38	10	10
$5\frac{1}{2}$ to $\leq 8$	139.1 to $\leq 203.2$	$\geq 0.150$	$\geq 3.8$	0.030	0.76	0.030	0.76	10	10
$5\frac{1}{2}$ to $\leq 8$	139.1 to $\leq 203.2$	$<0.150^1$	$<3.8^1$	0.030	0.76	0.030	0.76	10	10

Notes

1 Thin walled tubes. Therefore ovality tolerance increases, but mean OD at a cross section must be within permissible variation.

#### Finish

- Finish.** Tubes to be pickled, free of scale. Where bright annealed, pickling is not necessary.

# Butt Weld Fittings

## Introduction

**Butt Weld Fittings are a family of fittings used for forming circumferential butt weld joints in pipework systems.**

**They are used only in conjunction with ANSI Pipe and are available in the same size range. They are used in areas where pipe-work is permanent and are designed to provide good flow characteristics.**

### Manufacture

- ◉ **Materials.** Refer to chemical composition table ASTM A240 on page 1-6. Fittings may be made from forgings, bars, plates, or seamless or welded tubular products, provided the materials conform to the chemical composition table.
- ◉ **The steel** may be melted by electric-furnace, or vacuum-furnace, or by either of these followed by vacuum or electroslag-consumable remelting.
- ◉ **Forming.** Fittings may be formed by hammering, pressing, piercing, extruding, upsetting, rolling, bending, fusion welding, machining or any combination of these processes.
- ◉ **Heat Treatment.** All fittings are heat treated in accordance with the heat treatment table. All welding must be done prior to heat treatment.

### Manufacturing standards

Wrought pipe fittings are manufactured to dimensions and tolerances in ANSI B16.9 with the exception of short radius elbows and return bends which are made to ANSI B16.28. Light-weight corrosion resistant fittings are made to MSS SP43.

Butt Weld Fittings are available to ASTM A403, ASTM A815 and MSS SP43. These standards require the fittings to be manufactured as follows:

- ◉ Seamless austenitic fittings are made from seamless pipe to ASTM A312.
- ◉ Welded fittings in austenitic grades are manufactured from welded pipe to ASTM A312 or plate to ASTM A240. Note that welded fittings manufactured from plate may have two-welds.
- ◉ Duplex (ferritic/austenitic) grades are manufactured from pipe to ASTM A790 or plate to ASTM A240.

ASTM A403/A815 Butt Weld Fittings are sub-divided into four classes:

- ◉ **WP-S:** Made from seamless pipe to ASTM A312 (Austenitic) or ASTM A790 (Duplex).
- ◉ **WP-W:** Manufactured from welded pipe to ASTM A312 (Austenitic) or ASTM A790 (Duplex). There is no requirement for radiography unless a manufacturer's weld has been introduced or there are welds made with the addition of filler metal.
- ◉ **WP-WX:** Of welded construction. All welds must be 100% radiographed in accordance with Paragraph UW-51 of Section VIII, Division 1 of the ASME Boiler and Pressure Vessel Code.
- ◉ **WP-WU:** Of welded construction. All welds must be 100% examined ultrasonically in accordance with Paragraph UW-51 of Section VIII, Division 1 of the ASME Boiler and Pressure Vessel Code. Note that this Class only applies to austenitic fittings made to ASTM A403.

**CR Fittings** are manufactured to the requirements of MSS SP43. These are light-weight fittings and do not require radiography.

Notes:  
WP: Means Wrought Pipe  
CR: Means Corrosion Resistant

### Markings on tube and fittings

The full identification of the fitting should be marked on it including:

- ◉ Nominal Pipe Size (Nominal Bore)
- ◉ Schedule (Wall Thickness)
- ◉ Specification
- ◉ Grade
- ◉ Method of Manufacture (Seamless or Welded)
- ◉ Heat Number
- ◉ Manufacturer's Name or Symbol

# Butt Weld Fittings

## Range/Sizes - 90° and 45° Long Radius Elbows - ANSI B16.9

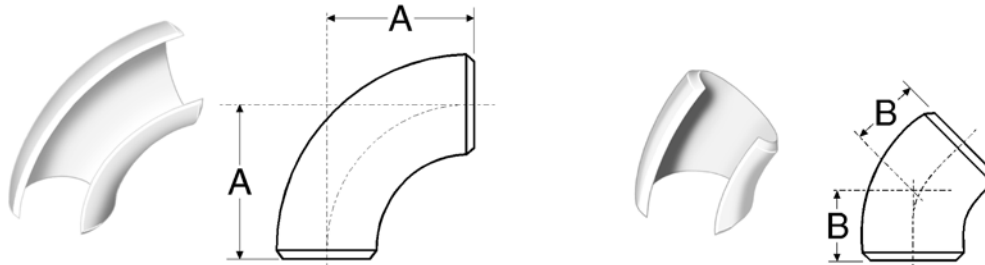

### Dimensions (based on ASME/ANSI B16.9) and example weights for long radius elbows

Nominal Pipe Size	Common		90° Elbow			45° Elbow		
	OD at Bevel		A		40S/STD <sup>1</sup>	B		40S/STD <sup>1</sup>
	in	mm	in	mm	kg/piece	in	mm	kg/piece
1/2	0.84	21	1.50	38	0.08	0.62	16	0.04
3/4	1.05	27	1.50	38	0.10	0.75	19	0.05
1	1.32	33	1.50	38	0.15	0.88	22	0.07
1 1/4	1.66	42	1.88	48	0.25	1.00	25	0.12
1 1/2	1.90	48	2.25	57	0.36	1.12	29	0.18
2	2.38	60	3.00	76	0.65	1.38	35	0.32
2 1/2	2.88	73	3.75	95	1.29	1.75	44	0.64
3	3.50	89	4.50	114	2.02	2.00	51	1.01
3 1/2	4.00	102	5.25	133	2.83	2.25	57	1.41
4	4.50	114	6.00	152	3.84	2.50	64	1.92
5	5.56	141	7.50	190	6.51	3.12	79	3.25
6	6.62	168	9.00	229	10.1	3.75	95	5.05
8	8.62	219	12.00	305	20.3	5.00	127	10.15
10	10.75	273	15.00	381	36.0	6.25	159	18.0
12	12.75	324	18.00	457	53.0	7.50	190	26.5
14	14.00	356	21.00	533	68.0	8.75	222	34.0
16	16.00	406	24.00	610	89.2	10.00	254	44.6
18	18.00	457	27.00	686	113.0	11.25	286	56.5
20	20.00	508	30.00	762	140.0	12.50	318	70.0
22	22.00	559	33.00	838	170.0	13.50	343	85.0
24	24.00	610	36.00	914	202.0	15.00	381	101.0
26	26.00	660	39.00	991	241.4	16.00	406	120.5
28	28.00	711	42.00	1067	279.9	17.25	438	140.0
30	30.00	762	45.00	1143	321.3	18.50	470	160.5
32	32.00	813	48.00	1219	365.6	19.75	502	183.0
34	34.00	864	51.00	1295	-	21.00	533	-
36	36.00	914	54.00	1372	462.7	22.25	565	231.0
38	38.00	965	57.00	1448	-	23.62	600	-
40	40.00	1016	60.00	1524	571.3	24.88	632	285.5
42	42.00	1067	63.00	1600	629.8	26.00	660	315.0
44	44.00	1118	66.00	1676	-	27.38	695	-
46	46.00	1168	69.00	1753	-	28.62	727	-
48	48.00	1219	72.00	1829	-	29.88	759	-

**Notes**

- Dimensions quoted in mm are 'Nominal' values from B16.9 (i.e. rounded equivalents of the inch dimensions). Refer to ASME/ANSI B16.9 for additional 'Max' and 'Min' metric dimensions.
- For tolerances see page 3-14.
- <sup>1</sup> Weights are approximate and based on manufacturers' data (where available) for Schedule 40S/Standard fittings. See page 3-15 for further information.

# Butt Weld Fittings

## Range/Sizes - Equal Tees - ANSI B16.9

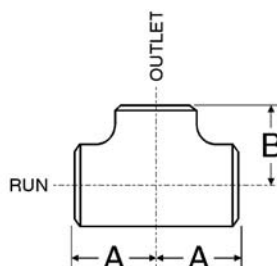
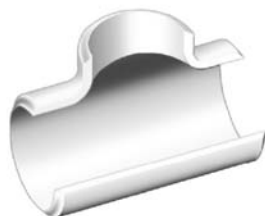

### Dimensions (based on ASME/ANSI B16.9) and example weights for equal tees

Nominal Pipe Size	OD at Bevelled		Run		Outlet		Weight (Tees only)
	OD		A		B		40S/STD <sup>1</sup>
	in	mm	in	mm	in	mm	kg/piece
1/2	0.84	21	1.00	25	1.00	25	0.08
3/4	1.05	27	1.12	29	1.12	29	0.11
1	1.32	33	1.50	38	1.50	38	0.24
1 1/4	1.66	42	1.88	48	1.88	48	0.41
1 1/2	1.90	48	2.25	57	2.25	57	0.60
2	2.38	60	2.50	64	2.50	64	0.87
2 1/2	2.88	73	3.00	76	3.00	76	1.66
3	3.50	89	3.38	86	3.38	86	1.90
3 1/2	4.00	102	3.75	95	3.75	95	-
4	4.50	114	4.12	105	4.12	105	4.13
5	5.56	141	4.88	124	4.88	124	6.55
6	6.62	168	5.62	143	5.62	143	9.73
8	8.62	219	7.00	178	7.00	178	18.0
10	10.75	273	8.50	216	8.50	216	30.8
12	12.75	324	10.00	254	10.00	254	44.3
14	14.00	356	11.00	279	11.00	279	53.7
16	16.00	406	12.00	305	12.00	305	66.3
18	18.00	457	13.50	343	13.50	343	84.1
20	20.00	508	15.00	381	15.00	381	104
22	22.00	559	16.50	419	16.50	419	126
24	24.00	610	17.00	432	17.00	432	140
26	26.00	660	19.50	495	19.50	495	158
28	28.00	711	20.50	521	20.50	521	176
30	30.00	762	22.00	559	22.00	559	203
32	32.00	813	23.50	597	23.50	597	231
34	34.00	864	25.00	635	25.00	635	-
36	36.00	914	26.50	673	26.50	673	294
38	38.00	965	28.00	711	28.00	711	-
40	40.00	1016	29.50	749	29.50	749	363
42	42.00	1067	30.00	762	28.00	711	382
44	44.00	1118	32.00	813	30.00	762	-
46	46.00	1168	33.50	851	31.50	800	-
48	48.00	1219	35.00	889	33.00	838	-

#### Notes

- For NPS 26 and larger: Dimensions are not applicable to crosses. Also, dimension B is recommended but not required.
- Dimensions quoted in mm are 'Nominal' values from B16.9 (i.e. rounded equivalents of the inch dimensions). Refer to B16.9 for additional 'Max' and 'Min' metric dimensions.
- For tolerances see page 3-14.
- <sup>1</sup> Weights are approximate and based on manufacturers' data (where available) for Schedule 40S/Standard fittings. See page 3-15 for further information.

# Butt Weld Fittings

## Range/Sizes - Reducing Tees - ANSI B16.9

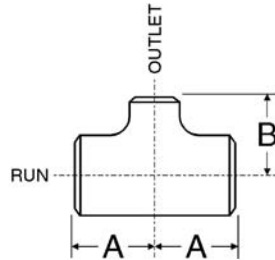
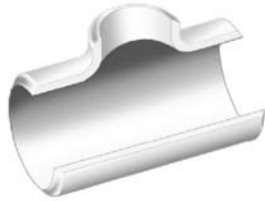

Nominal Pipe Size	Run OD		Outlet OD		Run		Outlet		Weight
	OD at Bevel		OD at Bevel		A		B		40S/STD <sup>1</sup>
	in	mm	in	mm	in	mm	in	mm	kg/piece
1/2⇨3/8	0.84	21	0.68	17	1.00	25	1.00	25	-
1/2⇨1/4	0.84	21	0.54	14	1.00	25	1.00	25	-
3/4⇨1/2	1.05	27	0.84	21	1.12	29	1.12	29	0.12
3/4⇨3/8	1.05	27	0.68	17	1.12	29	1.12	29	-
1⇨3/4	1.32	33	1.05	27	1.50	38	1.50	38	0.23
1⇨1/2	1.32	33	0.84	21	1.50	38	1.50	38	0.22
1 1/4⇨1	1.66	42	1.32	33	1.88	48	1.88	48	0.39
1 1/4⇨3/4	1.66	42	1.05	27	1.88	48	1.88	48	0.37
1 1/4⇨1/2	1.66	42	0.84	21	1.88	48	1.88	48	-
1 1/2⇨1 1/4	1.90	48	1.66	42	2.25	57	2.25	57	0.57
1 1/2⇨1	1.90	48	1.32	33	2.25	57	2.25	57	0.55
1 1/2⇨3/4	1.90	48	1.05	27	2.25	57	2.25	57	0.52
1 1/2⇨1/2	1.90	48	0.84	21	2.25	57	2.25	57	0.51
2⇨1 1/2	2.38	60	1.90	48	2.50	64	2.38	60	0.83
2⇨1 1/4	2.38	60	1.66	42	2.50	64	2.25	57	0.80
2⇨1	2.38	60	1.32	33	2.50	64	2.00	51	0.74
2⇨3/4	2.38	60	1.05	27	2.50	64	1.75	44	-
2 1/2⇨2	2.88	73	2.38	60	3.00	76	2.75	70	1.53
2 1/2⇨1 1/2	2.88	73	1.90	48	3.00	76	2.62	67	1.49
2 1/2⇨1 1/4	2.88	73	1.66	42	3.00	76	2.50	64	1.38
2 1/2⇨1	2.88	73	1.32	33	3.00	76	2.25	57	-
3⇨2 1/2	3.50	89	2.88	73	3.38	86	3.25	83	2.29
3⇨2	3.50	89	2.38	60	3.38	86	3.00	76	2.16
3⇨1 1/2	3.50	89	1.90	48	3.38	86	2.88	73	2.05
3⇨1 1/4	3.50	89	1.66	42	3.38	86	2.75	70	-
3 1/2⇨3	4.00	102	3.50	89	3.75	95	3.62	92	-
3 1/2⇨2 1/2	4.00	102	2.88	73	3.75	95	3.50	89	-
3 1/2⇨2	4.00	102	2.38	60	3.75	95	3.25	83	-
3 1/2⇨1 1/2	4.00	102	1.90	48	3.75	95	3.12	79	-
4⇨3 1/2	4.50	114	4.00	102	4.12	105	4.00	102	-
4⇨3	4.50	114	3.50	89	4.12	105	3.88	98	3.83
4⇨2 1/2	4.50	114	2.88	73	4.12	105	3.75	95	3.70
4⇨2	4.50	114	2.38	60	4.12	105	3.50	89	3.52
4⇨1 1/2	4.50	114	1.90	48	4.12	105	3.38	86	3.41
5⇨4	5.56	141	4.50	114	4.88	124	4.62	117	6.14
5⇨3 1/2	5.56	141	4.00	102	4.88	124	4.50	114	-
5⇨3	5.56	141	3.50	89	4.88	124	4.38	111	5.85
5⇨2 1/2	5.56	141	2.88	73	4.88	124	4.25	108	5.71
5⇨2	5.56	141	2.38	60	4.88	124	4.12	105	-
6⇨5	6.62	168	5.56	141	5.62	143	5.38	137	9.21
6⇨4	6.62	168	4.50	114	5.62	143	5.12	130	8.81
6⇨3 1/2	6.62	168	4.00	102	5.62	143	5.00	127	-
6⇨3	6.62	168	3.50	89	5.62	143	4.88	124	8.52
6⇨2 1/2	6.62	168	2.88	73	5.62	143	4.75	121	-
8⇨6	8.62	219	6.62	168	7.00	178	6.62	168	16.8
8⇨5	8.62	219	5.56	141	7.00	178	6.38	162	16.3
8⇨4	8.62	219	4.50	114	7.00	178	6.12	156	15.9

# Butt Weld Fittings

## Range/Sizes - Reducing Tees - ANSI B16.9

Nominal Pipe Size	Run OD		Outlet OD		Run		Outlet		Weight
	OD at Bevel		OD at Bevel		A		B		40S/STD <sup>1</sup>
	in	mm	in	mm	in	mm	in	mm	kg/piece
8⇒3½	8.62	219	4.00	102	7.00	178	6.00	152	-
10⇒8	10.75	273	8.62	219	8.50	216	8.00	203	28.9
10⇒6	10.75	273	6.62	168	8.50	216	7.62	194	27.6
10⇒5	10.75	273	5.56	141	8.50	216	7.50	191	27.1
10⇒4	10.75	273	4.50	114	8.50	216	7.25	184	-
12⇒10	12.75	324	10.75	273	10.00	254	9.50	241	42.3
12⇒8	12.75	324	8.62	219	10.00	254	9.00	229	40.3
12⇒6	12.75	324	6.62	168	10.00	254	8.62	219	39.1
12⇒5	12.75	324	5.56	141	10.00	254	8.50	216	-
14⇒12	14.00	356	12.75	324	11.00	279	10.62	270	52.2
14⇒10	14.00	356	10.75	273	11.00	279	10.12	257	50.2
14⇒8	14.00	356	8.625	219	11.00	279	9.75	248	48.4
14⇒6	14.00	356	6.62	168	11.00	279	9.38	238	-
16⇒14	16.00	406	14.00	356	12.00	305	12.00	305	65.1
16⇒12	16.00	406	12.75	324	12.00	305	11.62	295	63.6
16⇒10	16.00	406	10.75	273	12.00	305	11.12	283	61.6
16⇒8	16.00	406	8.62	219	12.00	305	10.75	273	-
16⇒6	16.00	406	6.62	168	12.00	305	10.38	264	-
18⇒16	18.00	457	16.00	406	13.50	343	13.00	330	81.5
18⇒14	18.00	457	14.00	356	13.50	343	13.00	330	80.3
18⇒12	18.00	457	12.75	324	13.50	343	12.62	321	78.9
18⇒10	18.00	457	10.75	273	13.50	343	12.12	308	-
18⇒8	18.00	457	8.62	219	13.50	343	11.75	298	-
20⇒18	20.00	508	18.00	457	15.00	381	14.50	368	101
20⇒16	20.00	508	16.00	406	15.00	381	14.00	356	98.6
20⇒14	20.00	508	14.00	356	15.00	381	14.00	356	97.4
20⇒12	20.00	508	12.75	321	15.00	381	13.62	346	-
20⇒10	20.00	508	10.75	273	15.00	381	13.12	333	-
20⇒8	20.00	508	8.62	219	15.00	381	12.75	324	-
22⇒20	22.00	559	20.00	508	16.50	419	16.00	406	123
22⇒18	22.00	559	18.00	457	16.50	419	15.50	394	120
22⇒16	22.00	559	16.00	406	16.50	419	15.00	381	118
22⇒14	22.00	559	14.00	356	16.50	419	15.00	381	-
22⇒12	22.00	559	12.75	324	16.50	419	14.62	371	-
22⇒10	22.00	559	10.75	273	16.50	419	14.12	359	-
24⇒22	24.00	610	22.00	559	17.00	432	17.00	432	138
24⇒20	24.00	610	20.00	508	17.00	432	17.00	432	137
24⇒18	24.00	610	18.00	457	17.00	432	16.50	419	134
24⇒16	24.00	610	16.00	406	17.00	432	16.00	406	-
24⇒14	24.00	610	14.00	356	17.00	432	16.00	406	-
24⇒12	24.00	610	12.75	324	17.00	432	15.62	397	-
24⇒10	24.00	610	10.75	273	17.00	432	15.12	384	-
26⇒24	26.00	660	24.00	610	19.50	495	19.00	483	-
26⇒22	26.00	660	22.00	559	19.50	495	18.50	470	-
26⇒20	26.00	660	20.00	508	19.50	495	18.00	457	-
26⇒18	26.00	660	18.00	457	19.50	495	17.50	444	-
Reducing tees 26⇒16, ⇒14 and ⇒12 are also available									
28⇒26	28.00	711	26.00	660	20.50	521	20.50	521	-
28⇒24	28.00	711	24.00	610	20.50	521	20.00	508	-
28⇒22	28.00	711	22.00	559	20.50	521	19.50	495	-
28⇒20	28.00	711	20.00	508	20.50	521	19.00	483	-
28⇒18	28.00	711	18.00	457	20.50	521	18.50	470	-
Reducing tees 28⇒16, ⇒14 and ⇒12 are also available									
30⇒28	30.00	762	28.00	711	22.00	559	21.50	546	-
30⇒26	30.00	762	26.00	660	22.00	559	21.50	546	-
30⇒24	30.00	762	24.00	610	22.00	559	21.00	533	-
30⇒22	30.00	762	22.00	559	22.00	559	20.50	521	-
30⇒20	30.00	762	20.00	508	22.00	559	20.00	508	-
Reducing tees 30⇒18, ⇒16, ⇒14, ⇒12 and ⇒10 are also available									
32⇒30	32.00	813	30.00	762	23.50	597	23.00	584	-



# Butt Weld Fittings

## Range/Sizes - Reducing Tees - ANSI B16.9

Nominal Pipe Size	Run OD		Outlet OD		Run		Outlet		Weight
	OD at Bevel		OD at Bevel		A		B		40S/STD <sup>1</sup>
	in	mm	in	mm	in	mm	in	mm	kg/piece
32⇨28	32.00	813	28.00	711	23.50	597	22.50	572	-
32⇨26	32.00	813	26.00	660	23.50	597	22.50	572	-
32⇨24	32.00	813	24.00	610	23.50	597	22.00	559	-
Reducing tees 32⇨22, ⇨20, ⇨18, ⇨16 and ⇨14 are also available									
34⇨32	34.00	864	32.00	813	25.00	635	24.50	622	-
34⇨30	34.00	864	30.00	762	25.00	635	24.00	610	-
34⇨28	34.00	864	28.00	711	25.00	635	23.50	597	-
34⇨26	34.00	864	26.00	660	25.00	635	23.50	597	-
34⇨24	34.00	864	24.00	610	25.00	635	23.00	584	-
Reducing tees 34⇨22, ⇨20, ⇨18, and ⇨16 are also available									
36⇨34	36.00	914	34.00	864	26.50	673	26.00	660	-
36⇨32	36.00	914	32.00	813	26.50	673	25.50	648	-
36⇨30	36.00	914	30.00	762	26.50	673	25.00	635	-
36⇨28	36.00	914	28.00	711	26.50	673	24.50	622	-
36⇨26	36.00	914	26.00	660	26.50	673	24.50	622	-
36⇨24	36.00	914	24.00	610	26.50	673	24.00	610	-
Reducing tees 36⇨22, ⇨20, ⇨18, and ⇨16 are also available									
38⇨36	38.00	965	36.00	914	28.00	711	28.00	711	-
38⇨34	38.00	965	34.00	864	28.00	711	27.50	698	-
38⇨32	38.00	965	32.00	813	28.00	711	27.00	686	-
38⇨30	38.00	965	30.00	762	28.00	711	26.50	673	-
38⇨28	38.00	965	28.00	711	28.00	711	25.50	648	-
38⇨26	38.00	965	26.00	660	28.00	711	25.50	648	-
Reducing tees 38⇨24, ⇨22, ⇨20, and ⇨18 are also available									
40⇨38	40.00	1016	38.00	965	29.50	749	29.50	749	-
40⇨36	40.00	1016	36.00	914	29.50	749	29.00	737	-
40⇨34	40.00	1016	34.00	864	29.50	749	28.50	724	-
40⇨32	40.00	1016	32.00	813	29.50	749	28.00	711	-
40⇨30	40.00	1016	30.00	762	29.50	749	27.50	698	-
Reducing tees 40⇨28, ⇨26, ⇨24, ⇨22, ⇨20, and ⇨18 are also available									
42⇨40	42.00	1067	40.00	1016	30.00	762	28.00	711	-
42⇨38	42.00	1067	38.00	965	30.00	762	28.00	711	-
42⇨36	42.00	1067	36.00	914	30.00	762	28.00	711	-
42⇨34	42.00	1067	34.00	864	30.00	762	28.00	711	-
42⇨32	42.00	1067	32.00	813	30.00	762	28.00	711	-
42⇨30	42.00	1067	30.00	762	30.00	762	28.00	711	-
Reducing tees 42⇨28, ⇨26, ⇨24, ⇨22, ⇨20, ⇨18, and ⇨16 are also available									
44⇨42	44.00	1118	42.00	1067	32.00	813	30.00	762	-
44⇨40	44.00	1118	40.00	1016	32.00	813	29.50	749	-
44⇨38	44.00	1118	38.00	965	32.00	813	29.00	737	-
44⇨36	44.00	1118	36.00	914	32.00	813	28.50	724	-
Reducing tees 44⇨34, ⇨32, ⇨30, ⇨28, ⇨26, ⇨24, ⇨22, and ⇨20 are also available									
46⇨44	46.00	1168	44.00	1118	33.50	851	31.50	800	-
46⇨42	46.00	1168	42.00	1067	33.50	851	31.00	787	-
46⇨40	46.00	1168	40.00	1016	33.50	851	30.50	775	-
46⇨38	46.00	1168	38.00	965	33.50	851	30.00	762	-
Reducing tees 46⇨36, ⇨34, ⇨32, ⇨30, ⇨28, ⇨26, ⇨24, and ⇨22 are also available									
48⇨46	48.00	1219	46.00	1168	35.00	889	33.00	838	-
48⇨44	48.00	1219	44.00	1118	35.00	889	33.00	838	-
48⇨42	48.00	1219	42.00	1067	35.00	889	32.00	813	-
48⇨40	48.00	1219	40.00	1016	35.00	889	32.00	813	-
Reducing tees 48⇨38, ⇨36, ⇨34, ⇨32, ⇨30, ⇨28, ⇨26, ⇨24, and ⇨22 are also available									

### Notes

- For run size NPS 14 and larger, outlet dimension B is recommended but not required.
- Dimensions quoted in mm are 'Nominal' values from B16.9 (i.e. rounded equivalents of the inch dimensions). Refer to B16.9 for additional 'Max' and 'Min' metric dimensions.
- The run and outlet NPS sizes are as shown in the left hand column. The corresponding size designation for a reducing tee is, for example, for the tee shown as 4⇨3 : 4 x 4 x 3, and for the tee shown as 44⇨36 : 44 x 44 x 36.
- For tolerances see page 3-14.

<sup>1</sup> Weights are approximate and based on manufacturers' data (where available) for Schedule 40S/Standard fittings. See page 3-15 for further information.

# Butt Weld Fittings

## Range/Sizes - Concentric and Eccentric Reducers - ANSI B16.9

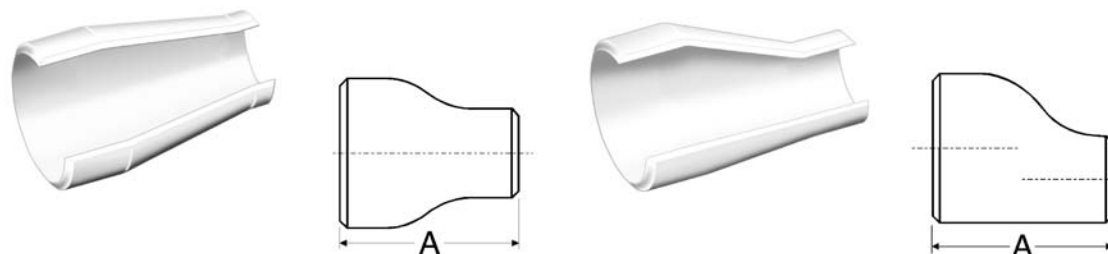

Dimensions (based on ASME/ANSI B16.9) and example weights for reducers

Nominal Pipe Size	Large End		Small End		End to End		Weight
	OD at Bevel		OD at Bevel		A		40S/STD <sup>1</sup>
	in	mm	in	mm	in	mm	kg/piece
3/4⇔1/2	1.05	27	0.84	21	1.50	38	0.06
3/4⇔3/8	1.05	27	0.68	17	1.50	38	-
1⇔3/4	1.32	33	1.05	27	2.00	51	0.12
1⇔1/2	1.32	33	0.84	21	2.00	51	0.11
1 1/4⇔1	1.66	42	1.32	33	2.00	51	0.16
1 1/4⇔3/4	1.66	42	1.05	27	2.00	51	0.14
1 1/4⇔1/2	1.66	42	0.84	21	2.00	51	0.13
1 1/2⇔1 1/4	1.90	48	1.66	42	2.50	64	0.24
1 1/2⇔1	1.90	48	1.32	33	2.50	64	0.22
1 1/2⇔3/4	1.90	48	1.05	27	2.50	64	0.20
1 1/2⇔1/2	1.90	48	0.84	21	2.50	64	0.18
2⇔1 1/2	2.38	60	1.90	48	3.00	76	0.37
2⇔1 1/4	2.38	60	1.66	42	3.00	76	0.35
2⇔1	2.38	60	1.32	33	3.00	76	0.32
2⇔3/4	2.38	60	1.05	27	3.00	76	0.30
2 1/2⇔2	2.88	73	2.38	60	3.50	89	0.72
2 1/2⇔1 1/2	2.88	73	1.90	48	3.50	89	0.66
2 1/2⇔1 1/4	2.88	73	1.66	42	3.50	89	0.63
2 1/2⇔1	2.88	73	1.32	33	3.50	89	-
3⇔2 1/2	3.50	89	2.88	73	3.50	89	0.93
3⇔2	3.50	89	2.38	60	3.50	89	0.85
3⇔1 1/2	3.50	89	1.90	48	3.50	89	0.78
3⇔1 1/4	3.50	89	1.66	42	3.50	89	0.75
3 1/2⇔3	4.00	102	3.50	89	4.00	102	-
3 1/2⇔2 1/2	4.00	102	2.88	73	4.00	102	-
3 1/2⇔2	4.00	102	2.38	60	4.00	102	-
3 1/2⇔1 1/2	4.00	102	1.90	48	4.00	102	-
Reducers 3 1/2⇔1 1/4, and 4, 5, 6, & 8⇔3 1/2 are also available							
4⇔3 1/2	4.50	114	4.00	102	4.00	102	-
4⇔3	4.50	114	3.50	89	4.00	102	1.45
4⇔2 1/2	4.50	114	2.88	73	4.00	102	1.37
4⇔2	4.50	114	2.38	60	4.00	102	1.27
4⇔1 1/2	4.50	114	1.90	48	4.00	102	1.18
5⇔4	5.56	141	4.50	114	5.00	127	2.50
5⇔3	5.56	141	3.50	89	5.00	127	2.27
5⇔2 1/2	5.56	141	2.88	73	5.00	127	2.16
6⇔5	6.62	168	5.56	141	5.50	140	3.57
6⇔4	6.62	168	4.50	114	5.50	140	3.30
6⇔3	6.62	168	3.50	89	5.50	140	3.04
8⇔6	8.62	219	6.62	168	6.00	152	5.71
8⇔5	8.62	219	5.56	141	6.00	152	5.40
8⇔4	8.62	219	4.50	114	6.00	152	5.10
10⇔8	10.75	273	8.62	219	7.00	178	9.58
10⇔6	10.75	273	6.62	168	7.00	178	8.78
10⇔5	10.75	273	5.56	141	7.00	178	8.42

# Butt Weld Fittings

## Range/Sizes - Concentric and Eccentric Reducers - ANSI B16.9

Nominal Pipe Size	Large End		Small End		End to End		Weight
	OD at Bevel		OD at Bevel		A		40S/STD <sup>1</sup>
	in	mm	in	mm	in	mm	kg/piece
12⇒10	12.75	324	10.75	273	8.00	203	13.6
12⇒8	12.75	324	8.62	219	8.00	203	12.7
12⇒6	12.75	324	6.62	168	8.00	203	11.8
14⇒12	14.00	356	12.75	324	13.00	330	25.4
14⇒10	14.00	356	10.75	273	13.00	330	23.6
14⇒8	14.00	356	8.62	219	13.00	330	21.8
16⇒14	16.00	406	14.00	356	14.00	356	31.0
16⇒12	16.00	406	12.75	324	14.00	356	29.6
16⇒10	16.00	406	10.75	273	14.00	356	27.8
18⇒16	18.00	457	16.00	406	15.00	381	37.8
18⇒14	18.00	457	14.00	356	15.00	381	35.7
18⇒12	18.00	457	12.75	324	15.00	381	34.3
20⇒18	20.00	508	18.00	457	20.00	508	56.4
20⇒16	20.00	508	16.00	406	20.00	508	53.5
20⇒14	20.00	508	14.00	356	20.00	508	50.8
22⇒20	22.00	559	20.00	508	20.00	508	62.6
22⇒18	22.00	559	18.00	457	20.00	508	59.7
22⇒16	22.00	559	16.00	406	20.00	508	57.1
24⇒22	24.00	610	22.00	559	20.00	508	68.6
24⇒20	24.00	610	20.00	508	20.00	508	65.7
24⇒18	24.00	610	18.00	457	20.00	508	63.0
26⇒24	26.00	660	24.00	610	24.00	610	-
26⇒22	26.00	660	22.00	559	24.00	610	-
26⇒20	26.00	660	20.00	508	24.00	610	-
26⇒18	26.00	660	18.00	457	24.00	610	-
28⇒26	28.00	711	26.00	660	24.00	610	-
28⇒24	28.00	711	24.00	610	24.00	610	-
28⇒20	28.00	711	20.00	508	24.00	610	-
28⇒18	28.00	711	18.00	457	24.00	610	-
30⇒28	30.00	762	28.00	711	24.00	610	-
30⇒26	30.00	762	26.00	660	24.00	610	-
30⇒24	30.00	762	24.00	610	24.00	610	-
30⇒20	30.00	762	20.00	508	24.00	610	-
32⇒30	32.00	813	30.00	762	24.00	610	-
32⇒28	32.00	813	28.00	711	24.00	610	-
32⇒26	32.00	813	26.00	660	24.00	610	-
32⇒24	32.00	813	24.00	610	24.00	610	-
34⇒32	34.00	864	32.00	813	24.00	610	-
34⇒30	34.00	864	30.00	762	24.00	610	-
34⇒26	34.00	864	26.00	660	24.00	610	-
34⇒24	34.00	864	24.00	610	24.00	610	-
36⇒34	36.00	914	34.00	864	24.00	610	-
36⇒32	36.00	914	32.00	813	24.00	610	-
36⇒30	36.00	914	30.00	762	24.00	610	-
36⇒26	36.00	914	26.00	660	24.00	610	-
36⇒24	36.00	914	24.00	610	24.00	610	-

Reducers 38⇒36/34/32/30/28/26, 40⇒38/36/34/32/30, 42⇒40/38/36/34/32/30, 44⇒42/40/38/36, 46⇒44/42/40 and 48⇒46/44/42/40 are also available

### Notes

- Dimensions quoted in mm are 'Nominal' values from B16.9 (i.e. rounded equivalents of the inch dimensions). Refer to B16.9 for additional 'Max' and 'Min' metric dimensions.
- For tolerances see page 3-14.
- Other sizes listed in B16.9 are 5⇒2, 6⇒2½, 10⇒4, 12⇒5, 14⇒6, 16⇒8, 18⇒10, 20⇒12, 22⇒14 and 24⇒16.
- <sup>1</sup> Weights are approximate and based on manufacturers' data (where available) for Schedule 40S/Standard fittings. See page 3-15 for further information.

# Butt Weld Fittings

## Range/Sizes - End Caps - ANSI B16.9

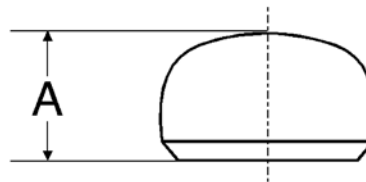

### Dimensions (based on ASME/ANSI B16.9) and example weights

Nominal Pipe Size	Common		Limiting Wall Thickness		Length for wall $\leq T$		Length for wall $> T$		Weight
	OD at Bevel		T		A				40S/STD <sup>1</sup>
	in	mm	in	mm	in	mm	in	mm	kg/piece
1/2	0.84	21	0.145	3.73	1.00	25	1.00	25	0.04
3/4	1.05	27	0.15	3.91	1.00	25	1.00	25	0.05
1	1.32	33	0.18	4.55	1.50	38	1.50	38	0.11
1 1/4	1.66	42	0.19	4.85	1.50	38	1.50	38	0.14
1 1/2	1.90	48	0.20	5.08	1.50	38	1.50	38	0.17
2	2.38	60	0.22	5.54	1.50	38	1.75	44	0.23
2 1/2	2.88	73	0.28	7.01	1.50	38	2.00	51	0.39
3	3.50	89	0.30	7.62	2.00	51	2.50	64	0.66
3 1/2	4.00	102	0.32	8.08	2.50	64	3.00	76	-
4	4.50	114	0.34	8.56	2.50	64	3.00	76	1.17
5	5.56	141	0.38	9.53	3.00	76	3.50	89	1.91
6	6.62	168	0.43	10.97	3.50	89	4.00	102	2.90
8	8.62	219	0.50	12.70	4.00	102	5.00	127	5.19
10	10.75	273	0.50	12.70	5.00	127	6.00	152	9.15
12	12.75	324	0.50	12.70	6.00	152	7.00	178	13.3
14	14.00	356	0.50	12.70	6.50	165	7.50	191	15.9
16	16.00	406	0.50	12.70	7.00	178	8.00	203	20.0
18	18.00	457	0.50	12.70	8.00	203	9.00	229	25.6
20	20.00	508	0.50	12.70	9.00	229	10.00	254	31.9
22	22.00	559	0.50	12.70	10.00	254	10.00	254	38.8
24	24.00	610	0.50	12.70	10.50	267	12.00	305	45.1
26	26.00	660	-	-	10.50	267	Subject to agreement with purchaser	53.8	
28	28.00	711	-	-	10.50	267		62.4	
30	30.00	762	-	-	10.50	267		71.7	
32	32.00	813	-	-	10.50	267		81.6	
34	34.00	864	-	-	10.50	267		-	
36	36.00	914	-	-	10.50	267		103	
38	38.00	965	-	-	12.00	305		-	
40	40.00	1016	-	-	12.00	305		127	
42	42.00	1067	-	-	12.00	305		140	
44	44.00	1118	-	-	13.50	343		-	
46	46.00	1168	-	-	13.50	343		-	
48	48.00	1219	-	-	13.50	343		-	

#### Notes

- Dimensions quoted in mm (except T) are 'Nominal' values from B16.9 (rounded equivalents of the inch dimensions). Refer to B16.9 for additional 'Max' and 'Min' metric dimensions.
- The shape of caps shall be ellipsoidal and conform to shape requirements in the ASME Boiler and Pressure Code.
- For tolerances see page 3-14.

1 Weights are approximate and based on manufacturers' data (where available) for Schedule 40S/Standard fittings. See page 3-15 for further information.

# Butt Weld Fittings

## Range/Sizes - Lap Joint Stub Ends - ANSI B16.9

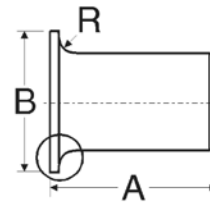
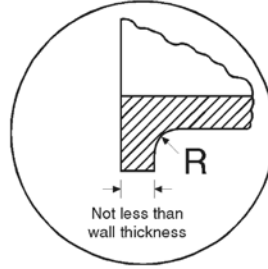
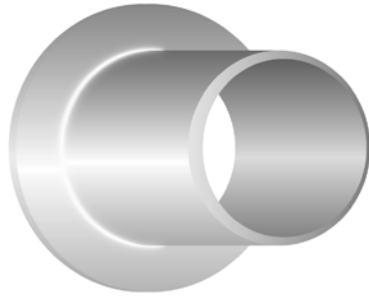

### Dimensions (based on ASME/ANSI B16.9) and example weights

Nominal Pipe Size	Common		Long Pattern		Short Pattern		Diameter of Lap		Radius of Fillet		OD of Barrel				Weight
	OD at Bevel		A		A		B		R		max OD		min		40S/STD <sup>1</sup>
	in	mm	in	mm	in	mm	in	mm	in	mm	in	mm	in	mm	kg/piece
1/2	0.84	21	3.00	76	2.00	51	1.38	35	0.12	3	0.90	23	0.81	21	0.14
3/4	1.05	27	3.00	76	2.00	51	1.69	43	0.12	3	1.11	28	1.02	26	0.18
1	1.32	33	4.00	102	2.00	51	2.00	51	0.12	3	1.38	35	1.28	33	0.30
1 1/4	1.66	42	4.00	102	2.00	51	2.50	64	0.19	5	1.72	44	1.63	41	0.41
1 1/2	1.90	48	4.00	102	2.00	51	2.88	73	0.25	6	1.97	50	1.87	47	0.55
2	2.38	60	6.00	152	2.50	64	3.62	92	0.31	8	2.46	62	2.34	60	1.00
2 1/2	2.88	73	6.00	152	2.50	64	4.12	105	0.31	8	2.97	75	2.84	72	1.56
3	3.50	89	6.00	152	2.50	64	5.00	127	0.38	10	3.60	91	3.47	88	2.15
3 1/2	4.00	102	6.00	152	3.00	76	5.50	140	0.38	10	4.10	104	3.97	101	-
4	4.50	114	6.00	152	3.00	76	6.19	157	0.44	11	4.59	117	4.47	114	3.05
5	5.56	141	8.00	203	3.00	76	7.31	186	0.44	11	5.68	144	5.53	141	5.30
6	6.62	168	8.00	203	3.50	89	8.50	216	0.50	13	6.74	171	6.59	168	6.90
8	8.62	219	8.00	203	4.00	102	10.62	270	0.50	13	8.74	222	8.59	218	10.45
10	10.75	273	10.00	254	5.00	127	12.75	324	0.50	13	10.91	277	10.72	272	18.15
12	12.75	324	10.00	254	6.00	152	15.00	381	0.50	13	12.91	328	12.72	323	22.25
14	14.00	356	12.00	305	6.00	152	16.25	413	0.50	13	14.17	360	13.97	355	29.05
16	16.00	406	12.00	305	6.00	152	18.50	470	0.50	13	16.18	411	15.97	406	32.69
18	18.00	457	12.00	305	6.00	152	21.00	533	0.50	13	18.19	462	17.97	456	38.60
20	20.00	508	12.00	305	6.00	152	23.00	584	0.50	13	20.24	514	19.97	507	42.68
22	22.00	559	12.00	305	6.00	152	25.25	641	0.50	13	22.24	565	21.97	558	-
24	24.00	610	12.00	305	6.00	152	27.25	692	0.50	13	24.24	616	23.97	609	51.30

#### Notes

- Dimensions quoted in mm are 'Nominal' values from B16.9 (rounded equivalents of the inch dimensions). Refer to B16.9 for additional 'Max' and 'Min' metric dimensions.
- OD of barrel max and min dimensions (in and mm) are rounded. Refer to B16.9 for the exact values.
- Long pattern stub ends are standard. Purchaser should specify if short pattern is required. Long pattern stub ends are also known as ASA Stub Ends.
- Short pattern stub ends are used with larger flanges in Classes 300 and 600, and with most sizes in Class 900 and higher. When long pattern stub ends are used with flanges in Classes 1500 and 2500, it may be necessary to increase the length A.
- Additional lap thickness must be provided for special facings (e.g. tongue and groove); this is within length A.
- Dimension B conforms to ASME/ANSI B16.5, Pipe Flanges and Forged Fittings.
- Gasket face finish shall be accordance with ASME/ANSI B16.5 for raised face flanges.
- For tolerances see page 3-14.
- <sup>1</sup> Long pattern weights are listed (short pattern weights are similar to MSS SP-43 lap joint stub ends, page 3-11). Weights are approximate and based on manufacturers' data (where available) for Schedule 40S/Standard fittings. See page 3-15 for further information.

# Butt Weld Fittings

## Range/Sizes - Lap Joint Stub Ends - MSS SP-43

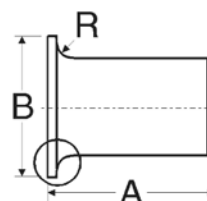
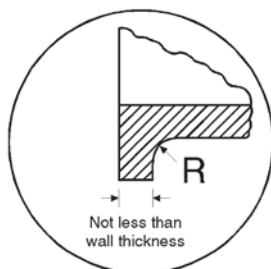
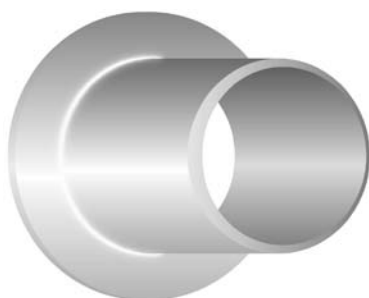

Note:  
Type A is shown.  
Type B has a square corner, as indicated by the maximum dimension R in the table below.

### Dimensions (based on MSS SP-43) and example weights

Nominal Pipe Size	Common		Length		Diameter of Lap		Radius of Fillet				Weight	
	OD at Bevel		A		B		Type A for Lap Joint Flange		R	Type B for Slip-on Flange		40S/STD <sup>1</sup>
	in	mm	in	mm	in	mm	in	mm		in	mm	kg/piece
1/2	0.84	21	2.00	51	1.38	35	0.12	3.05	0.03	0.76	0.09	
3/4	1.05	27	2.00	51	1.69	43	0.12	3.05	0.03	0.76	0.12	
1	1.32	33	2.00	51	2.00	51	0.12	3.05	0.03	0.76	0.15	
1 1/4	1.66	42	2.00	51	2.50	64	0.19	4.83	0.03	0.76	0.20	
1 1/2	1.90	48	2.00	51	2.88	73	0.25	6.35	0.03	0.76	0.28	
2	2.38	60	2.50	64	3.62	92	0.31	7.87	0.03	0.76	0.41	
2 1/2	2.88	73	2.50	64	4.12	105	0.31	7.87	0.03	0.76	0.66	
3	3.50	89	2.50	64	5.00	127	0.38	9.65	0.03	0.76	0.89	
3 1/2	4.00	102	3.00	76	5.50	140	0.38	9.65	0.03	0.76	-	
4	4.50	114	3.00	76	6.19	157	0.44	11.18	0.03	0.76	1.51	
5	5.56	141	3.00	76	7.31	186	0.44	11.18	0.06	1.52	2.66	
6	6.62	168	3.50	89	8.50	216	0.50	12.70	0.06	1.52	3.02	
8	8.62	219	4.00	102	10.62	270	0.50	12.70	0.06	1.52	5.22	
10	10.75	273	5.00	127	12.75	324	0.50	12.70	0.06	1.52	9.08	
12	12.75	324	6.00	152	15.00	381	0.50	12.70	0.06	1.52	13.35	
14	14.00	356	6.00	152	16.25	413	0.50	12.70	0.06	1.52	14.53	
16	16.00	406	6.00	152	18.50	470	0.50	12.70	0.06	1.52	16.34	
18	18.00	457	6.00	152	21.00	533	0.50	12.70	0.06	1.52	19.30	
20	20.00	508	6.00	152	23.00	584	0.50	12.70	0.06	1.52	21.34	
24	24.00	610	6.00	152	27.25	692	0.50	12.70	0.06	1.52	25.65	

#### Notes

- Dimensions quoted in mm are equivalents of the inch dimensions (i.e. 25.4 x in). Metric dimensions are not specified in MSS SP-43.
- Length A and Radius R are applicable for Schedule 40S or thinner.
- Contact faces of stub ends shall have a modified spiral or concentric serration.
- For tolerances see page 3-14.

<sup>1</sup> Weights are approximate and based on manufacturers' data (where available) for Schedule 40S/Standard fittings. See page 3-15 for further information.

# Butt Weld Fittings

## Specifications - ASTM A403

### Finish and repair

- **Surface discontinuities** deeper than 5% of nominal wall thickness to be removed.
- **Defect removal by grinding or machining.** The following are removed:
  - Surface discontinuity as above.
  - Surface checks (fishscale) deeper than  $\frac{1}{64}$  in (0.4mm).
  - Mechanical marks deeper than  $\frac{1}{16}$  in (1.6mm).
  - When removal reduces wall thickness below 87 $\frac{1}{2}$ % of nominal, the fitting is rejected or repaired.
- **Defect repair by welding**
  - Permitted for fitting made to specifications.
  - Purchaser agreement is necessary for weld repair of special fitting.
  - Repair is limited to 10% of outside surface and 33 $\frac{1}{3}$ % of nominal wall thickness.
  - All weld repairs are examined using liquid penetration test.
  - There should be no cracks in prepared cavities, or in finished weld, or in the surrounding  $\frac{1}{2}$  in (13mm) of base metal.

### Tensile requirements

Grade	UNS	Tensile Strength min		Yield Strength min		Elongation min% in 4D	
		ksi	MPa	ksi	MPa	Longit %	Trans %
<b>All</b>	<b>All</b>	<b>75</b>	<b>515</b>	<b>30</b>	<b>205</b>	<b>28</b>	<b>20</b>
<b>All = All grades listed in the chemical composition table except those listed below</b>							
304L	S30403	70	485	25	170	28	20
316L	S31603	70	485	25	170	28	20
304N	S30451	80	550	35	240	28	20
316N	S31651	80	550	35	240	28	20
XM-19	S20910	100	690	55	380	28	20
	S31254	94-119	650-820	44	300	28	20
	S34565	115	795	60	415	28	20
	S33228	73	500	27	185	28	20

Notes

- Grades or UNS designations are prefixed with letters 'WP' or 'CR' to indicate class.

# Butt Weld Fittings

## Specifications - General

### Applicable specifications

Specifications applicable to butt welding fittings are as follows:

- ◊ **ASME/ANSI B16.9-2007** - Factory-made wrought steel butt welding fittings.
- ◊ **ASME/ANSI B16.28-1997** - Wrought steel butt welding short radius elbows and returns.
- ◊ **MSS SP-43 1991**, Reaffirmed 1996 - Wrought stainless steel butt welding fittings. This applies to 5S, 10S, and 40S wall thicknesses only.
- ◊ **ASME/ANSI B16.25-1997** - Butt welding ends. This defines various weld bevel designs and dimensions, beyond the scope of this manual.
- ◊ **Wall Thicknesses.** Fittings are manufactured to match the wall thicknesses of pipe.
- ◊ **Weights** quoted in the fitting tables are based on manufacturers' data and are approximate. Actual weights may vary from those quoted depending on the type of construction. For austenitic and duplex stainless steel, multiply the quoted weight by 1.014. For ferritic and martensitic stainless steel, multiply the quoted weight by 0.985.

### Manufacture and test

- ◊ **Materials and Manufacture.** ASME/ANSI and MSS stainless steel butt welding fittings are most commonly manufactured to ASTM A403.
- ◊ **Production Testing.** Test requirements are defined in ASTM A430.
- ◊ **ASME/ANSI Test Requirements.** B16.9 and B16.28 do not require production testing of fittings although they must be capable of withstanding the rated pressure:

**Pressure Ratings.** The rated pressure is as for straight seamless pipe of equivalent NPS, wall thickness and material.

**Proof testing** to qualify the fitting design comprises a bursting strength test. The fitting is required to withstand, without rupture, 105% of the pressure P given by:  $P = (2St) / D$   
where

S = Actual ultimate tensile strength of a specimen from a representative fitting.

t = Nominal wall thickness

D = Outside diameter

- ◊ **MSS SP-43 Test Requirements.** SP-43 does not require hydrostatic testing of fittings although they must be capable of withstanding 1.5 times the pressure ratings at 100 °F:  
**Pressure Ratings.** Fittings produced to MSS SP-43 have the pressure ratings shown in this table.

Temperature	Schedule 5S	Schedule 10S
°F	Pressure, psi	
100	225	275
150	215	255
200	200	240
250	190	225
300	175	210
350	165	195
400	150	180
450	Not recommended for use at these temperatures	165
500		150
600		130
700		110
750		100



# Butt Weld Fittings

## Specifications - General

### Cross-sectional tolerances for all buttwelding fittings (ASME/ANSI B16.9 and B16.28)

Nominal Pipe Size (NPS)	All Fittings				Wall Thickness (t)
	OD at Bevel		ID at Bevel, ±		
	in	mm	in	mm	
1/2 to 2 1/2	+0.06, -0.03	+1.6, -0.8	0.03	0.8	Not less than 87.5% of nominal wall thickness
3 to 3 1/2	±0.06	±1.6	0.06	1.6	
4	±0.06	±1.6	0.06	1.6	
5 to 6	+0.09, -0.06	+3.2, -0.8	0.06	1.6	
8	+0.09, -0.06	+3.2, -0.8	0.06	1.6	
10	+0.16, -0.12	+4.8, -3.2	0.12	3.2	
12 to 18	+0.16, -0.12	+4.8, -3.2	0.12	3.2	
20 to 24	+0.25, -0.19	+6.35, -5.8	0.19	4.8	
26 to 30	+0.25, -0.19	+6.35, -5.8	0.19	4.8	
32 to 48	+0.25, -0.19	+6.35, -5.8	0.19	4.8	

### Dimensional tolerances for elbows and returns (ASME/ANSI B16.9 and B16.28)

Nominal Pipe Size (NPS)	90° and 45° Long Radius Elbows, 90° Short Radius Elbows, and Tees		180° Returns			
	Centre-to-End Dimension, ± A,B		Centre-to-Centre Dimension, ± B (=2 x A)		Back-to-face Dimension, ± C	
	in	mm	in	mm	in	mm
1/2 to 2 1/2	0.06	1.6	0.25	6.35	0.25	6.35
3 to 3 1/2	0.06	1.6	0.25	6.35	0.25	6.35
4	0.06	1.6	0.25	6.35	0.25	6.35
5 to 6	0.06	1.6	0.25	6.35	0.25	6.35
8	0.06	1.6	0.25	6.35	0.25	6.35
10	0.09	1.6	0.38	10.0	0.25	6.35
12 to 18	0.09	2.4	0.38	10.0	0.25	6.35
20 to 24	0.09	2.4	0.38	10.0	0.25	6.35
26 to 30	0.12	2.4	-	-	-	-
32 to 48	0.19	4.8	-	-	-	-

### Dimensional tolerances for reducers, end caps and stub ends (ASME/ANSI B16.9)

Nominal Pipe Size (NPS)	Reducers and Lap Joint Stub Ends		End Caps		Lap Joint Stub Ends				
	Overall Length, ± A		Overall Length, ± A		OD of Lap B		Fillet Radius of Lap R		OD of Barrel
	in	mm	in	mm	in	mm	in	mm	
1/2 to 2 1/2	0.06	1.6	0.12	3.2	+0, -0.03	+0, -1	+0, -0.03	+0, -1	See Lap Joint Stub Ends table for limiting dimension (page 3-10)
3 to 3 1/2	0.06	1.6	0.12	3.2	+0, -0.03	+0, -1	+0, -0.03	+0, -1	
4	0.06	1.6	0.12	3.2	+0, -0.03	+0, -1	+0, -0.06	+0, -2	
5 to 6	0.06	1.6	0.25	6.35	+0, -0.03	+0, -1	+0, -0.06	+0, -2	
8	0.06	1.6	0.25	6.35	+0, -0.03	+0, -1	+0, -0.06	+0, -2	
10	0.09	1.6	0.25	6.35	+0, -0.06	+0, -2	+0, -0.06	+0, -2	
12 to 18	0.09	2.4	0.25	6.35	+0, -0.06	+0, -2	+0, -0.06	+0, -2	
20 to 24	0.09	2.4	0.25	6.35	+0, -0.06	+0, -2	+0, -0.06	+0, -2	
26 to 30	0.19	2.4	0.38	10.0	-	-	-	-	
32 to 48	0.19	4.8	0.38	10.0	-	-	-	-	

# Butt Weld Fittings

## Weights

### Buttweld fitting weights

As mentioned previously, the ANSI/ASME and MSS buttweld fitting specifications do not specify wall thicknesses and weights for fittings. Weights quoted in the dimension and weight tables are therefore based on manufacturers' information and should be considered as approximate and provided as a guide only (fitting weights can vary considerably between manufacturers due to differences in construction). The example weights quoted are for 40S or Standard (STD) wall thicknesses only. It is possible to calculate the approximate weight at any other wall thicknesses using the factors provided in the table below. These factors are calculated from the ANSI/ASME B36.19M and B36.10M pipe weights and are based on the proportional relationship of the pipe weights (kg/m) to the weights of 40S and STD wall thickness pipe at each NPS.

**ASME/ANSI pipe sizes and weight multiplication factors for use in obtaining approximate fitting weights. For use with the example (40S/STD) weights provided in the ANSI/ASME tables of this section.**

NPS	Multiplication Factors = Proportional relationship of pipe weights to 40S or STD pipe at each NPS <sup>1</sup> . Multiply the example 40S/STD fitting weights (at the required NPS) by the factors below (at the same NPS) to give approximate weights at different wall thicknesses.																
	5S	10S	40S	80S	10	20	30	40	STD	60	XS	80	100	120	140	160	XXS
1/8	-	0.76	1.00	1.27	-	-	0.86	1.00	1.00	-	1.27	1.27	-	-	-	-	-
1/4	-	0.78	1.00	1.27	-	-	0.86	1.00	1.00	-	1.27	1.27	-	-	-	-	-
3/8	-	0.75	1.00	1.31	-	-	0.83	1.00	1.00	-	1.31	1.31	-	-	-	-	-
1/2	0.64	0.79	1.00	1.28	-	-	0.88	1.00	1.00	-	1.28	1.28	-	-	-	1.54	2.01
3/4	0.61	0.76	1.00	1.30	-	-	0.85	1.00	1.00	-	1.30	1.30	-	-	-	1.72	2.15
1	0.52	0.84	1.00	1.30	-	-	0.87	1.00	1.00	-	1.30	1.30	-	-	-	1.70	2.18
1 1/4	0.49	0.80	1.00	1.32	-	-	0.85	1.00	1.00	-	1.32	1.32	-	-	-	1.65	2.29
1 1/2	0.47	0.77	1.00	1.34	-	-	0.87	1.00	1.00	-	1.34	1.34	-	-	-	1.79	2.36
2	0.44	0.72	1.00	1.38	-	-	0.82	1.00	1.00	-	1.38	1.38	-	-	-	2.04	2.47
2 1/2	0.43	0.61	1.00	1.32	-	-	0.93	1.00	1.00	-	1.32	1.32	-	-	-	1.73	2.36
3	0.40	0.57	1.00	1.35	-	-	0.88	1.00	1.00	-	1.35	1.35	-	-	-	1.89	2.45
3 1/2	0.38	0.55	1.00	1.37	-	-	0.84	1.00	1.00	-	1.37	1.37	-	-	-	-	-
4	0.36	0.52	1.00	1.39	-	-	0.80	1.00	1.00	-	1.39	1.39	-	1.76	-	2.09	2.55
5	0.44	0.53	1.00	1.42	-	-	-	1.00	1.00	-	1.42	1.42	-	1.85	-	2.26	2.64
6	0.40	0.49	1.00	1.51	-	-	-	1.00	1.00	-	1.51	1.51	-	1.92	-	2.39	2.80
8	0.35	0.47	1.00	1.52	-	0.78	0.87	1.00	1.00	1.25	1.52	1.52	1.78	2.13	2.37	2.62	2.54
10	0.38	0.46	1.00	1.59	-	0.69	0.85	1.00	1.00	1.35	1.35	1.59	1.90	2.21	2.57	2.86	2.57
12	0.42	0.49	1.00	1.79	-	0.67	0.88	1.08	1.00	1.47	1.32	1.79	2.16	2.53	2.82	3.23	2.53
14	0.42	0.51	-	-	0.67	0.83	1.00	1.16	1.00	1.56	1.32	1.94	2.40	2.76	3.12	3.46	-
16	0.45	0.51	-	-	0.67	0.83	1.00	1.32	1.00	1.72	1.32	2.18	2.73	3.07	3.57	3.92	-
18	0.45	0.51	-	-	0.67	0.83	1.16	1.48	1.00	1.96	1.32	2.42	2.94	3.46	3.88	4.37	-
20	0.51	0.59	-	-	0.67	1.00	1.32	1.57	1.00	2.12	1.32	2.66	3.26	3.80	4.34	4.82	-
22	0.51	0.58	-	-	0.67	1.00	1.32	-	1.00	2.28	1.32	2.89	3.50	4.08	4.65	5.21	-
24	0.58	0.67	-	-	0.67	1.00	1.49	1.81	1.00	2.52	1.33	3.13	3.88	4.54	5.10	5.73	-
26	-	-	-	-	0.83	1.33	-	-	1.00	-	1.33	-	-	-	-	-	-
28	-	-	-	-	0.83	1.33	1.65	-	1.00	-	1.33	-	-	-	-	-	-
30	0.67	0.83	-	-	0.83	1.33	1.65	-	1.00	-	1.33	-	-	-	-	-	-
32	-	-	-	-	0.83	1.33	1.65	1.82	1.00	-	1.33	-	-	-	-	-	-
34	-	-	-	-	0.83	1.33	1.66	1.82	1.00	-	1.33	-	-	-	-	-	-
36	-	-	-	-	0.83	1.33	1.65	1.98	1.00	-	1.33	-	-	-	-	-	-
38	-	-	-	-	-	-	-	-	1.00	-	1.33	-	-	-	-	-	-
40	-	-	-	-	-	-	-	-	1.00	-	1.33	-	-	-	-	-	-
42	-	-	-	-	-	-	-	-	1.00	-	1.33	-	-	-	-	-	-
44	-	-	-	-	-	-	-	-	1.00	-	1.33	-	-	-	-	-	-
46	-	-	-	-	-	-	-	-	1.00	-	1.29	-	-	-	-	-	-
48	-	-	-	-	-	-	-	-	1.00	-	1.33	-	-	-	-	-	-

**Notes**

<sup>1</sup> The relationship between pipe weights at each NPS can strictly only be applied to fittings where the same proportional relationship is maintained in the fitting. Less accurate results will therefore be obtained for reducing tees, for example, than for elbows, equal tees, etc. The type of fitting construction may also make the factors inaccurate.

# BSP Fittings

## Introduction/Range

- BSP fittings are a family of fittings used to connect up threaded pipe and equipment.
- They are manufactured from pipe, bar, hollow bar, castings or forgings.
- The pipe to be threaded must have a wall thickness of Schedule 40S minimum.
- The fittings are used in non-critical, low pressure applications where welding is not possible or required. They therefore provide a relatively low cost method of connection.
- BSP fittings are usually fitted with a sealant (paste or tape such as PTFE) and are considered to be permanent pipe-work.
- Low Pressure BSP Fittings are rated at 150lb and are made to wrought iron specification BS 1740.
- BSP fittings are made only in type 316.
- They are provided with a Certificate of Conformity only, and not a full Test Certificate.
- Sizes 1/8 to 3 inch are the most commonly used and thus the most readily available.
- External MALE threads are tapered and Internal FEMALE threads are parallel. The threads are cut to BS21: Part 1: 1985 and are called Whitworth Threads – See below.



90° Elbow

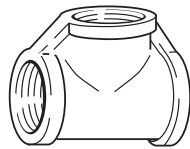

Equal Tee

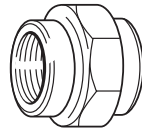

Union

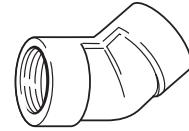

45° Elbow



Half Socket

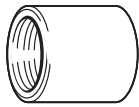

Socket



Round Nut



Reducing Socket

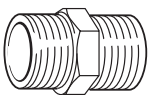

Hexagon Nipple

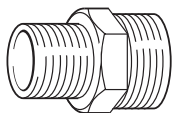

Reducing Nipple

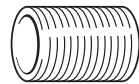

Equal Nipple



Cap

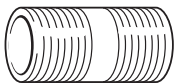

Barrel Nipple

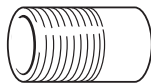

Welding Nipple



Square Head Plug

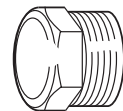

Hexagon Head Plug

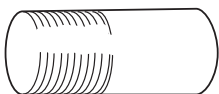

Hose Connector



Reducing Bush



Hexagon Nut

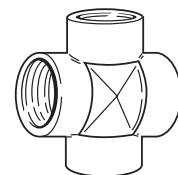

Cross

# BSP Fittings

## Sizes/Specifications

### Dimensions

Nominal Size of Outlet		<b>D</b> Min O/D	<b>E</b> Min O/D of body behind external thread	<b>d</b> Min I/D of body behind internal thread	No. of threads per inch
in	mm	mm	mm	mm	
1/4	6	15.0	9.8	8.6	28
5/16	8	18.5	13.3	11.4	19
3/8	10	22.0	16.8	15.0	19
5/8	15	27.0	21.1	18.6	14
3/4	20	32.5	26.6	24.1	14
1	25	39.5	33.4	30.3	11
1 1/4	32	49.0	42.1	39.0	11
1 1/2	40	56.0	48.0	44.8	11
2	50	68.0	59.8	56.7	11
1/2	65	84.0	75.4	72.2	11
3	75	98.0	88.1	84.9	11
4	100	124.0	113.3	110.1	11
5	125	151.0	138.7	135.5	11
6	150	178.0	164.1	160.9	11





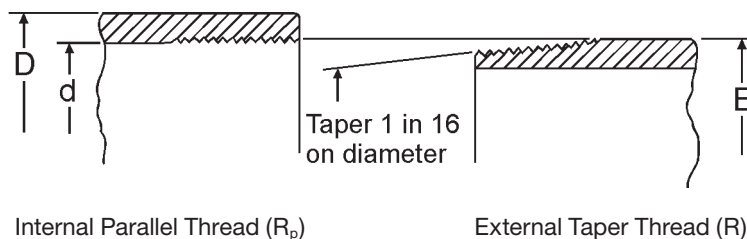





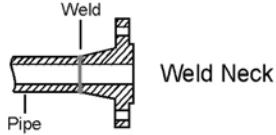

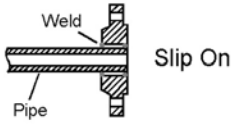
### Threading requirements

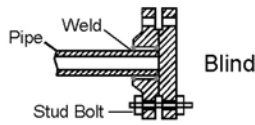
Fittings manufactured to BS 1740 are threaded in accordance with BS 21:1985, Pipe threads for tubes and fittings where pressure-tight joints are made on the threads.

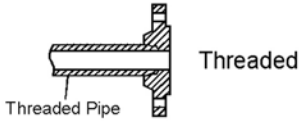

### Tolerances (BS 1740)

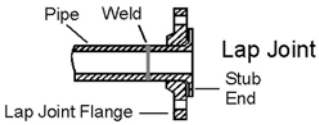
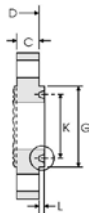
Nominal Pipe Size	Length of Socket Unions	Length or Centre to Face Tolerances for Other Fittings
	±mm	±mm
≤25	6	1.5
25 to 40	6	3.0
>40 to 65	10	4.5
>65 to 75	12	6.0
>75 to 110	16	-
>75 to 150	-	8.0
>150	-	10.0

Type	Joining Method	General Description
<b>Weld Neck</b> 		<p>Used in critical applications. These are circumferentially welded onto the system at their necks which means that the integrity of the butt-welded area can easily be examined by X-ray radiography. The bores of both pipe and flange match thus reducing turbulence and erosion.</p>
<b>Slip On</b> 		<p>This is slipped over the pipe and then fillet welded. Easy to use in fabricated applications.</p>
<b>Blind</b> 		<p>Sometimes called a blanking flange, this is used for blanking off pipelines, valves and pumps and as an inspection cover.</p>
<b>Socket Weld</b> 		<p>This is counter-bored to accept the pipe, which is then fillet welded. The bore of both the pipe and the flange are the same to ensure good flows.</p>
<b>Screwed/Threaded</b> 		<p>This requires no welding and is used to connect other threaded components in low pressure noncritical applications.</p>
<b>Lap Joint</b> 		<p>These are always used with either a stub end or a taft which is butt-welded to the pipe with the flange loose behind it. Thus the stub end or the taft always provides the sealing face. Easily assembled and aligned, it is favoured in low pressure applications. To reduce cost these 'backing' flanges can be supplied without a hub and/or made from coated carbon steel.</p>
<b>Ring Type Joint</b> 		<p>This can be employed on Weld Neck, Slip On or Blind Flanges for leak-proof connection at high pressures. The seal is made by a metal ring being compressed into a hexagonal groove on the flange face.</p>

# Flanges

## Introduction

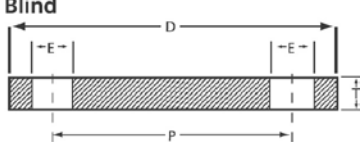
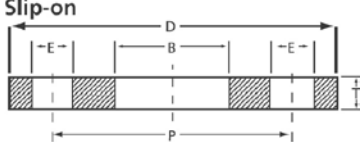
Type	General Description
<p><b>Plate or Table (BS 10:1962)</b>  <b>Standard BS10 Flanges</b></p> <p><b>Blind</b></p>  <p><b>Slip-on</b></p> 	<p>These are produced to suit Nominal Bore/NPS Pipe Sizes. They are produced from bar or plate rather than forgings and are not pressure-rated.</p> <p>Blind and Slip-On, flat-faced, types are readily available in grades 304L and 316L in sizes from 1/2" to 6" as Table D and Table E, with larger sizes and other Tables (thicknesses) made to order.</p> <p>These economical flanges are used for light-duty applications where corrosion resistance is the primary consideration rather than high pressure or temperature.</p>
<p><b>BS EN 1092 Part 1</b>  <b>Also referred to as PN Flanges</b>  <b>(Formerly BS4504)</b></p>	<p>These are not interchangeable with ANSI Flanges. They are readily available in types 304L and 316L with various pressure ratings of which 10 Bar &amp; 16 Bar are the most commonly used.</p>
<p><b>Metric ND/DN</b></p>	<p>Please refer to information about the Metric ND product range in section 7.</p>
<p><b>Hygienic</b></p>	<p>Please refer to information about the Hygienics product range in section 6.</p>

### Flange faces

Of the four choices available the most common configurations are:

- ◊ For ANSI and BS EN 1092 – Raised Face
- ◊ BS 10 – Flat Face.

Note that this does not apply to Screwed or Lap Joint Flanges.

Type	General Description
Raised Face	To facilitate welding
Flat Face	
Ring Type Joint (RTJ)	For leak-proof connection at high pressures
Tongue & Groove – Small or Large	

### Finish

The finish is given as a surface roughness measured as Arithmetic Average Roundness Height (AARH). The finish requirements are stipulated by the standards, such as ANSI B16.5 and are within the range 125AARH to 500AARH, which is equivalent to 3.2 to 12.5 Ra.

### Pressure ratings

(The pressure rating will also determine the dimensions of the flange – Full details can be found in the relevant specification.)

Flange Type	ANSI B16.5	ANSI B16.47 Series A MSS SP-44	ASME B16.47 Series B API 605	BS EN 1092/ (BS4504)
	lbs	lbs*	lbs*	Bar
Weld Neck	150-2500	150-900	150-300	2.5-40
Weld Neck Ring Type Joint	300-2500	300-900	150-300	N/A
Slip On	150-1500	-	-	2.5-40
Slip On Ring Type Joint	300-1500	-	-	N/A
Threaded	150-2500	-	-	6-40
Lap Joint	150-2500	-	-	6-40
Blind	150-2500	-	-	2.5-40
Socket Weld	150-1500	-	-	N/A

Notes

\* Flange sizes 26" and above.

### What semi-finished product are flanges made from?

	Forging A182	Plate ASTM A240	Bar	Casting
ANSI B16.5	✓	✓	-	-
BS 3293	✓	-	-	-
MSS SP-44	✓	-	-	-
API 605	✓	-	-	-
BS EN 1092/(BS4504)	✓	✓	-	✓
BS 10	✓	✓	✓	✓

Notes

- ASTM A240 plate can be used to manufacture ANSI B16.5 blind flanges, but this is not generally accepted in the UK.
- Most small BS 10 flanges are normally made from bar as this is the most economical manufacturing process.

# Flanges

## Range/Sizes - Weld Neck Flanges - ANSI B16.5

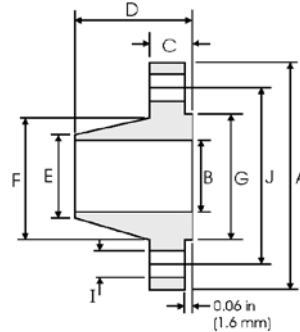

### Class 150 lb

Pipe		Flange Data				Hub Data		Raised Face	Drilling Data			Weight
Nominal Pipe Size	Outside Diameter	A	B	C	D	E	F	G	H	I	J	kg/ piece
	in mm	in mm	in mm	in mm	in mm	in mm	in mm	in mm		in mm	in mm	
1/2	0.840 21.30	3.500 88.90	0.620 15.70	0.440 11.20	1.880 47.80	0.840 21.30	1.190 30.20	1.380 35.00	4	0.620 15.70	2.380 60.45	0.48
3/4	1.050 26.70	3.880 98.60	0.820 20.80	0.500 12.70	2.060 52.30	1.050 26.70	1.500 38.10	1.690 42.90	4	0.620 15.70	2.750 69.85	0.71
1	1.315 33.40	4.250 108.0	1.050 26.70	0.560 14.20	2.190 55.60	1.320 33.50	1.940 49.30	2.000 50.80	4	0.620 15.70	3.120 79.25	1.01
1 1/4	1.660 42.20	4.620 117.3	1.380 35.10	0.620 15.70	2.250 57.15	1.660 42.20	2.310 58.70	2.500 63.50	4	0.620 15.70	3.500 88.90	1.33
1 1/2	1.900 48.30	5.000 127.0	1.610 40.90	0.690 17.50	2.440 62.00	1.900 48.30	2.560 65.00	2.880 73.15	4	0.620 15.70	3.880 98.60	1.72
2	2.375 60.30	6.000 152.4	2.070 52.60	0.750 19.10	2.500 63.50	2.380 60.45	3.060 77.70	3.620 91.90	4	0.750 19.10	4.750 120.7	2.58
2 1/2	2.875 73.00	7.000 177.8	2.470 62.70	0.880 22.40	2.750 69.85	2.880 73.15	3.560 90.40	4.120 104.6	4	0.750 19.10	5.500 139.7	4.11
3	3.500 88.90	7.500 190.5	3.070 78.00	0.940 23.90	2.750 69.85	3.500 88.90	4.250 108.0	5.000 127.0	4	0.750 19.10	6.000 152.4	4.92
3 1/2	4.000 101.6	8.500 215.9	3.550 90.20	0.940 23.90	2.810 71.40	4.000 101.6	4.810 122.2	5.500 139.7	8	0.750 19.10	7.000 177.8	6.08
4	4.500 114.3	9.000 228.6	4.030 102.4	0.940 23.90	3.000 76.20	4.500 114.3	5.310 134.9	6.190 157.2	8	0.750 19.10	7.500 190.5	6.84
5	5.563 141.3	10.00 254.0	5.050 128.3	0.940 23.90	3.500 88.90	5.560 141.2	6.440 163.6	7.310 185.7	8	0.880 22.40	8.500 215.9	8.56
6	6.625 168.3	11.00 279.4	6.070 154.2	1.000 25.40	3.500 88.90	6.630 168.4	7.560 192.0	8.500 215.9	8	0.880 22.40	9.500 241.3	10.6
8	8.625 219.1	13.50 342.9	7.980 202.7	1.120 28.40	4.000 101.6	8.630 219.2	9.690 246.1	10.62 269.7	8	0.880 22.40	11.75 298.5	17.6
10	10.75 273.0	16.00 406.4	10.02 254.5	1.190 30.20	4.000 101.6	10.75 273.0	12.00 304.8	12.75 323.8	12	1.000 25.40	14.25 362.0	24.0
12	12.75 323.8	19.00 482.6	12.00 304.8	1.250 31.75	4.500 114.3	12.75 323.8	14.38 365.3	15.00 381.0	12	1.000 25.40	17.00 431.8	36.5
14	14.00 355.6	21.00 533.4	To be specified by Purchaser	1.380 35.10	5.000 127.0	14.00 355.6	15.75 400.1	16.25 412.7	12	1.120 28.40	18.75 476.3	48.4
16	16.00 406.4	23.50 596.9		1.440 36.60	5.000 127.0	16.00 406.4	18.00 475.2	18.50 469.9	16	1.120 28.40	21.25 539.8	60.6
18	18.00 457.2	25.00 635.0		1.560 39.60	5.500 139.7	18.00 457.2	19.88 505.0	21.00 533.4	16	1.250 31.75	22.75 577.9	68.3
20	20.00 508.0	27.50 698.5		1.690 42.90	5.690 144.5	20.00 508.0	22.00 558.8	23.00 584.2	20	1.250 31.75	25.00 635.0	84.5
24	24.00 609.6	32.00 812.8		1.880 47.80	6.000 152.4	24.00 609.6	26.12 663.4	27.25 692.1	20	1.380 35.10	29.50 749.3	115

#### Notes

- Dimension B corresponds to the pipe inside diameter. Values quoted assume 40S/Standard wall thickness.
- Weights are based on manufacturer's data and are approximate.
- Flat face flanges may be provided at full thickness, C, or with raised face removed (the latter is nonstandard).
- For tolerances see page 5-12.



## Range/Sizes - Weld Neck Flanges - ANSI B16.5

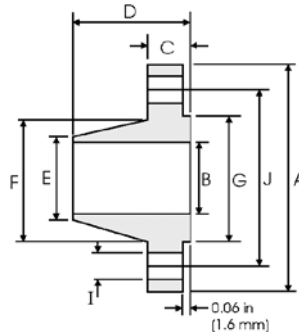

### Class 300 lb

Pipe		Flange Data				Hub Data		Raised Face	Drilling Data			Weight
Nominal Pipe Size	Outside Diameter	A	B	C	D	E	F	G	H	I	J	kg/ piece
	in mm	in mm	in mm	in mm	in mm	in mm	in mm	in mm		in mm	in mm	
1/2	0.840	3.750	0.620	0.560	2.060	0.840	1.500	1.380	4	0.620	2.620	0.75
	21.30	95.20	15.70	14.20	52.30	21.30	38.10	35.00		15.70	66.55	
3/4	1.050	4.620	0.820	0.620	2.250	1.050	1.880	1.690	4	0.750	3.250	1.26
	26.70	117.3	20.80	15.70	57.15	26.70	47.70	42.90		19.00	82.50	
1	1.315	4.880	1.050	0.690	2.440	1.320	2.120	2.000	4	0.750	3.500	1.52
	33.40	123.9	26.70	17.50	62.00	33.50	53.80	50.80		19.00	88.90	
1 1/4	1.660	5.250	1.380	0.750	2.560	1.660	2.500	2.500	4	0.750	3.880	2.03
	42.20	133.3	35.10	19.00	65.00	42.20	63.50	63.50		19.00	98.50	
1 1/2	1.900	6.120	1.610	0.810	2.690	1.900	2.750	2.880	4	0.880	4.500	2.89
	48.30	155.4	40.90	20.60	68.30	48.30	69.85	73.15		22.30	114.3	
2	2.375	6.500	2.070	0.880	2.750	2.380	3.310	3.620	8	0.750	5.000	3.40
	60.30	165.1	52.60	22.30	69.85	60.45	84.00	91.90		19.00	127.0	
2 1/2	2.875	7.500	2.470	1.000	3.000	2.880	3.940	4.120	8	0.880	5.880	5.17
	73.00	190.5	62.70	25.40	76.20	73.15	100.0	104.6		22.30	149.3	
3	3.500	8.250	3.070	1.120	3.120	3.500	4.620	5.000	8	0.880	6.620	6.93
	88.90	209.5	78.00	28.40	79.25	88.90	117.3	127.0		22.30	168.1	
3 1/2	4.000	9.000	3.550	1.190	3.190	4.000	5.250	5.500	8	0.880	7.250	8.67
	101.6	228.6	90.20	30.20	81.00	101.6	133.3	139.7		22.30	184.1	
4	4.500	10.00	4.030	1.250	3.380	4.500	5.750	6.190	8	0.880	7.880	11.2
	114.3	254.0	102.4	31.70	85.80	114.3	146.0	157.2		22.30	200.1	
5	5.563	11.00	5.050	1.380	3.880	5.560	7.000	7.310	8	0.880	9.250	15.1
	141.3	279.4	128.3	35.00	98.50	141.2	177.8	185.7		22.30	234.9	
6	6.625	12.50	6.070	1.440	3.880	6.630	8.120	8.500	12	0.880	10.62	19.1
	168.3	317.5	154.2	36.50	98.50	168.4	206.2	215.9		22.30	269.7	
8	8.625	15.00	7.980	1.620	4.380	8.630	10.25	10.62	12	1.000	13.00	29.9
	219.1	381.0	202.7	41.10	111.2	219.2	260.3	269.7		25.40	330.2	
10	10.75	17.50	10.02	1.880	4.620	10.75	12.62	12.75	16	1.120	15.25	42.7
	273.0	444.5	254.5	47.70	117.3	273.0	320.5	323.8		28.40	387.3	
12	12.75	20.50	12.00	2.000	5.120	12.75	14.75	15.00	16	1.250	17.75	61.8
	323.8	520.7	304.8	50.80	130.0	323.8	374.6	381.0		31.70	450.8	
14	14.00	23.00	To be specified by Purchaser	2.120	5.620	14.00	16.75	16.25	20	1.250	20.25	85.8
	355.6	584.2		53.80	142.7	355.6	425.4	412.7		31.70	514.3	
16	16.00	25.50		2.250	5.750	16.00	19.00	18.50	20	1.380	22.50	106
	406.4	647.7		57.15	146.0	406.4	482.6	469.9		35.00	571.5	
18	18.00	28.00		2.380	6.250	18.00	21.00	21.00	24	1.380	24.75	131
	457.2	711.2		60.45	158.7	457.2	533.4	533.4		35.00	628.6	
20	20.00	30.50	2.500	6.380	20.00	23.12	23.00	24	1.380	27.00	158	
	508.0	774.7	63.50	162.0	508.0	587.2	584.2		35.00	685.8		
24	24.00	36.00	2.750	6.620	24.00	27.62	27.25	24	1.620	32.00	230	
	609.6	914.4	69.85	168.1	609.6	701.5	692.1		41.10	812.8		

#### Notes

- Dimension B corresponds to the pipe inside diameter. Values quoted assume 40S/Standard wall thickness.
- Weights are based on manufacturer's data and are approximate.
- Flat face flanges may be provided at full thickness, C, or with raised face removed (the latter is nonstandard).
- For tolerances see page 5-12.

# Flanges

## Range/Sizes - Slip On Flanges - ANSI B16.5

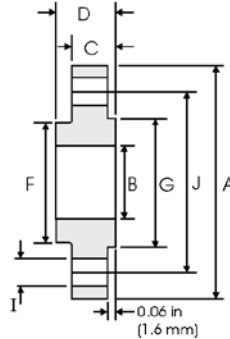

### Class 150 lb

Pipe		Flange Data				Hub	Raised Face	Drilling Data			Weight
Nominal Pipe Size	Outside Diameter	A	B	C	D	F	G	H	I	J	kg/ piece
	in mm	in mm	in mm	in mm	in mm	in mm	in mm	Number of Holes	in mm	in mm	
1/2	0.840 21.30	3.500 88.90	0.880 22.40	0.440 11.20	0.620 15.70	1.190 30.20	1.380 35.10	4	0.620 15.70	2.380 60.45	0.39
3/4	1.050 26.70	3.880 98.60	1.090 27.70	0.500 12.70	0.620 15.70	1.500 38.10	1.690 42.90	4	0.620 15.70	2.750 69.85	0.56
1	1.315 33.40	4.250 108.0	1.360 34.50	0.560 14.20	0.690 17.50	1.940 49.30	2.000 50.80	4	0.620 15.70	3.120 79.25	0.78
1 1/4	1.660 42.20	4.620 117.3	1.700 43.20	0.620 15.70	0.810 20.60	2.310 58.70	2.500 63.50	4	0.620 15.70	3.500 88.90	1.03
1 1/2	1.900 48.30	5.000 127.0	1.950 49.50	0.690 17.50	0.880 22.40	2.560 65.00	2.880 73.15	4	0.620 15.70	3.880 98.60	1.32
2	2.375 60.30	6.000 152.4	2.440 62.00	0.750 19.10	1.000 25.40	3.060 77.70	3.620 91.90	4	0.750 19.10	4.750 120.7	2.06
2 1/2	2.875 73.00	7.000 177.8	2.940 74.70	0.880 22.40	1.120 28.40	3.560 90.40	4.120 104.6	4	0.750 19.10	5.500 139.7	3.28
3	3.500 88.90	7.500 190.5	3.570 90.70	0.940 23.90	1.190 30.20	4.250 108.0	5.000 127.0	4	0.750 19.10	6.000 152.4	3.85
3 1/2	4.000 101.6	8.500 215.9	4.070 103.4	0.940 23.90	1.250 31.75	4.810 122.2	5.500 139.7	8	0.750 19.10	7.000 177.8	4.81
4	4.500 114.3	9.000 228.6	4.570 116.1	0.940 23.90	1.310 33.30	5.310 134.9	6.190 157.2	8	0.750 19.10	7.500 190.5	5.30
5	5.563 141.3	10.00 254.0	5.660 143.8	0.940 23.90	1.440 36.60	6.440 163.6	7.310 185.7	8	0.880 22.40	8.500 215.9	6.07
6	6.625 168.3	11.00 279.4	6.720 170.7	1.000 25.40	1.560 39.60	7.560 192.0	8.500 215.9	8	0.880 22.40	9.500 241.3	7.45
8	8.625 219.1	13.50 342.9	8.720 221.5	1.120 28.40	1.750 44.50	9.690 246.1	10.62 269.7	8	0.880 22.40	11.75 298.5	12.1
10	10.75 273.0	16.00 406.4	10.88 276.3	1.190 30.20	1.940 49.30	12.00 304.8	12.75 323.9	12	1.000 25.40	14.25 362.0	16.5
12	12.75 323.8	19.00 482.6	12.88 327.1	1.250 31.75	2.190 55.60	14.38 365.3	15.00 381.0	12	1.000 25.40	17.00 431.8	26.2
14	14.00 355.6	21.00 533.4	14.14 359.1	1.380 35.10	2.250 57.15	15.75 400.1	16.25 412.8	12	1.120 28.40	18.75 476.3	34.6
16	16.00 406.4	23.50 596.9	16.16 410.5	1.440 36.60	2.500 63.50	18.00 457.2	18.50 469.9	16	1.120 28.40	21.25 539.8	44.8
18	18.00 457.2	25.00 635.0	18.18 461.8	1.560 39.60	2.690 68.30	19.88 505.0	21.00 533.4	16	1.250 31.75	22.75 577.9	48.9
20	20.00 508.0	27.50 698.5	20.20 513.1	1.690 42.90	2.880 73.15	22.00 558.8	23.00 584.2	20	1.250 31.75	25.00 635.0	61.9
24	24.00 609.6	32.00 812.8	24.25 616.0	1.880 47.80	3.250 82.60	26.12 663.4	27.25 692.2	20	1.380 35.10	29.50 749.3	86.9

**Notes**

- Weights are based on manufacturer's data and are approximate.
- Flat face flanges may be provided at full thickness, C, or with raised face removed (the latter is nonstandard).
- For tolerances see page 5-12.

# Flanges

## Range/Sizes - Slip On Flanges - ANSI B16.5

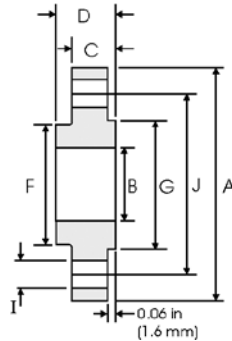

### Class 300 lb

Pipe		Flange Data				Hub	Raised Face	Drilling Data			Weight
Nominal Pipe Size	Outside Diameter	A	B	C	D	F	G	H	I	J	kg/ piece
	in mm	Overall Diameter in mm	Inside Diameter in mm	Flange Thickness min in mm	Overall Length in mm	Hub Diameter in mm	Face Diameter in mm	Number of Holes	Bolt Hole Diameter in mm	Diameter of Circle of Holes in mm	
1/2	0.840 21.30	3.750 95.20	0.880 22.40	0.560 14.20	0.880 22.40	1.500 38.10	1.380 35.10	4	0.620 15.70	2.620 66.55	0.64
3/4	1.050 26.70	4.620 117.3	1.090 27.70	0.620 15.70	1.000 25.40	1.880 47.70	1.690 42.90	4	0.750 19.10	3.250 82.50	1.12
1	1.315 33.40	4.880 123.9	1.360 34.50	0.690 17.50	1.060 26.90	2.120 53.80	2.000 50.80	4	0.750 19.10	3.500 88.90	1.36
1 1/4	1.660 42.20	5.250 133.3	1.700 43.20	0.750 19.00	1.060 26.90	2.500 63.50	2.500 63.50	4	0.750 19.10	3.880 98.60	1.68
1 1/2	1.900 48.30	6.120 155.4	1.950 49.50	0.810 20.60	1.190 30.20	2.750 69.85	2.880 73.15	4	0.880 22.40	4.500 114.3	2.49
2	2.375 60.30	6.500 165.1	2.440 62.00	0.880 22.30	1.310 33.20	3.310 84.00	3.620 91.90	8	0.750 19.10	5.000 127.0	2.87
2 1/2	2.875 73.00	7.500 190.5	2.940 74.70	1.000 25.40	1.500 38.10	3.940 100.0	4.120 104.6	8	0.880 22.40	5.880 149.4	4.32
3	3.500 88.90	8.250 209.5	3.570 90.70	1.120 28.40	1.690 42.90	4.620 117.3	5.000 127.0	8	0.880 22.40	6.620 168.1	5.85
3 1/2	4.000 101.6	9.000 228.6	4.070 103.4	1.190 30.20	1.750 44.40	5.250 133.3	5.500 139.7	8	0.880 22.40	7.250 184.2	7.34
4	4.500 114.3	10.00 254.0	4.570 116.1	1.250 31.70	1.880 47.70	5.750 146.0	6.190 157.2	8	0.880 22.40	7.880 200.1	9.61
5	5.563 141.3	11.00 279.4	5.660 143.8	1.380 35.00	2.000 50.80	7.000 177.8	7.310 185.7	8	0.880 22.40	9.250 234.9	12.3
6	6.625 168.3	12.50 317.5	6.720 170.7	1.440 36.50	2.060 52.30	8.120 206.2	8.500 215.9	12	0.880 22.40	10.62 269.7	15.6
8	8.625 219.1	15.00 381.0	8.720 221.5	1.620 41.10	2.440 61.90	10.25 260.3	10.62 269.7	12	1.000 25.40	13.00 330.2	24.2
10	10.75 273.0	17.50 444.5	10.88 276.3	1.880 47.70	2.620 66.55	12.62 320.5	12.75 323.9	16	1.120 28.40	15.25 387.3	34.1
12	12.75 323.8	20.50 520.7	12.88 327.1	2.000 50.80	2.880 73.15	14.75 374.6	15.00 381.0	16	1.250 31.70	17.75 450.8	49.8
14	14.00 355.6	23.00 584.2	14.14 359.1	2.120 53.80	3.000 76.20	16.75 425.4	16.25 412.8	20	1.250 31.70	20.25 514.4	69.9
16	16.00 406.4	25.50 647.7	16.16 410.5	2.250 57.15	3.250 82.50	19.00 482.6	18.50 469.9	20	1.380 35.00	22.50 571.5	88.1
18	18.00 457.2	28.00 711.2	18.18 461.8	2.380 60.45	3.500 88.90	21.00 533.4	21.00 533.4	24	1.380 35.00	24.75 628.7	109
20	20.00 508.0	30.50 774.7	20.20 513.1	2.500 63.50	3.750 95.20	23.12 587.2	23.00 584.2	24	1.380 35.00	27.00 685.8	134
24	24.00 609.6	36.00 914.4	24.25 616.0	2.750 69.85	4.190 106.4	27.62 701.5	27.25 692.2	24	1.620 41.00	32.00 812.8	201

#### Notes

- Weights are based on manufacturer's data and are approximate.
- Flat face flanges may be provided at full thickness, C, or with raised face removed (the latter is nonstandard).
- For tolerances see page 5-12.

# Flanges

## Range/Sizes - Blind Flanges - ANSI B16.5

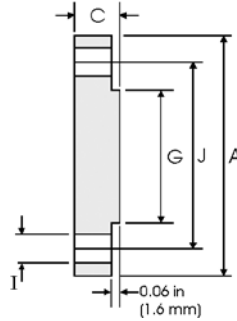
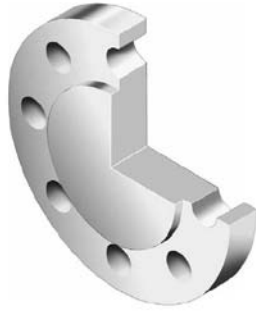

### Class 150 lb

Pipe		Flange Data		Raised Face	Drilling Data			Weight
Nominal Pipe Size	Outside Diameter	A Overall Diameter	C Flange Thickness min	G Face Diameter	H Number of Holes	I Bolt Hole Diameter	J Diameter of Circle of Holes	kg/ piece
	in mm	in mm	in mm	in mm		in mm	in mm	
1/2	0.840	3.500	0.440	1.380	4	0.620	2.380	0.42
	21.30	88.90	11.20	35.10		15.70	60.45	
3/4	1.050	3.880	0.500	1.690	4	0.620	2.750	0.61
	26.70	98.60	12.70	42.90		15.70	69.85	
1	1.315	4.250	0.560	2.000	4	0.620	3.120	0.86
	33.40	108.0	14.20	50.80		15.70	79.25	
1 1/4	1.660	4.620	0.620	2.500	4	0.620	3.500	1.17
	42.20	117.3	15.70	63.50		15.70	88.90	
1 1/2	1.900	5.000	0.690	2.880	4	0.620	3.880	1.53
	48.30	127.0	17.50	73.15		15.70	98.60	
2	2.375	6.000	0.750	3.620	4	0.750	4.750	2.42
	60.30	152.4	19.10	91.90		19.10	120.7	
2 1/2	2.875	7.000	0.880	4.120	4	0.750	5.500	3.94
	73.00	177.8	22.40	104.6		19.10	139.7	
3	3.500	7.500	0.940	5.000	4	0.750	6.000	4.93
	88.90	190.5	23.90	127.0		19.10	152.4	
3 1/2	4.000	8.500	0.940	5.500	8	0.750	7.000	6.17
	101.6	215.9	23.90	139.7		19.10	177.8	
4	4.500	9.000	0.940	6.190	8	0.750	7.500	7.00
	114.3	228.6	23.90	157.2		19.10	190.5	
5	5.563	10.00	0.940	7.310	8	0.880	8.500	8.63
	141.3	254.0	23.90	185.7		22.40	215.9	
6	6.625	11.00	1.000	8.500	8	0.880	9.500	11.3
	168.3	279.4	25.40	215.9		22.40	241.3	
8	8.625	13.50	1.120	10.62	8	0.880	11.75	19.6
	219.1	342.9	28.40	269.7		22.40	298.5	
10	10.75	16.00	1.190	12.75	12	1.000	14.25	28.8
	273.0	406.4	30.20	323.9		25.40	362.0	
12	12.75	19.00	1.250	15.00	12	1.000	17.00	43.2
	323.8	482.6	31.75	381.0		25.40	431.8	
14	14.00	21.00	1.380	16.25	12	1.120	18.75	58.1
	355.6	533.4	35.10	412.8		28.40	476.3	
16	16.00	23.50	1.440	18.50	16	1.120	21.25	76.0
	406.4	596.9	36.60	469.9		28.40	539.8	
18	18.00	25.00	1.560	21.00	16	1.250	22.75	93.7
	457.2	635.0	39.60	533.4		31.75	577.9	
20	20.00	27.50	1.690	23.00	20	1.250	25.00	122
	508.0	698.5	42.90	584.2		31.75	635.0	
24	24.00	32.00	1.880	27.25	20	1.380	29.50	185
	609.6	812.8	47.80	692.2		35.10	749.3	

**Notes**

- Weights are based on manufacturer's data and are approximate.
- Flat face flanges may be provided at full thickness, C, or with raised face removed (the latter is nonstandard).
- For tolerances see page 5-12.

## Range/Sizes - Blind Flanges - ANSI B16.5

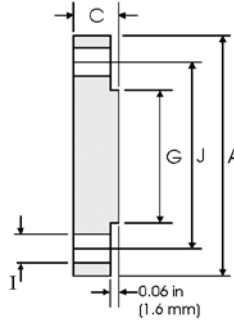

### Class 300 lb

Nominal Pipe Size	Pipe		Flange Data		Raised Face	Drilling Data			Weight
	Outside Diameter	A Overall Diameter	C Flange Thickness min	G Face Diameter	H Number of Holes	I Bolt Hole Diameter	J Diameter of Circle of Holes	kg/ piece	
	in mm	in mm	in mm	in mm		in mm	in mm		
1/2	0.840 21.30	3.750 95.20	0.560 14.20	1.380 35.10	4	0.620 15.70	2.620 66.55	0.64	
3/4	1.050 26.70	4.620 117.3	0.620 15.70	1.690 42.90	4	0.750 19.00	3.250 82.50	1.11	
1	1.315 33.40	4.880 123.9	0.690 17.50	2.000 50.80	4	0.750 19.00	3.500 88.90	1.39	
1 1/4	1.660 42.20	5.250 133.3	0.750 19.00	2.500 63.50	4	0.750 19.00	3.880 98.50	1.79	
1 1/2	1.900 48.30	6.120 155.4	0.810 20.60	2.880 73.15	4	0.880 22.3	4.500 114.3	2.66	
2	2.375 60.30	6.500 165.1	0.880 22.30	3.620 91.90	8	0.750 19.10	5.000 127.0	3.18	
2 1/2	2.875 73.00	7.500 190.5	1.000 25.40	4.120 104.6	8	0.880 22.30	5.880 149.3	4.85	
3	3.500 88.90	8.250 209.5	1.120 28.40	5.000 127.0	8	0.880 22.30	6.620 168.1	6.81	
3 1/2	4.000 101.6	9.000 228.6	1.190 30.20	5.500 139.7	8	0.880 22.30	7.250 184.1	8.71	
4	4.500 114.3	10.00 254.0	1.250 31.70	6.190 157.2	8	0.880 22.30	7.800 200.1	11.5	
5	5.563 141.3	11.00 279.4	1.380 35.00	7.310 185.7	8	0.880 22.30	9.250 234.9	15.6	
6	6.625 168.3	12.50 317.5	1.440 36.50	8.500 215.9	12	0.880 22.30	10.62 269.7	20.9	
8	8.625 219.1	15.00 381.0	1.620 41.10	10.62 269.7	12	1.000 25.40	13.00 330.2	34.3	
10	10.75 273.0	17.50 444.5	1.880 47.70	12.75 323.9	16	1.120 28.40	15.25 387.3	53.3	
12	12.75 323.8	20.50 520.7	2.000 50.80	15.00 381.0	16	1.250 31.70	17.75 450.8	78.8	
14	14.00 355.6	23.00 584.2	2.120 53.80	16.25 412.8	20	1.250 31.70	20.25 514.3	105	
16	16.00 406.4	25.50 647.7	2.250 57.15	18.50 469.9	20	1.380 35.00	22.50 571.5	137	
18	18.00 457.2	28.00 711.2	2.380 60.45	21.00 533.4	24	1.380 35.00	24.75 628.6	175	
20	20.00 508.0	30.50 774.7	2.500 63.50	23.00 584.2	24	1.380 35.00	27.00 685.8	221	
24	24.00 609.6	36.00 914.4	2.750 69.85	27.25 692.2	24	1.620 41.10	32.00 812.8	339	

#### Notes

- Weights are based on manufacturer's data and are approximate.
- Flat face flanges may be provided at full thickness, C, or with raised face removed (the latter is nonstandard).
- For tolerances see page 5-12.

# Flanges

## Specifications - ASTM A182/A182M

### Forged or rolled alloy – steel pipe flanges, forged fittings, and valves and parts for high temperature service

This specification covers forged low alloy and stainless steel piping components for use in pressure systems. These include flanges, fittings, valves and similar parts manufactured to dimensional standards such as ASME/ANSI. Products made to this specification are limited to a maximum weight of 10,000 lb (4,540 kg).

Note

- Although low alloy steels are covered by this standard, only stainless steels (martensitic, ferritic, austenitic and duplex) are included in this summary.

---

### Dimensions and tolerances

- ◊ **Dimensions and tolerances.** ASME/ANSI specifications B16.5 and B16.11 are referenced. **Flange dimensions and tolerances** (see page 5-12).

---

### Manufacture

- ◊ **Materials.** Refer to chemical composition table (stainless steel grades only shown). Elements not specified in the table are not permitted, specifically selenium or other elements added for free-machining properties.
- ◊ **The steel** may be melted by electric-furnace, or vacuum-furnace, or by either of these followed by vacuum or electroslag-consumable remelting. Vacuum melting or remelting is not suitable for grades containing or modified by nitrogen. Grade F XM-27Cb may be electron-beam melted.
- ◊ **Manufacture.** The steel is forged or rolled as near as possible to size and shape of the product. Small cylindrical parts (excluding flanges) may be machined directly from forged or rolled bar without additional hot working (limits defined in ASTM A234 apply for martensitic steels, in A403 for austenitic steels and A815 for duplex steels). Elbows, returns and tees are not machined directly from bar.
- ◊ **Heat treatment.** Refer to heat treatment table. Heat treatment of forgings may be performed before machining. For martensitic and ferritic grades, liquid quench followed by tempering is permitted, subject to purchaser agreement. Small cylindrical parts (excluding flanges) machined directly from forged or rolled austenitic steel may be furnished annealed to this specification with subsequent light cold drawing or straightening permitted.
- ◊ **Marking.** Each forging is marked with manufacturers name, heat number (or heat identification), designation of service rating, specification number, grade (e.g. F304) and size.  
Additionally: QT = Liquid quenched and tempered  
W = Welded  
WNS = Not post repair weld heat treated.

---

### Finish and repair

- ◊ **Appearance.** Forgings have a workmanlike finish and shall be free of scale, machining burns and injurious, imperfections (i.e. those that encroach on minimum wall thickness).
- ◊ **Defect repair by grinding or machining.** The following may be removed:
  - Surface discontinuity as above.
  - Mechanical marks, abrasions or pits deeper than  $\frac{1}{16}$  in (1.6mm).
- ◊ **Defect repair by welding:**
  - Permitted unless purchaser prohibits.
  - Defect removal by chipping or grinding is verified by magnetic particle inspection.
  - Repair is limited to 10% of surface area and  $33\frac{1}{3}\%$  of nominal wall thickness.
  - Repair welding electrodes and post weld repair heat treatments are defined in A182 but are not detailed in this summary.

### Tensile and hardness requirements

Grade	UNS	Tensile Strength min		Yield Strength <sup>1</sup> min		Elongation in 2 in (50 mm) or 4D, min	Reduction of area, min	Brinell Hardness HB
		ksi	MPa	ksi	MPa	%	%	
Martensitic Stainless Steels:								
F6a Class 1	S41000	70	485	40	275	18	35	143-187
F6a Class 2	S41000	85	585	55	380	18	35	167-229
F6a Class 3	S41000	110	760	85	585	15	35	235-302
F6a Class 4	S41000	130	895	110	760	12	35	263-321
F6b	S41026	110-135	760-930	90	620	16	45	235-285
F6NM	S41500	115	790	90	620	15	45	295 max
Ferritic Stainless Steels:								
FXM-27Cb	S44627	60	415	35	240	20	45	190 max
F429	S42900	60	415	35	240	20	45	190 max
F430	S43000	60	415	35	240	20	45	190 max
Austenitic Stainless Steels:								
All	All	75 <sup>2</sup>	515 <sup>2</sup>	30	205	30	50	-
F304L	S30403	70 <sup>3</sup>	485 <sup>3</sup>	25	170	30	50	-
F304N	S30451	80	550	35	240	30 <sup>4</sup>	50 <sup>5</sup>	-
F316L	S31603	70	485	25	170	30	50	-
F316N	S31651	80	550	35	240	30 <sup>4</sup>	50 <sup>5</sup>	-
F317L	S31703	70	485	25	170	30	50	-
FXM-11	S21904	90	620	50	345	45	60	-
FXM-19	S20910	100	690	55	380	35	55	-
F10	S33100	80	550	30	205	30	50	-
F44	S31254	94	650	44	300	35	50	-
F45	S30815	87	600	45	310	40	50	-
F46	S30600	78	540	35	240	40	50	-
F47	S31725	75	525	30	205	40	50	-
F48	S31726	80	550	35	240	40	50	-
F49	S34565	115	795	60	415	35	40	-
F56	S33228	73	500	27	185	30	35	-
Duplex Stainless Steels								
F50	S31200	100-130	690-895	65	450	25	50	-
F51	S31803	90	620	65	450	25	45	-
F52	S32950	100	690	70	485	15	-	-
F53	S32750	116 <sup>6</sup>	800 <sup>6</sup>	80 <sup>6</sup>	550 <sup>6</sup>	15	-	310 max
F54	S32740	116	800	80	550	15	30	310 max
F55	S32760	109-130	750-895	80	550	25	45	-
F57	S39277	118	820	85	585	25	50	-

#### Notes

- 1 Determined by the 0.2% offset method. For ferritic steels only, the 0.5% extension-under-load method may also be used.
  - 2 For sections over 5 in. [130mm] in thickness, the minimum tensile strength shall be 70 ksi [485 MPa].
  - 3 For sections over 5 in. [130mm] in thickness, the minimum tensile strength shall be 65 ksi [450 MPa].
  - 4 Longitudinal. The transverse elongation shall be 25% in 2 in. or 50mm, min.
  - 5 Longitudinal. The transverse reduction of area shall be 45% min.
  - 6 For sections over 2 in. [50mm] in thickness, the minimum tensile strength shall be 109 ksi [750 MPa]; the minimum yield strength shall be 75 ksi [515 MPa].
- All = All austenitic grades as listed in the chemical composition table except as identified in this table.



# Flanges

## Specifications - ASME/ANSI B16.5

American national standards ASME/ANSI B16.5 and B16.47 together cover pipe flanges up to NPS 60 (NPS 48 is the largest detailed in this summary). ASME/ANSI B16.47 covers two series of flanges, Series A which is equivalent to MSS SP-44 (the 1996 Edition of MSS SP-44 complies with B16.47 tolerances), and Series B which is equivalent to API 605 (API 605 is now cancelled).

### Dimensions and tolerances

#### Tolerances on flange dimensions (ASME/ANSI B16.5)

Dimension	Range	Tolerance	
		in	mm
General and Blind Flanges (For blind flange dimensions see pages 5-8/9):			
G (raised face diameter)	≤ NPS 24	±0.03	±0.76
	≥ NPS 26, with 0.06 in raised face	±0.08	±2.03
	≥ NPS 26, with 0.25 in raised face	±0.04	±1.02
I (bolt hole diameter)	All	No tolerance in B16.5 or B16.47	
J (bolt circle diameter)	All	±0.06	±1.52
Centre to centre of adjacent bolt holes	All	±0.03	±0.76
Eccentricity of bolt circle and machined facing diameters	≤ NPS 2½	±0.03	±0.76
	≥ NPS 3	±0.06	±1.52
Weld Neck Flanges <sup>1</sup> (For dimensions see pages 5-4/5):			
D (overall length)	≤ NPS 4	+0.06	+1.52
	NPS 5 to 10	+0.06, -0.12	+1.52, -3.05
	NPS 12 to 24	+0.12, -0.18	+3.05, -4.57
	≥ NPS 26	±0.19	±4.83
Thickness of hub	All	> 87.5% of pipe nominal wall thickness	
Slip on (see page 5-6/7), Lap Joint and Socket Welding Flanges:			
B (inside diameter, or bore)	≤ NPS 10	+0.03, -0.0	+0.76, -0.0
	≥ NPS 12	+0.06, -0.0	+1.52, -0.0
Threaded Flanges:			
B (counterbore) (Not applicable for Class 150 lb)	≤ NPS 10	+0.03, -0.0	+0.76, -0.0
	≥ NPS 12	+0.06, -0.0	+1.52, -0.0



BS4504 is now obsolete and has been replaced by EN 1092. However the dimensions and tolerances have not changed.

### Flange types and methods of manufacture

ISO EN	BS	Type of Flange and Collar	Forged <sup>a</sup>	Cast	Made from flat products (plates)	Machined from rolled or forged bars and forged sectional steel	Bent and electric welded from bars, sectional steel or strip <sup>b,c,d,e</sup>
01	101	Plate flange for welding	yes	no	yes	yes	yes
05	105	Blind flange	yes	no	yes	yes	no
11	111	Weld-neck flange	yes	no	no	yes	yes, for $\geq$ DN 700
12	112	Hubbed slip-on flange for welding	yes	no	no	yes	no

a Seamless rolled, pressed, forged.

b Only one radial weld is allowed under DN 1800.

c Welded flanges allowed only for an application up to 370°C in conformance with EN 13480-3:2002, D.4.4.

d In case flanges are made by cold forming of a base material e.g. flat product, some mechanical properties, like elongation after fracture (A) and impact energy (KV), will be impaired due to cold forming without subsequent heat treatment.

### Repairs by welding

With the exception of weld repairs carried out according to BSEN 1092-1:2007 (E) clause 5.11, repairs by welding are permitted only by written agreement of the purchaser.

Within the certificate for material or component relevant documents shall be noted, that approved welding procedure and welders qualification have been applied.

### Bolting

Flanges shall be suitable for use with the number and size of bolting as specified in the Tables on pages 5-14 to 5-18. The bolting shall be chosen by the equipment manufacturer according to the pressure, temperature, flange material and gasket so that the flanged joint remains tight under the expected operating conditions. For selection of bolting, see EN 1515-1, for combination of the materials of flanges and bolting see EN 1515-2, for information.

### Gaskets

The various gasket types, dimensions, design characteristics and materials used are not within the scope of this European Standard, Dimensions of gaskets are given in the series of standards EN 1514.

# Flanges

Range/Sizes - EN 1092 / (BS4504)

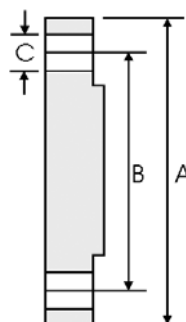

## Flange drilling details

DN	PN	A	B	C	Bolt holes	
		mm	mm	mm	No.	Size
10	10 & 16	90	60	14	4	M12
15	10 & 16	95	65	14	4	M12
20	10 & 16	105	75	14	4	M12
25	10 & 16	115	85	14	4	M12
32	10 & 16	140	100	18	4	M16
40	10 & 16	150	110	18	4	M16
50	10 & 16	165	125	18	4	M16
65	10 & 16	185	145	18	4/8	M16
80	10 & 16	200	160	18	8	M16
100	10 & 16	220	180	18	8	M16
125	10 & 16	250	210	18	8	M16
150	10 & 16	285	240	22	8	M20
200	10 & 16	340	295	22	8/12	M20
250	10	395	350	22	12	M20
	16	405	355	26	12	M24
300	10	445	400	22	12	M20
	16	460	410	26	12	M24
350	10	505	460	22	16	M20
	16	520	470	26	16	M24
400	10	565	515	26	16	M24
	16	580	525	30	16	M27
450	10	615	565	26	20	M24
	16	640	585	30	20	M27

DN	PN	A	B	C	Bolt holes	
		mm	mm	mm	No.	Size
500	10	670	620	26	20	M24
	16	715	650	33	20	M30
600	10	780	725	30	20	M27
	16	840	770	36	20	M33
700	10	895	840	30	24	M27
	16	910	840	36	24	M33
800	10	1015	950	33	24	M30
	16	1025	950	39	24	M36
900	10	1115	1050	33	28	M30
	16	1125	1050	39	28	M36
1000	10	1230	1160	36	28	M33
	16	1255	1170	42	28	M39
1200	10	1455	1380	39	32	M36
	16	1485	1390	48	32	M45
1400	10	1675	1590	42	36	M39
	16	1685	1590	48	36	M45
1600	10	1915	1820	48	40	M45
	16	1930	1820	56	40	M52
1800	10	2115	2020	48	44	M45
	16	2130	2020	56	44	M52
2000	10	2325	2230	48	48	M45
	16	2345	2230	62	48	M56

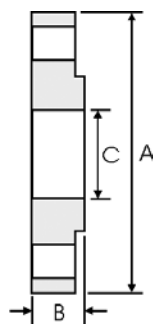

DN	PN	A	B	C
		mm	mm	mm
10	10 & 16	90	14	18.0
15	10 & 16	95	14	22.0
20	10 & 16	105	16	27.5
25	10 & 16	115	16	34.5
32	10 & 16	140	18	43.5
40	10 & 16	150	18	49.5
50	10 & 16	165	20	61.5
65	10 & 16	185	20	77.5
80	10 & 16	200	20	90.5
100	10 & 16	220	22	116.0
125	10 & 16	250	22	141.5
150	10 & 16	285	24	170.5
200	10 & 16	340	24	221.5
250	10	395	26	276.5
	16	405	29	

DN	PN	A	B	C
		mm	mm	mm
300	10	445	26	327.5
	16	460	32	
350	10	505	28	359.5
	16	520	35	359.0
400	10	565	32	411.0
	16	580	38	
450	10	615	36	462.0
	16	640	42	
500	10	670	38	513.5
	16	715	46	
600	10	780	42	616.5
	16	840	52	

### Notes

- Dimension B is the flange thickness with or without a raised face.
- For drilling details see page 5-14.
- For tolerances see page 5-19.
- For facing types and dimensions see page 5-20 and 5-21.

# Flanges

Range/Sizes - Weld Neck Flanges Code 11 (111) - EN 1092 / (BS4504)

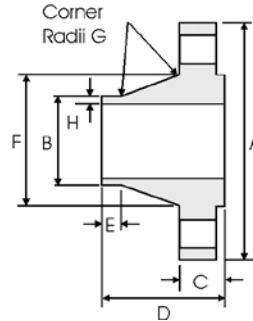

DN	PN	A	B	C	D	E	F	G	H
		mm	mm	mm	mm	mm	mm	mm	mm
10	10	90	17.2	14	35	6	28	3	1.8
	16	90		14	35		28		1.8
15	10	95	21.3	14	35	6	32	3	2
	16	95		14	35		32		2
20	10	105	26.9	16	38	6	39	4	2.3
	16	105		16	38		39		2.3
25	10	115	33.7	16	38	6	46	4	2.6
	16	115		16	38		46		2.6
32	10	140	42.4	16	40	6	56	5	2.6
	16	140		16	40		56		2.6
40	10	150	48.3	16	42	7	64	5	2.6
	16	150		16	42		64		2.6
50	10	165	60.3	18	45	8	74	5	2.9
	16	165		18	45		74		2.9
65	10	185	76.1	18	45	10	92	6	2.9
	16	185		18	45		92		2.9
80	10	200	88.9	20	50	10	110	6	3.2
	16	200		20	50		110		3.2
100	10	220	114.3	20	52	12	130	6	3.6
	16	220		20	52		130		3.6
125	10	250	139.7	22	55	12	158	6	4
	16	250		22	55		158		4
150	10	285	168.3	22	55	12	184	8	4.5
	16	285		22	55		184		4.5
200	10	340	219.1	24	62	16	234	8	5.6
	16	340		24	62		234		5.6
250	10	395	273	26	68	16	288	10	6.3
	16	405		26	70		288		6.3
300	10	445	323.9	26	68	16	342	10	7.1
	16	460		28	78		342		7.1

DN	PN	A	B	C	D	E	F	G	H
		mm	mm	mm	mm	mm	mm	mm	mm
350	10	505	355.6	26	68	16	390	10	7.1
	16	520		30	82		390		8
400	10	565	406.4	26	72	16	440	10	7.1
	16	580		32	85		444		8
450	10	615	457	28	72	16	488	12	7.1
	16	640		34	87		490		8
500	10	670	508	28	75	16	540	12	7.1
	16	715		34	90		546		8
600	10	780	610	28	80	18	640	12	7.1
	16	840		36	95		650		8.8
700	10	895	711	30	80	18	746	12	8
	16	910		36	100		750		8.8
800	10	1015	813	32	90	18	848	12	8
	16	1025		38	105		848		10
900	10	1115	914	34	95	20	948	12	10
	16	1125		40	110		948		10
1000	10	1230	1016	34	95	20	1050	12	10
	16	1255		42	120		1056		10
1200	10	1455	1220	38	115	25	1256	12	11
	16	1485		48	130		1260		12.5
1400	10	1675	1420	42	120	25	1460	12	12
	16	1685		52	145		1465		14.2
1600	10	1915	1620	46	130	25	1666	12	14
	16	1930		58	160		1668		16
1800	10	2115	1820	50	140	30	1866	15	15
	16	2130		62	170		1870		17.5
2000	10	2325	2020	54	150	30	2070	15	16
	16	2345		66	190		2072		20

**Notes**

- For drilling details see page 5-14.
- For tolerances see page 5-19.
- For facing types and dimensions see pages 5-20 and 5-21.

## Range/Sizes - Slip On Flanges Code 12 (112) - EN 1092 / (BS4504)

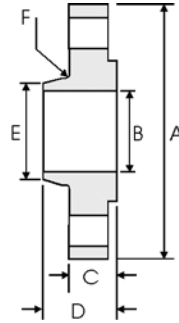

DN	PN	A	B	C	D	E	F
		mm	mm	mm	mm	mm	mm
10	10 & 16	90	18.0	14	20	30	3
15	10 & 16	95	22	14	20	35	3
20	10 & 16	105	27.5	16	24	45	4
25	10 & 16	115	34.5	16	24	52	4
32	10 & 16	140	43.5	16	26	60	5
40	10 & 16	150	49.5	16	26	70	5
50	10 & 16	165	61.5	18	28	84	5
65	10 & 16	185	77.5	18	32	104	6
80	10 & 16	200	90.5	20	34	118	6
100	10 & 16	220	116.0	20	40	140	6
125	10 & 16	250	141.5	22	44	168	6
150	10 & 16	285	170.5	22	44	195	8
200	10 & 16	340	221.5	24	44	246	8
250	10	395	276.5	26	46	298	10
	16	405		26	46	298	

DN	PN	A	B	C	D	E	F
		mm	mm	mm	mm	mm	mm
300	10	445	327.5	26	46	350	10
	16	460		28	46	350	
350	10	505	359.5	26	53	400	10
	16	520	359.0	30	57	400	
400	10	565	411.0	26	57	456	10
	16	580		32	63	456	
450	10	615	462.0	28	63	502	12
	16	640		34	68	502	
500	10	670	513.5	28	67	559	12
	16	715		34	73	559	
600	10	780	616.5	28	75	658	12
	16	840		36	83	658	

### Notes

- The hubs of slip on (Code 12) flanges are parallel or have a draft <7 degrees.
- For drilling details see page 5-14.
- For tolerances see page 5-19.
- For facing types and dimensions see pages 5-20 and 5-21.

# Flanges

Range/Sizes - Blank/Blind Flanges Code 05 (105) - EN 1092 / (BS4504)

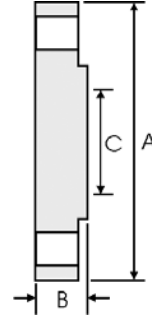

DN	PN	A	B	C
		mm	mm	mm
10	10 & 16	90	14	-
15	10 & 16	95	14	-
20	10 & 16	105	16	-
25	10 & 16	115	16	-
32	10 & 16	140	16	-
40	10 & 16	150	16	-
50	10 & 16	165	18	-
65	10 & 16	185	18	55
80	10 & 16	200	20	70
100	10 & 16	220	20	90
125	10 & 16	250	22	115
150	10 & 16	285	22	140
200	10 & 16	340	24	190
250	10	395	26	235
	16	405	26	235
300	10	445	26	285
	16	460	28	285
350	10	505	26	325
	16	520	30	325

DN	PN	A	B	C
		mm	mm	mm
400	10	565	26	375
	16	580	32	375
450	10	615	28	425
	16	640	34	425
500	10	670	28	475
	16	715	36	475
600	10	780	34	575
	16	840	44	575
700	10	895	38	670
	16	910	48	670
800	10	1015	42	770
	16	1025	52	770
900	10	1115	46	860
	16	1125	58	860
1000	10	1230	52	960
	16	1255	64	960
1200	10	1455	60	1160
	16	1485	76	1160

**Notes**

- Dimension B is the range thickness with or without a raised face.
- Dimension C is the maximum diameter of the centre portion of a blank flange face which need not be machined.
- For drilling details see page 5-14.
- For tolerances see page 5-19.
- For facing types and dimensions see pages 5-20 and 5-21.

### Dimensions and tolerances

Dimension		Range	Tolerance
			mm
Flange Facings (see page 5-20 and 5-21)	Eccentricity of machined facing diameters	≤ DN 100	1.0
		> DN 100	2.0
	a (type B facing height)	2mm	+0, -1.0
		3mm	+0, -2.0
		4mm	+0, -3.0
		5mm	+0, -4.0
		6mm	+0, -5.0
	b (type C and E facing height)	All	+0.5, -0
	b (type G facing height)	All	+0, -0.5
	b (type H facing height, outer)	All	+0.2, -0
c (type D and F facing height)	All	+0, -0.5	
d (type H facing height, inner)	All	+0.5, -0	
B and E (facing diameters)	All	+0, -0.5	
C and D (facing diameters)	All	+0.5, -0	
Surface Finish	Facing types A, B, E and F	All, turning	Ra = 3.2 µm min, 12.5 µm max
		All, other than turning	Ra = 3.2 µm min, 6.3 µm max
	Facing types C, D, G and H	All	Ra = 0.8 µm min, 3.2 µm max
Flange Drilling Details (see page 5-14)	B (diameter of bolt circle)	Bolt sizes M10 to M24	±0.9
		Bolt sizes M27 to M45	±1.4
	Centre to centre of adjacent bolt holes	Bolt sizes M10 to M24	±0.45
		Bolt sizes M27 to M45	±0.7
All	A (outside diameter)	≤ DN 150	±2.0
		> DN 150 ≤ DN 500	±3.0
		> DN 500 ≤ DN 1200	±5.0
		> DN 1200 ≤ DN 1800	±7.0
		> DN 1800	±10.0
	C (flange thickness, machined on both faces)	≤ 18mm thickness	±1.0
		> 18mm ≤ 50mm thickness	±1.0
		> 50mm thickness	±1.0
	C (flange thickness, machined on front face)	≤ 18mm thickness	+2.0, -1.0
		> 18mm ≤ 50mm thickness	+4.0, -1.5
> 50mm thickness		+7.0, -2.0	
Weld Neck Flanges, Code 11 (see page 5-16)	B (outside diameter of hub at welding end)	≤ DN 125	+3.0, -0
		> DN 125 ≤ DN 1200	+4.5, -0
		> DN 1200	+6.0, -0
	F (hub diameter)	≤ DN 50	+0, -2.0
		> DN 50 ≤ DN 150	+0, -4.0
		> DN 150 ≤ DN 300	+0, -6.0
		> DN 300 ≤ DN 600	+0, -8.0
		> DN 600 ≤ DN 1200	+0, -10.0
	D (length through hub)	≤ DN 80	±1.5
> DN 80 ≤ DN 250		±2.0	
> DN 250		±3.0	
Slip on, Code 12 (see page 5-17) and Threaded, Code 13 Flanges	E (slip on flange hub diameter) B (threaded flange hub diameter)	≤ DN 50	+1.0, -0
		> DN 50 ≤ DN 150	+2.0, -0
		> DN 150 ≤ DN 300	+4.0, -0
		> DN 300 ≤ DN 600	+8.0, -0
		> DN 600 ≤ DN 1200	+12.0, -0
		> DN 1200 ≤ DN 1800	+16.0, -0
		> DN 1800	+20.0, -0
	B (slip on bore diameter)	< DN 100	+0.5, -0
		> DN 100 ≤ DN 400	+1.0, -0
		> DN 400 ≤ DN 600	+1.5, -0
D (length through hub)	> DN 600	+3.0, -0	
Blank Flanges, Code 05 (see page 5-18)	B (flange thickness)	Same as C for all other flanges	
	C (unmachined centre portion)	Maximum specified	

# Flanges

## Specifications - EN 1092 (BS4504)

### Flange facings

EN 1092 (BS4504) flange facing types A to H are defined below. The dimensions vary with pipe size (DN) and pressure rating (PN) as detailed in the table on page 5-21.

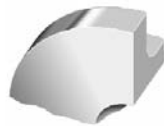

Type A  
Flat face



Type B  
Raised face

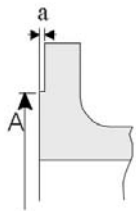

Type C  
Tongue face

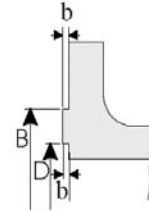

Type D  
Groove face

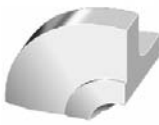
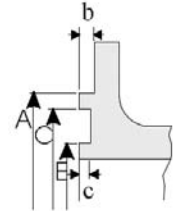

Type E  
Spigot

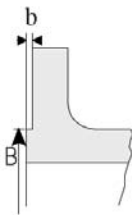

Type F  
Recess

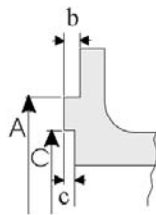

Type G  
'O' Ring recess

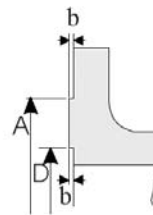

Type H  
'O' Ring groove

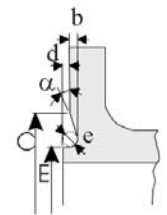



### Flange facing dimensions

DN	PN 10	PN 16	Face Dimensions									
	A		B	C	D	E	a	b	c	d	$\alpha$	e
	mm	mm	mm	mm	mm	mm	mm	mm	mm	mm	mm	mm
10	40	40	34	35	24	23	2	4	3	2	-	5
15	45	45	39	40	29	28	2	4	3	2	-	5
20	58	58	50	51	36	35	2	4	3	2	41°16'	5
25	68	68	57	58	43	42	2	4	3	2	41°16'	5
32	78	78	65	66	51	50	2	4	3	2	41°16'	5
40	88	88	75	76	61	60	3	4	3	2	41°16'	5
50	102	102	87	88	73	72	3	4	3	2	41°16'	5
65	122	122	109	110	95	94	3	4	3	2	41°16'	5
80	138	138	120	121	106	105	3	4	3	2	41°16'	5
100	158	158	149	150	129	128	3	4.5	3.5	2.5	32°15'	6
125	188	188	175	176	155	154	3	4.5	3.5	2.5	32°15'	6
150	212	212	203	204	183	182	3	4.5	3.5	2.5	32°15'	6
200	268	268	259	260	239	238	3	4.5	3.5	2.5	32°15'	6
250	320	320	312	313	292	291	3	4.5	3.5	2.5	32°15'	6
300	370	378	363	364	343	342	4	4.5	3.5	2.5	32°15'	6
350	430	438	421	422	395	394	4	5	4	3	27°24'	7
400	482	490	473	474	447	446	4	5	4	3	27°24'	7
450	532	550	523	524	497	496	4	5	4	3	27°24'	7
500	585	610	575	576	549	548	4	5	4	3	27°24'	7
600	685	725	675	676	649	648	5	5	4	3	27°24'	7
700	800	795	777	778	751	750	5	5	4	3	27°24'	7
800	905	900	882	883	856	855	5	5	4	3	27°24'	7
900	1005	1000	987	988	961	960	5	5	4	3	27°24'	7
1000	1110	1115	1092	1094	1062	1060	5	6	5	4	28°39'	8
1200	1330	1330	1292	1294	1262	1260	5	6	5	4	28°39'	8
1400	1535	1530	1492	1494	1462	1460	5	6	5	4	28°39'	8
1600	1760	1750	1692	1694	1662	1660	5	6	5	4	28°39'	8
1800	1960	1950	1982	1894	1862	1860	5	6	5	4	28°39'	8
2000	2170	2150	2092	2094	2062	2060	5	6	5	4	28°39'	8

# Flanges

## Range/Sizes/Specifications - EN 1092 (BS4504)

### Masses of flanges PN 16

DN	Type 01	Type 05	Type 11	Type 12
	kg	kg	kg	kg
10	0.604	0.722	0.678	0.646
15	0.670	0.813	0.768	0.722
20	0.936	1.14	1.09	1.04
25	1.11	1.38	1.30	1.25
32	1.82	2.03	1.91	1.81
40	2.08	2.35	2.15	2.06
50	2.73	2.88	2.53	2.39
65	3.16 <sup>1</sup>	3.51 <sup>1</sup>	3.03 <sup>1</sup>	2.97 <sup>1</sup>
80	3.60	4.61	3.92	3.78
100	4.39	5.65	4.62	4.38
125	5.41	8.13	6.30	6.07
150	7.14	10.5	7.81	7.24
200	9.73	16.2	11.5	9.80
250	14.2	25.0	16.7	13.6
300	19.0	35.1	22.1	17.2
350	28.2	48.0	32.8	27.9
400	35.9	63.5	41.1	35.7
450	46.1	96.6	50.6	45.0
500	64.0	133	66.2	60.4
600	102	226	96.5	94.0
700	-	285	104	-
800	-	388	122	-
900	-	483	155	-
1000	-	640	233	-
1200	-	-	390	-
1400	-	-	495	-
1600	-	-	760	-
1800	-	-	929	-
2000	-	-	1185	-

<sup>1</sup> With 8 bolt holes.

## Range/Sizes/Specifications - BS10 Plate Flanges

British Standard BS 10 : 1962 - Specification for Flanges and Bolting for Pipes, Valves, and Fittings. This covers plain, boss, integrally cast or forged, and welding neck type flanges, in ten tables. Although BS 10 is obsolescent, it remains in use for the dimensions of light duty, economy stainless steel flanges in applications where corrosion resistance and/or hygiene, rather than high pressures and temperatures, are the primary considerations. The following tables detail the applicable standard dimensions from Tables D, E, F and H of BS 10.

### Flange dimensions based on tables D and E of BS 10 : 1962

Common Flange Size Designation (Nominal Bore of Pipe)	BS 10 Table D Dimensions					BS 10 Table E Dimensions				
	Overall Diameter of Flange	Flange Thickness	Bolt Circle Diameter	Number of Bolts	Diameter of Bolts	Overall Diameter of Flange	Flange Thickness	Bolt Circle Diameter	Number of Bolts	Diameter of Bolts
in	in	in	in		in	in	in	in		in
1/2	3 <sup>3</sup> / <sub>4</sub>	3 <sup>1</sup> / <sub>16</sub>	2 <sup>5</sup> / <sub>8</sub>	4	1/2	3 <sup>3</sup> / <sub>4</sub>	1/4	2 <sup>5</sup> / <sub>8</sub>	4	1/2
3/4	4	3 <sup>1</sup> / <sub>16</sub>	2 <sup>7</sup> / <sub>8</sub>	4	1/2	4	1/4	2 <sup>7</sup> / <sub>8</sub>	4	1/2
1	4 <sup>1</sup> / <sub>2</sub>	3 <sup>1</sup> / <sub>16</sub>	3 <sup>1</sup> / <sub>4</sub>	4	1/2	4 <sup>1</sup> / <sub>2</sub>	9 <sup>3</sup> / <sub>32</sub>	3 <sup>1</sup> / <sub>4</sub>	4	1/2
1 <sup>1</sup> / <sub>4</sub>	4 <sup>3</sup> / <sub>4</sub>	1/4	3 <sup>7</sup> / <sub>16</sub>	4	1/2	4 <sup>3</sup> / <sub>4</sub>	5 <sup>1</sup> / <sub>16</sub>	3 <sup>7</sup> / <sub>16</sub>	4	1/2
1 <sup>1</sup> / <sub>2</sub>	5 <sup>1</sup> / <sub>4</sub>	1/4	3 <sup>7</sup> / <sub>8</sub>	4	1/2	5 <sup>1</sup> / <sub>4</sub>	11 <sup>1</sup> / <sub>32</sub>	3 <sup>7</sup> / <sub>8</sub>	4	1/2
2	6	5 <sup>1</sup> / <sub>16</sub>	4 <sup>1</sup> / <sub>2</sub>	4	5/8	6	3/8	4 <sup>1</sup> / <sub>2</sub>	4	5/8
2 <sup>1</sup> / <sub>2</sub>	6 <sup>1</sup> / <sub>2</sub>	5 <sup>1</sup> / <sub>16</sub>	5	4	5/8	6 <sup>1</sup> / <sub>2</sub>	13 <sup>3</sup> / <sub>32</sub>	5	4	5/8
3	7 <sup>1</sup> / <sub>4</sub>	3/8	5 <sup>3</sup> / <sub>4</sub>	4	5/8	7 <sup>1</sup> / <sub>4</sub>	7 <sup>1</sup> / <sub>16</sub>	5 <sup>3</sup> / <sub>4</sub>	4	5/8
3 <sup>1</sup> / <sub>2</sub>	8	3/8	6 <sup>1</sup> / <sub>2</sub>	4	5/8	8	15 <sup>3</sup> / <sub>32</sub>	6 <sup>1</sup> / <sub>2</sub>	8	5/8
4	8 <sup>1</sup> / <sub>2</sub>	3/8	7	4	5/8	8 <sup>1</sup> / <sub>2</sub>	1/2	7	8	5/8
5	10	1/2	8 <sup>1</sup> / <sub>4</sub>	8	5/8	10	9 <sup>1</sup> / <sub>16</sub>	8 <sup>1</sup> / <sub>4</sub>	8	5/8
6	11	1/2	9 <sup>1</sup> / <sub>4</sub>	8	5/8	11	11 <sup>1</sup> / <sub>16</sub>	9 <sup>1</sup> / <sub>4</sub>	8	3/4
7	12	1/2	10 <sup>1</sup> / <sub>4</sub>	8	5/8	12	3/4	10 <sup>1</sup> / <sub>4</sub>	8	3/4
8	13 <sup>1</sup> / <sub>4</sub>	1/2	11 <sup>1</sup> / <sub>2</sub>	8	5/8	13 <sup>1</sup> / <sub>4</sub>	3/4	11 <sup>1</sup> / <sub>2</sub>	8	3/4
9	14 <sup>1</sup> / <sub>2</sub>	5/8	12 <sup>3</sup> / <sub>4</sub>	8	5/8	14 <sup>1</sup> / <sub>2</sub>	13 <sup>1</sup> / <sub>16</sub>	12 <sup>3</sup> / <sub>4</sub>	12	3/4
10	16	5/8	14	8	3/4	16	7/8	14	12	3/4
12	18	3/4	16	12	3/4	18	1	16	12	7/8
13	19 <sup>1</sup> / <sub>4</sub>	3/4	17 <sup>1</sup> / <sub>4</sub>	12	3/4	19 <sup>1</sup> / <sub>4</sub>	1	17 <sup>1</sup> / <sub>4</sub>	12	7/8
14	20 <sup>3</sup> / <sub>4</sub>	7/8	18 <sup>1</sup> / <sub>2</sub>	12	7/8	20 <sup>3</sup> / <sub>4</sub>	1 <sup>1</sup> / <sub>8</sub>	18 <sup>1</sup> / <sub>2</sub>	12	7/8
15	21 <sup>3</sup> / <sub>4</sub>	7/8	19 <sup>1</sup> / <sub>2</sub>	12	7/8	21 <sup>3</sup> / <sub>4</sub>	1 <sup>1</sup> / <sub>4</sub>	19 <sup>1</sup> / <sub>2</sub>	12	7/8
16	22 <sup>3</sup> / <sub>4</sub>	7/8	20 <sup>1</sup> / <sub>2</sub>	12	7/8	22 <sup>3</sup> / <sub>4</sub>	1 <sup>1</sup> / <sub>4</sub>	20 <sup>1</sup> / <sub>2</sub>	12	7/8
17	24	1	21 <sup>3</sup> / <sub>4</sub>	12	7/8	24	1 <sup>3</sup> / <sub>8</sub>	21 <sup>3</sup> / <sub>4</sub>	12	7/8
18	25 <sup>1</sup> / <sub>4</sub>	1	23	12	7/8	25 <sup>1</sup> / <sub>4</sub>	1 <sup>3</sup> / <sub>8</sub>	23	16	7/8
19	26 <sup>1</sup> / <sub>2</sub>	1	24	12	7/8	26 <sup>1</sup> / <sub>2</sub>	1 <sup>1</sup> / <sub>2</sub>	24	16	7/8
20	27 <sup>3</sup> / <sub>4</sub>	1 <sup>1</sup> / <sub>8</sub>	25 <sup>1</sup> / <sub>4</sub>	16	7/8	27 <sup>3</sup> / <sub>4</sub>	1 <sup>1</sup> / <sub>2</sub>	25 <sup>1</sup> / <sub>4</sub>	16	7/8
21	29	1 <sup>1</sup> / <sub>8</sub>	26 <sup>1</sup> / <sub>2</sub>	16	7/8	29	1 <sup>5</sup> / <sub>8</sub>	26 <sup>1</sup> / <sub>2</sub>	16	1
22	30	1 <sup>1</sup> / <sub>8</sub>	27 <sup>1</sup> / <sub>2</sub>	16	1	30	1 <sup>3</sup> / <sub>4</sub>	27 <sup>1</sup> / <sub>2</sub>	16	1
23	31	1 <sup>1</sup> / <sub>8</sub>	28 <sup>1</sup> / <sub>2</sub>	16	1	31	1 <sup>3</sup> / <sub>4</sub>	28 <sup>1</sup> / <sub>2</sub>	16	1
24	32 <sup>1</sup> / <sub>2</sub>	1 <sup>1</sup> / <sub>4</sub>	29 <sup>3</sup> / <sub>4</sub>	16	1	32 <sup>1</sup> / <sub>2</sub>	1 <sup>7</sup> / <sub>8</sub>	29 <sup>3</sup> / <sub>4</sub>	16	1 <sup>1</sup> / <sub>8</sub>

#### Notes

- Bolt hole diameters are as follows:

For 1/2 in and 5/8 in bolts, the bolt hole shall be 1/16 in larger than the bolt diameter.

For 3/4 in bolts and larger, the bolt hole shall be not more than 1/8 in larger than the bolt diameter.

# Hygienics

## Introduction/Tube Range

**Stainless Steel Hygienics is the name given to a range of tube and fittings used in applications requiring a clean and sanitary flow of liquids and where it is essential to avoid contamination of the products being carried. These applications cover the food processing, beverage, biotech and pharmaceutical industries including breweries and dairies.**

- ◊ The applications are low pressure with a maximum of 150lbs.
- ◊ The products are available in grades 304L and-316L.
- ◊ The size range is from 1/2 inch to 4 inch O/D.
- ◊ The tube and fittings are of welded construction with the internal bead rolled to flatten it and eliminate crevices, thus preventing interruptions to the flow and eliminating the risk of contamination or bug traps as well as facilitate easy cleaning.
- ◊ The tube and fittings are offered with a choice of external finishes:
  - Descaled
  - Bright Annealed
  - Dull Polished
  - Semi-Bright or Bright Polished.

### Manufacturing standards

- ◊ Hygienic tubes are manufactured to ASTM A270, DIN 11850, ISO 2037 and BS 4825 Part 1.
- ◊ Hygienic fittings are manufactured to BS 4825 Parts 2 to 5.

### Markings on tube and fittings

Tube and fittings with a bright annealed or polished finish will be unmarked.

## Range/Sizes - Tube

### Sizes to ASTM A270

O/D	Wall		Weight
	in	mm	
<sup>3</sup> / <sub>4</sub>	16	1.63	0.70
1	16	1.63	0.99
1½	16	1.63	1.51
2	16	1.63	1.88
2½	16	1.63	2.49
3	16	1.63	3.01
4	16	1.63	4.03
4	14	2.03	4.98

### Sizes to DIN 11850

O/D	Wall	Weight
in	mm	kg/m
1	1.5	0.90
1½	1.5	1.38
2	1.5	1.85
2½	1.5	2.34
3	1.5	2.81
4	2.0	5.02

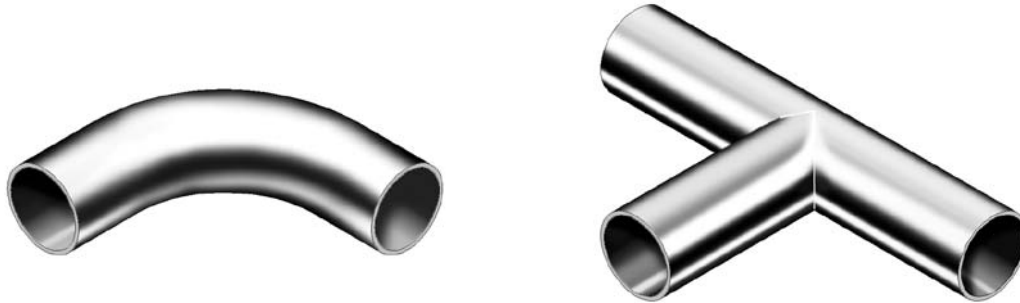

There are two types of bends and tees available, the Short type and Long type. For bends, the Short type simply comprises a 90° bend, while the Long type has a straight leg added at both ends. Tees have equivalent dimensions making them interchangeable. The straight leg of long type bends and tees was originally added to enable expanded type clamp and union parts to be fitted, but they are now widely used in all-welded installations.

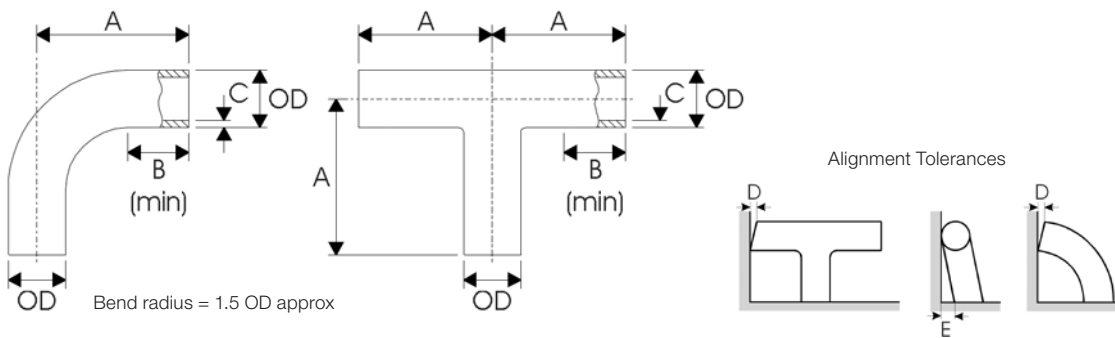

### Dimensions and tolerances

OD	Short Type			Long Type			Max Deviation	
	A	B	C	A	B	C	D	E
mm	mm	mm	mm	mm	mm	mm	mm	mm
12.7	-	-	-	45	25	1.2	0.1	0.2
15.88	-	-	-	55	25	1.2	0.2	0.4
19.05	-	-	-	60	25	1.2	0.2	0.4
25.4	43.5	25	1.6	65	25	1.6 (or 1.2 <sup>1</sup> )	0.25	0.5
38.1	63.5	25	1.6	85	25	1.6 (or 1.2 <sup>1</sup> )	0.3	0.6
50.8	88.5	30	1.6	110	30	1.6 (or 1.2 <sup>1</sup> )	0.4	0.8
63.5	113.5	35	1.6	135	35	1.6	0.5	1.0
76.2	133.5	38	1.6	155	38	1.6	0.5	1.0
101.6	173.5	38	2.0	195	38	2.0	0.7	1.4

Notes  
<sup>1</sup> The 1.2mm wall thickness is for use with expanded fittings.

◊ Length tolerances. +0.5mm, -0mm.

# Hygienics

## Clamp Fittings - BS 4825 : Part 3



Clamp fittings provide a crevice free joint and, depending on the clamp design, requires no tools for assembly or dismantling for cleaning. Provides quick method of regularly opening up a system and often has some kind of closure device such as a 'Triclover' clamp. Used where corrosion and contamination are particular hazards, as in the pharmaceutical industry. Also used in systems carrying warm semi-solids and viscous liquids, such as chocolate and tomato sauce, which must not cool in the line but tend to cause regular blockages.

Clamp fittings comprise four parts – two welding ferrules, a seal ring and a clamp. The ends of the tubes and/or fittings to be joined have a welding ferrule fitted by welding (or expansion on to expanded type parts if used). The joint is made by positioning the welding ferrules together, with a seal inserted between the faces, and then clamping the ferrules together. The clamp is not in contact with the contents of the pipe and may be made of any suitable material.

### Assembly

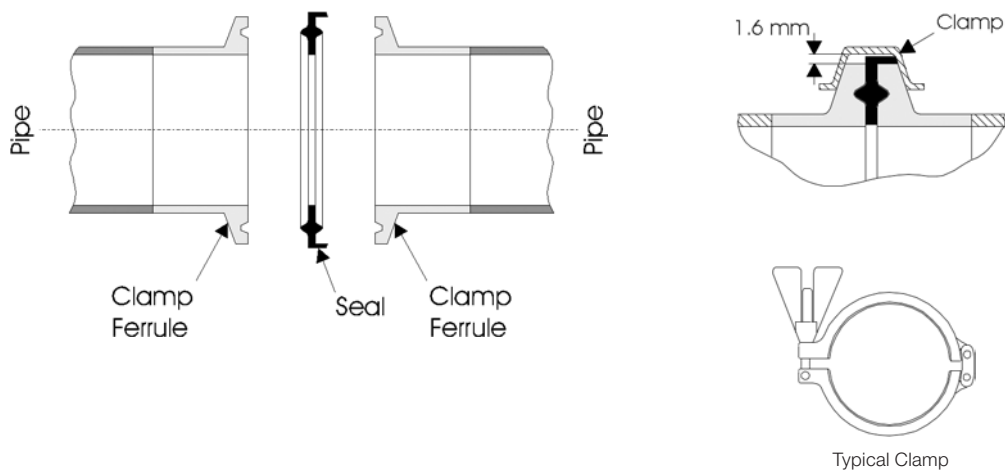

### Welding ferrule

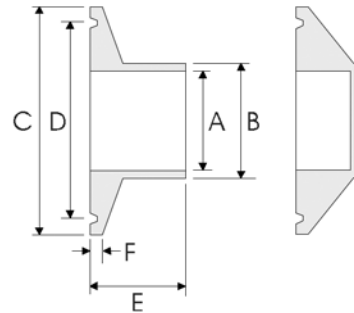

OD	A	B	C	D	E	F
mm	mm	mm	mm	mm	mm	mm
25.4	22.2	25.65	50.5	43.5	21.5	2.85
38.1	34.9	38.35	50.5	43.5	21.5	2.85
50.8	47.6	51.05	64.0	56.5	21.5	2.85
63.5	60.3	63.75	77.5	70.5	21.5	2.85
76.2	73.0	76.45	91.0	83.5	21.5	2.85
101.6	97.6	101.85	119.0	110.0	21.5	2.85

### Seals

Two types of seal are defined in BS 4825, the first for use when a joint is to be frequently disconnected and the second for use in less frequently disconnected joints. The dimensions of both types are given below:

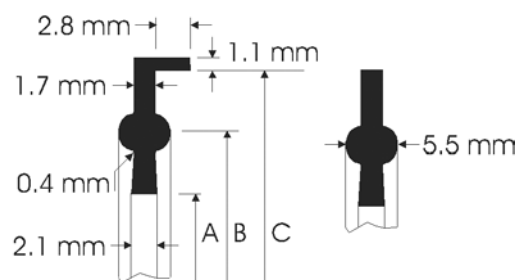
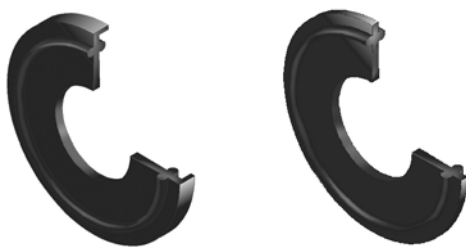

OD	A	B	C
mm	mm	mm	mm
25.4	22.8	43.5	50.5
38.1	35.5	43.5	50.5
50.8	48.2	56.5	64.0
63.5	60.5	70.5	77.5
76.2	73.2	83.5	91.0
101.6	97.8	110.0	119.0

# Hygienics

## IDF Unions - BS 4825 : Part 4



The International Dairy Federation, IDF, coupling provides a crevice free joint originally designed for applications where frequent dismantling for cleaning would not be necessary. They may be operated at pressures up to 1.6 MPa.

The Liner is machined and the Nitrile or EPDM Seal is a square section and is more substantial than the RJT. The IDF Union also has a thicker Nut than the RJT. It is machined rather than pressed and is considered easier to use.

Compared to the RJT, the IDF has a smoother and cleaner flow line that is free of crevices and bug traps. It is used where CIP (Clean In Place) systems prevail, with the RJT only tending to be used where very regular access is needed.

IDF type couplings comprise four parts – a male part, a liner, a seal ring and a hexagonal or round nut. The ends of the tubes and/or fittings to be joined have a male part and liner fitted by welding (or expansion on to expanded type parts if used). The joint is made by positioning the male part and the liner together, with a seal inserted between. The nut is then slipped over the liner, screwed on to the male part and tightened against the liner to compress the seal.

BS 4825 : Part 3 requirements for IDF union parts follow.

### Assembly

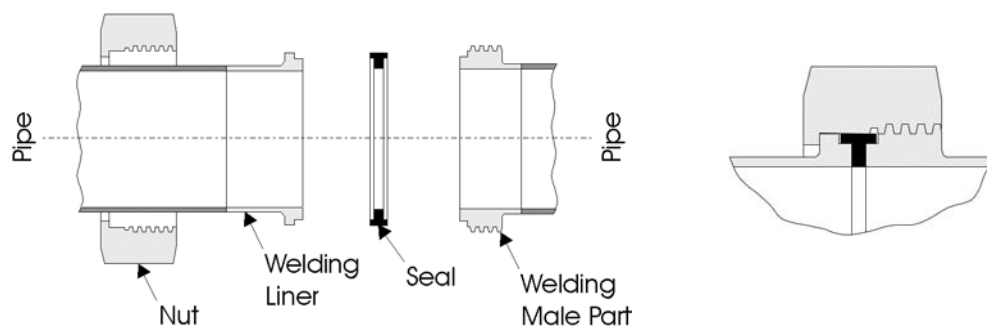

The illustration above shows the assembly of an IDF union with welded parts.

Options:

- ◊ Expanded IDF expanded type union parts are available.
- ◊ Round nuts. True IDF round nuts have no slots on their circumference, making them tamper proof, but necessitating the use of a special spanner.



### Welding male part (threaded)

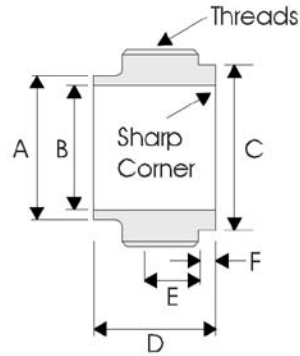

Notes  
- An ACME form thread is used.

OD	A	B	C	D	E	F
mm	mm	mm	mm	mm	mm	mm
25.4	25.65	22.2	29.2	21.5	13.5	3.0
38.1	38.35	34.9	42.7	21.5	13.5	3.0
50.8	51.05	47.6	56.2	21.5	13.5	3.0
63.5	63.75	60.3	69.9	21.5	13.5	3.0
76.2	76.45	73.0	82.6	21.5	13.5	3.0
101.6	101.85	97.6	111.1	30.0	16.0	3.2

### Welding liner

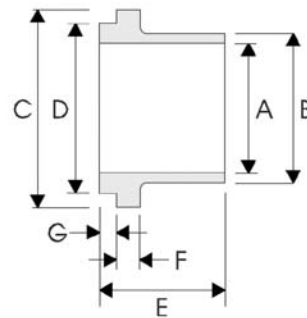

OD	A	B	C	D	E	F	G
mm	mm	mm	mm	mm	mm	mm	mm
25.4	22.2	25.65	33.8	29.2	21.5	4.0	3.0
38.1	34.9	38.35	47.0	42.7	21.5	4.0	3.0
50.8	47.6	51.05	60.5	56.2	21.5	4.0	3.0
63.5	60.3	63.75	74.0	69.9	21.5	4.0	3.0
76.2	73.0	76.45	87.5	82.6	21.5	4.0	3.0
101.6	97.6	101.85	120.6	111.1	30.0	4.75	3.2

# Hygienics

## IDF Unions - BS 4825 : Part 4

### Hexagonal nut

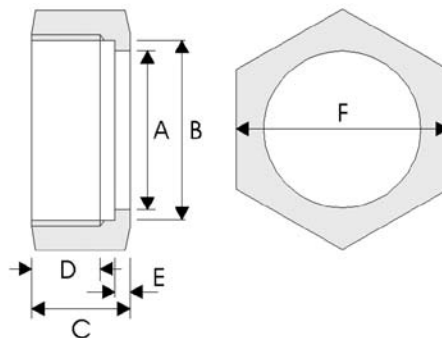

**Notes**

- An ACME form thread is used.
- A round nut may be specified.

OD	A	B	C	D	E	F
mm	mm	mm	mm	mm	mm	mm
25.4	30.5	34.34	30	16	3.5	46
38.1	43.5	47.86	30	16	3.5	60
50.8	57.0	61.37	30	16	3.5	75
63.5	70.7	74.88	30	16	3.5	90
76.2	83.3	88.40	30	16	3.5	105
101.6	112.0	122.00	35	20	4.7	133

### Seals

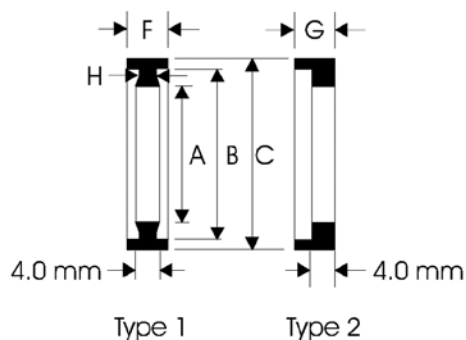

OD	A	B	C	F	G	H
mm	mm	mm	mm	mm	mm	mm
25.4	23.2	29.2	32.5	7.0	6.0	3.0
38.1	35.9	42.7	46.0	7.0	6.0	3.0
50.8	48.6	56.2	59.5	7.0	6.0	3.0
63.5	61.3	69.9	73.2	7.0	6.0	3.0
76.2	74.0	82.6	86.5	7.0	6.0	3.0
101.6	98.6	111.0	119.0	9.6	6.0	5.0

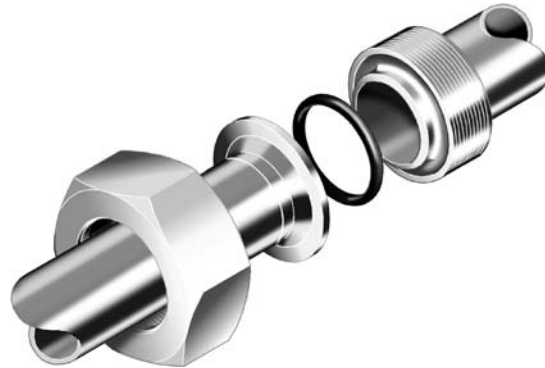

Ring Joint Type, RJT, unions are easily assembled and dismantled for cleaning purposes, this being a result of their having a Whitworth form thread. The RJT joint is not crevice free and may accumulate a deposit of the product being passed. However, present day cleaning systems are able to sanitise this area successfully without dismantling in the majority of applications. RJT unions may be operated at pressures up to 1.0 MPa.

RJT type couplings comprise four parts – a male part, a liner, an O-ring seal and a hexagonal nut. The ends of the tubes and/or fittings to be joined have a male part and liner fitted by welding (or expansion on to expanded type parts if used). The joint is made by positioning the male part and the liner together, with a seal inserted between. The nut is then slipped over the liner, screwed on to the male part and tightened against the liner to compress the seal.

BS 4825: Part 5 requirements for RJT union parts follow. Additional RJT components are also available (see page 6-11).

### Assembly

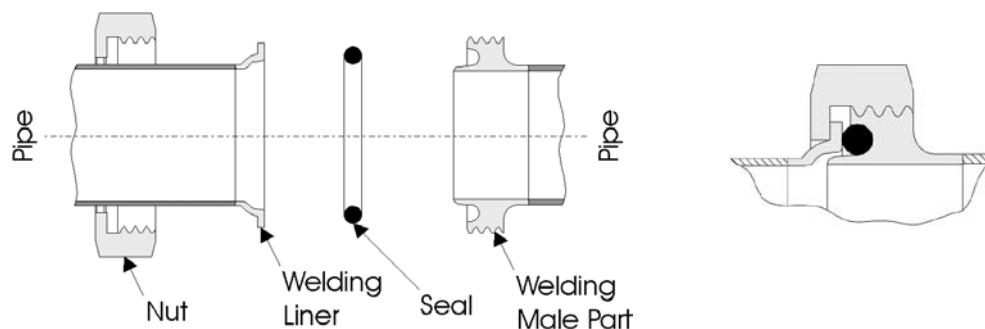

The illustration above shows the assembly of an RJT union with welded parts.

Options:

- ◊ Expanded RJT expanded type union parts are available.

# Hygienics

## RJT Unions - BS 4825 : Part 5

### Welding male part (threaded)

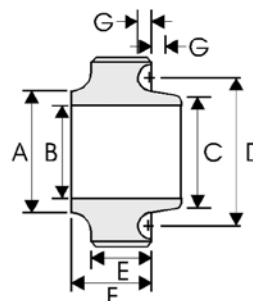

OD	A	B	C	D	E	F	G
mm	mm	mm	mm	mm	mm	mm	mm
25.4	25.65	22.2	25.4	33.3	14.3	21.5	4.8
38.1	38.35	34.9	38.1	46.0	14.3	21.5	4.8
50.8	51.05	47.6	50.8	58.7	14.3	21.5	4.8
63.5	63.75	60.3	63.5	71.4	14.3	21.5	4.8
76.2	76.45	73.0	76.2	84.1	14.3	21.5	4.8
101.6	101.85	97.6	101.6	109.5	14.3	21.5	4.8

### Welding liner

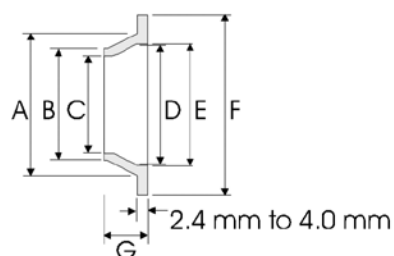

OD	A	B	C	D	E	F	G
mm	mm	mm	mm	mm	mm	mm	mm
25.4	32.5	25.65	22.2	26.2	27.8	41.3	10 or 12.7
38.1	45.2	38.35	34.9	38.9	40.5	54.0	10 or 12.7
50.8	57.9	51.05	47.6	51.6	53.2	66.7	10 or 12.7
63.5	70.6	63.75	60.3	64.3	65.9	79.4	10 or 12.7
76.2	83.3	76.45	73.0	77.0	78.6	92.1	10 or 12.7
101.6	108.5	101.85	97.6	102.4	104	117.5	12.7 or 25.4

### Hexagonal nut

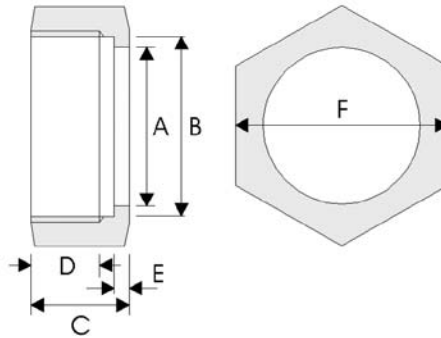

OD	A	B	C	D	E	F
mm	mm	mm	mm	mm	mm	mm
25.4	33.3	46.6	22.2	15.1	4.0	50.8
38.1	46.0	59.3	22.2	15.1	4.0	65.0
50.8	58.7	73.6	22.2	15.1	4.0	79.4
63.5	71.4	86.3	22.2	15.1	4.0	92.1
76.2	84.1	99.0	22.2	15.1	4.0	104.8
101.6	109.5	124.4	22.2	15.1	4.0	130.2

### Ring joint seals

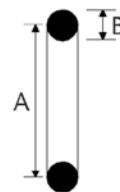

OD	A	B
mm	mm	mm
25.4	33.3	6.6
38.1	46.0	6.6
50.8	58.7	6.6
63.5	71.4	6.6
76.2	84.1	6.6
101.6	109.5	6.6

# Hygienics

## Additional Hygienic Fittings and Components

This subsection covers additional fittings and components that are compatible with the BS 4825 tube and fittings specifications.

### Pulled tees

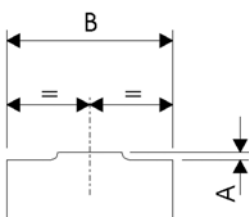

OD	A	B
mm	mm	mm
25.4	2	89
38.1	2	130
50.8	3	178
63.5	3	229
76.2	3	267
101.06	5	348

### Reducing tees

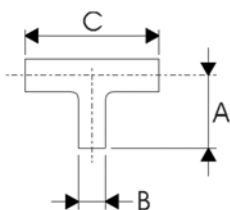

OD	A	B	C
mm	mm	mm	mm
38.1 to 25.4	38	25.4	70
50.8 to 25.4	51	25.4	82
50.8 to 38.1	51	38.1	82
63.5 to 38.1	63.5	38.1	105
63.5 to 50.8	63.5	50.8	105
76.2 to 50.8	76	50.8	110
76.2 to 63.5	76	63.5	110

### Concentric and eccentric reducers



Eccentric reducer



Concentric reducer

OD mm	Availability	
	Eccentric	Concentric
38.1 to 25.4	✓	✓
50.8 to 38.1	✓	✓
50.8 to 25.4	✓	✓
63.5 to 50.8	✓	✓
63.5 to 38.1	✓	✓
63.5 to 25.4	✓	-
76.2 to 63.5	✓	-
76.2 to 50.8	✓	✓
76.2 to 38.1	✓	✓
76.2 to 25.4	✓	✓
101.6 to 76.2	✓	✓
101.6 to 63.5	✓	-

Notes

- Dimensions are subject to agreement with purchaser

### Hinged pipe clip

Two piece hinged pipe clip tightened by an M8 knurled thumb nut and having a BSP threaded boss

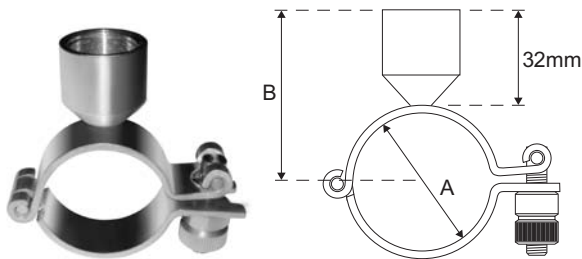

OD	A	B
in	mm	m
1/2	12.7	40
3/4	19.0	40
1	25.4	45
1 1/2	38.1	50
2	50.8	60
2 1/2	63.2	65
3	76.2	70
4	101.6	80

Notes

- Dimensions are subject to agreement with purchaser

# Hygienics

## Specifications - ASTM A270

### Seamless and welded austenitic stainless steel sanitary (hygienic) tubing

This specification covers seamless and welded austenitic stainless steel hygienic tubing having special surface finishes.

#### Dimensions and tolerances

- **Dimensions.** Tube sizes normally furnished to this specification are  $\leq 4$  in (101.6mm) OD.
- **Cut lengths** shall be no less than specified and not more than  $\frac{1}{8}$  in (3.2mm) over that specified.

#### Cross-sectional tolerances

Outside Diameter (OD)		Variations in OD				Variation in t	
		Under		Over		Under	Over
in	mm	in	mm	in	mm	%	%
$\leq 1$	$\leq 25.4$	0.005	0.13	0.005	0.13	12.5	12.5
>1 to 2	>25.4 to 50.8	0.008	0.20	0.008	0.20	12.5	12.5
>2 to 3	>50.8 to 76.2	0.010	0.25	0.010	0.25	12.5	12.5
>3 to 4	>76.2 to 101.6	0.015	0.38	0.015	0.38	12.5	12.5

Notes

- 1 For  $t < 0.049$  in (1.24mm) tolerances to be agreed with purchaser.
- 2 There are no ovality requirements.

#### Chemical composition

Grade	UNS	Composition Percentage, Max or Range								Note
		Carbon C	Manganese Mn	Phosphorus P	Sulphur S	Silicon Si	Nickel Ni	Chromium Cr	Molybdenum Mo	
TP304	S30400	0.08	2.00	0.045	0.030	1.00	8.00-11.00	18.00-20.00	-	
TP304L	S30403	0.035	2.00	0.045	0.030	1.00	8.00-12.00	18.00-20.00	-	1
TP316	S31600	0.08	2.00	0.045	0.030	1.00	10.00-14.00	16.00-18.00	2.00-3.00	
TP316L	S31603	0.035	2.00	0.045	0.030	1.00	10.00-14.00	16.00-18.00	2.00-3.00	1

Notes

- 1 Carbon 0.040% max is necessary for tubes where many drawing passes are required, as with outside diameter  $< 0.5$  in (12.7mm) or nominal wall thickness  $< 0.049$  in (1.2mm) (minimum wall thickness  $< 0.044$  in (1.12mm))

#### BS 4825 Part 1 / EN20286 - dimensions and tolerances

- **O/D Tolerance.**  $\pm 0.5\%$  or 0.1mm whichever is the greater.
- **Wall Thickness Tolerance.**  $\pm 12.5\%$ .
- **Surface Finish.** Internal 1.0Ra Maximum / External 2.5Ra Maximum.
- **Length.** For lengths up to and including 6 metres +3mm -0mm / For lengths over 6 metres +6mm -0mm.



# Metric Tube & Fittings

## Introduction/Specifications

### Stainless steel metric tubulars range

A complete range of fittings including elbows, tees, reducers, end caps, collars, backing flanges and clamps is available.

### Advantages

This ID based system brings many advantages including:

- Light weight
- Systems flexibility including ease of alteration
- Fast welding times
- Low consumables usage
- Attractive appearance
- Clean/hygienic/high-tech image
- Low environmental impact
- Recyclability
- Simple fabrication and erection
- Good mechanical properties
- Good ductility
- Low maintenance
- Long service life
- Smooth surface with no coatings or linings

### Grades

A range of grades is available from stock or on fast-track production:

BSEN 1.4307 (304L)

BSEN 1.4404 (316L)

BSEN 1.4432 (316L High Molybdenum)

Sizes shown throughout are the most popular. Many more are available, please contact your local Aalco service centre for details.

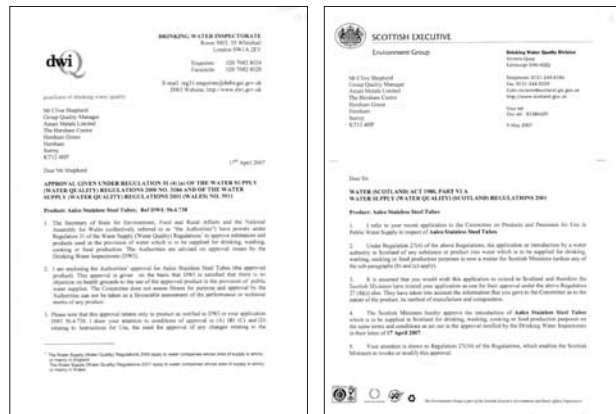

Approved for use in public water supplies

## Specifications

### ◦ Dimensional tolerances to EN/ISO 1127

- **Outside Diameter (Class D3):**  $\pm 0.75\%$  / minimum  $\pm 0.3\text{mm}$
- **Outside Diameter for tubes 168.3mm O/D & above (Class D2):**  $\pm 1.0\%$  / minimum  $\pm 0.5\text{mm}$
- **Wall Thickness (Class T3):**  $\pm 10\%$  / minimum  $\pm 0.15\text{mm}$

### ◦ Lengths

- 6 metre random lengths with plain ends.

### ◦ Finish

- Unannealed, Pickled.

# Metric Tube & Fittings

## Range/Sizes - Metric Tube

### Metric tube sizes

DN	OD	Weight per metre (kg) for given Wall Thickness in mm					
		1.5mm	2.0mm	2.5mm	3.0mm	4.0mm	5.0mm
15	18	0.620					
15	20	0.695	0.901				
20	23	0.808					
20	25	0.883					
25	28	0.995					
25	30	1.070	1.402				
25	32	1.146					
32	35	1.258					
32	38	1.371	1.803				
32	40		1.903				
40	43	1.559					
40	44.5		2.128				
50	51	1.859	2.454				
50	53	1.934					
50	54		2.604				
65	68	2.498					
65	69		3.355				
65	70		3.405				
75	78	2.870					
80	83	3.061					
80	84		4.107				
100	103	3.812					
100	104		5.108				
100	106				7.737		
100	108					10.417	
125	128	4.751					
125	129		6.360				
150	153	5.690					
150	154		7.612				
150	156				11.493		
150	158					15.425	
200	203	7.568					
200	204		10.116				
200	205			12.677			
200	206				15.249		
200	208					20.433	
250	254		12.620				
250	255			15.807			
250	256				19.005		
300	304		15.214				
300	305			18.937			
300	306				22.761		
300	308					30.449	
350	355			22.067			
350	356				26.517		
400	406				30.273		
400	408					40.465	
450	456				34.029		
500	506				37.785		
500	508					50.481	
600	606				45.297		
600	608					60.497	

# Metric Tube & Fittings

## Range/Sizes - Metric Elbows

### Welded 45° & 90° elbows (radius D+100)

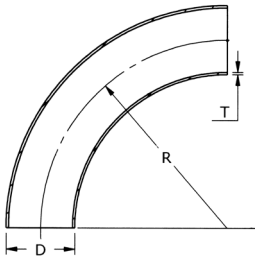

Data refers to 90° Bends only.  
45° Bends in sizes below DN200  
are cut from 90°s

### Welded 45° & 90° elbows (radius 1.5D)

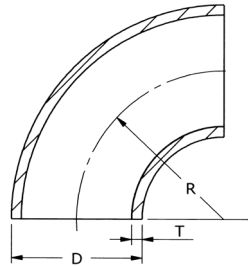

Data refers to 90° Bends only.  
45° Bends in sizes below DN200  
are cut from 90°s

D DN	OD	T Wall	Weight
mm	mm	mm	kg
25	30	2	0.27
40	44.5	2	0.46
50	54	2	0.61
65	69	2	0.90
80	84	2	1.16
100	104	2	1.61
100	106	3	2.43
125	129	2	2.25
125	131	3	3.40
150	154	2	2.99
	156	3	4.51
200	204	2	4.77
	205	2.5	5.97
	206	3	7.19
250	254	2	6.94
	255	2.5	8.69
	256	3	10.45
300	304	2	9.52
	305	2.5	11.90
	306	3	14.30
350	355	2.5	15.62
	356	3	18.74
400	406	3	23.78
450	456	3	29.40
500	506	3	35.61
	508	4	47.57
600	606	3	49.90
	608	4	66.52
700	708	4	88.60
	710	5	101.91

D DN	OD	T Wall	Weight
mm	mm	mm	kg
15	18	1.5	0.030
20	23	1.5	0.050
25	28	1.5	0.060
32	38	2	0.140
40	44.5	2	0.220
50	54	2	0.320
65	69	2	0.450
80	84	2	0.770
	86	3	1.180
100	104	2	1.200
	106	3	1.820
125	129	2	1.880
150	154	2	2.690
	156	3	4.060
200	204	2	4.770
	205	2.5	5.970
	206	3	7.190
250	254	2	7.430
	256	3	11.190
300	304	2	10.710
	306	3	16.090
350	356	3	22.500
400	406	3	29.040
	408	4	38.620
450	456	3	36.760
500	506	3	45.400
	508	4	60.420
	510	5	75.370
600	606	3	65.420
	608	4	87.080

45° & 90° elbows (radius 3D) are also available on request

# Metric Tube & Fittings

## Range/Sizes - Metric Tees

### Pulled equal tees

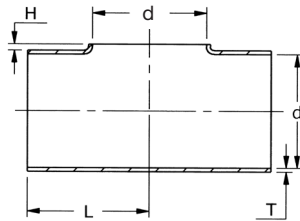

DN	d OD	T Wall	L	H	Weight
mm	mm	mm	mm*	mm*	kg
25	28	1.5	28.5	15.5	0.05
32	38	1.5	47.5	20.5	0.13
40	44	2	47.5	24	0.14
50	54	2	57	29	0.22
65	69	2	63.5	38.5	0.37
80	84	2	85.5	45	0.63
100	104	2	105	55	0.95
125	129	2	124	69	1.42
150	154	2	143	84	2.03
200	204	2	178	110	3.80
250	254	2	216	140	5.80
300	306	3	300	168	10.60
350	356	3	350	195	14.40
400	406	3	400	223	22.54

### Pulled reducing tees

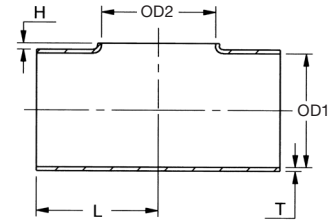

DN1 x DN2	OD1 x OD2	T Wall	L	H	Weight
mm	mm	mm	mm*	mm*	kg
50 x 25	54 x 28	2	57	29	0.20
50 x 40	54 x 44	2	57	29	0.20
65 x 40	69 x 44	2	63.5	38	0.35
65 x 50	69 x 54	2	63.5	38	0.35
80 x 40	84 x 44	2	85.5	45	0.60
80 x 50	84 x 54	2	85.5	45	0.60
80 x 65	84 x 69	2	85.5	45	0.60
100 x 50	104 x 54	2	105	55	0.90
100 x 65	104 x 69	2	105	55	0.90
100 x 80	104 x 84	2	105	55	0.90
125 x 80	129 x 84	2	124	69	1.30
125 x 100	129 x 84	2	124	69	1.30
150 x 80	154 x 84	2	143	84	1.90
150 x 100	154 x 104	2	143	84	1.90
150 x 125	154 x 129	2	143	84	1.90
200 x 100	204 x 104	2	178	110	3.60
200 x 125	204 x 129	2	178	110	3.60
200 x 150	204 x 154	2	178	110	3.60
250 x 150	254 x 154	2	216	140	5.50
250 x 200	254 x 204	2	216	140	5.50
300 x 200	306 x 206	3	300	165	10.30

Notes

\* Approximate

# Metric Tube & Fittings

## Range/Sizes - Metric Tees and End Caps

### Equal tees with branch

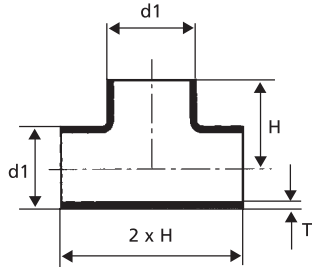

DN	d1 OD	T Wall	H	Weight
mm	mm	mm	mm	kg
25	28	1.5	28.5	0.07
32	38	1.5	47.5	0.18
32	38	2	47.5	0.24
40	44.5	2	47.5	0.24
50	54	2	57.0	0.34
65	69	2	63.5	0.48
80	84	2	85.5	0.77
100	104	2	105	1.19
125	129	2	124	1.76
150	154	2	143	2.03
200	204	2	178	3.84

### Pressed end caps

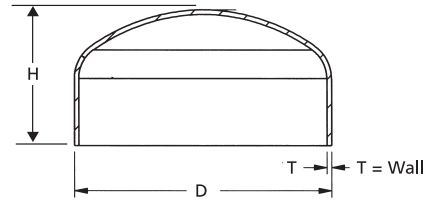

DN	D OD	T Wall	H Height	Weight
mm	mm	mm	mm	kg
25	28	1.5	12	0.02
30	33	2	12	0.03
32	38	2	15	0.03
40	44.5	2	16	0.04
50	54	2	19	0.06
80	84	2	23	0.13
100	104	2	24	0.19
125	129	2	34	0.31
150	154	2	41	0.44
200	206	3	50	1.13
250	256	3	55	1.62
300	306	3	70	2.47
350	356	3	89	3.52
400	406	3	98	4.52
450	458	4	108	5.5
500	508	4	120	6.6
600	608	4	140	9.2

# Metric Tube & Fittings

## Range/Sizes - Metric Reducers

### Concentric and eccentric reducers

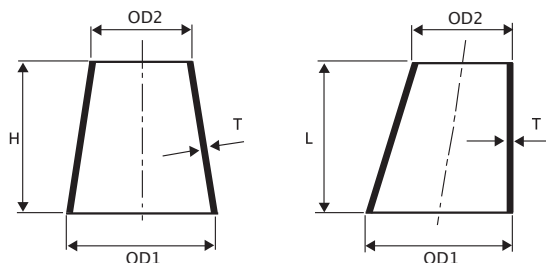

DN1 x DN2	OD1 x OD2	T Wall	Length	Weight
mm	mm	mm	mm	kg
25 x 20	28 x 23	1.5	15	0.01
30 x 25	33 x 28	1.5	15	0.02
40 x 25	43 x 28	1.5	45	0.06
40 x 25	44 x 29	2	45	0.08
50 x 25	54 x 29	2	75	0.16
50 x 40	54 x 44	2	30	0.07
65 x 40	69 x 44	2	75	0.21
65 x 50	69 x 54	2	45	0.14
80 x 40	84 x 44	2	120	0.39
80 x 50	84 x 54	2	90	0.31
80 x 65	84 x 69	2	45	0.17
100 x 50	104 x 54	2	150	0.60
100 x 65	104 x 69	2	105	0.46
100 x 80	104 x 84	2	60	0.28
125 x 50	129 x 54	2	225	1.03
125 x 80	129 x 84	2	135	0.72
125 x 100	129 x 104	2	75	0.44
150 x 80	154 x 84	2	210	1.26
150 x 100	154 x 104	2	150	0.97
150 x 100	156 x 106	3	150	1.48
150 x 125	154 x 129	2	75	0.53
200 x 100	204 x 104	2	300	2.32
200 x 125	204 x 129	2	225	1.88
200 x 150	204 x 154	2	150	1.35
250 x 125	254 x 129	2	375	3.61

DN1 x DN2	OD1 x OD2	T Wall	Length	Weight
mm	mm	mm	mm	kg
250 x 150	254 x 154	2	300	3.08
250 x 200	254 x 204	2	150	1.73
250 x 200	255 x 205	2.5	150	2.20
250 x 200	256 x 206	3	150	2.61
300 x 200	304 x 204	2	300	3.83
300 x 200	306 x 206	3	300	5.8
300 x 250	304 x 254	2	150	2.10
300 x 250	306 x 256	3	150	3.18
350 x 200	356 x 206	3	450	9.5
350 x 250	356 x 256	3	300	6.9
350 x 300	356 x 306	3	150	3.74
400 x 200	406 x 206	3	600	13.8
400 x 250	406 x 256	3	450	11.2
400 x 300	406 x 306	3	300	8.0
400 x 350	406 x 356	3	150	4.30
450 x 300	456 x 306	3	450	12.9
450 x 350	456 x 356	3	300	9.2
450 x 400	456 x 406	3	150	4.87
500 x 300	506 x 306	3	600	18.4
500 x 350	506 x 356	3	450	14.6
500 x 400	506 x 406	3	300	10.3
500 x 450	506 x 456	3	150	5.4
600 x 400	606 x 406	3	600	22.8
600 x 450	606 x 456	3	450	18.0
600 x 500	606 x 506	3	300	12.6

# Metric Tube & Fittings

## Range/Sizes - Metric Pressed Collars, Flanges, Clamps and Clips

### Pressed collars

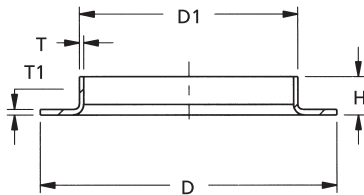

DN	D1 x T x H	T1	D	Weight
mm	mm	mm	mm	kg
15	20 x 1.5 x 7	1.5	51	0.04
20	25 x 1.5 x 7	1.5	58	0.04
25	30 x 1.5 x 8	1.5	68	0.05
32	38 x 2 x 10	2	78	0.06
40	44.5 x 2 x 10	2	88	0.09
50	54 x 2 x 12	2	102	0.11
65	69 x 2 x 12	2	122	0.15
80	84 x 2 x 13	2	138	0.19
100	104 x 2 x 16	2	158	0.24
	106 x 3 x 16	3	158	0.36
125	129 x 2 x 15	2	188	0.31
	131 x 3 x 20	3	188	0.47
150	154 x 2 x 19	2	212	0.38
	156 x 3 x 20	3	212	0.57
200	204 x 2 x 21	2	268	0.54
	206 x 3 x 25	3	268	0.82
250	256 x 3 x 25	3	320	1.07
300	306 x 3 x 21	3	370	1.21

### Flanges

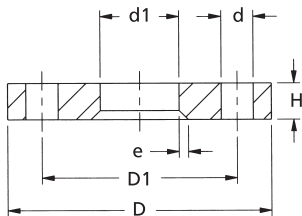

Mild steel Zinc Plated and Passivated with drilling dimensions to BS4504 PN10 Reduced Thickness (Unipipe)

Other types of backing flanges are also available including Epoxy Coated Aluminium and Pressed Stainless Steel types.

DN	D	D1	No of Bolt Holes	d	d1	H	Flange Weight
mm	mm	mm	mm	mm	mm	mm	kgs/pc
25	115	85	4	14	35	10	0.6
32	140	100	4	18	42	10	1.0
40	150	110	4	18	50	10	1.2
50	165	125	4	18	60	10	1.4
65	185	145	4	18	75	10	1.7
80	200	160	8	18	90	10	1.8
100	220	180	8	18	110	10	1.9
125	250	210	8	18	136	12	3.1
150	285	240	8	22	161	12	3.8
200	340	295	12	22	213	12	4.9
250	395	350	12	22	262	16	8.0
300	445	400	12	22	313	19	11.0
350	505	460	16	22	364	22	15.5
400	565	515	16	26	418	22	18.1
450	615	565	20	26	470	25	22.1
500	670	620	20	26	520	28	25.4
600	780	725	20	29	630	31	30.0

### Clamps and clips

A range of tube Clamps and Clips is available in Grade 1.4404 (316L) Stainless Steel as well as Zinc Plated Mild Steel.

# General Information

## General Data

### Calculation of tube weights

Form	Dimensions	Weight for Alloys of Density
	mm	p Kg/dm <sup>3</sup>
Pipe/Tube (Round)	Outside diameter = D Inside diameter = d Wall thickness = t	0.0031416 (D-t)tp, or 0.0031416 (d+t)tp      Kg/m
Square/Rectangular Tube	Sides = a <sub>1</sub> , a <sub>2</sub> , Wall thickness = t	0.001 (2a <sub>1</sub> + 2a <sub>2</sub> -4t)tp      Kg/m

### Elements and symbols

Aluminium – <b>Al</b>	Cobalt – <b>Co</b>	Lithium – <b>Li</b>	Oxygen – <b>O</b>	Tin – <b>Sn</b>
Arsenic – <b>As</b>	Columbium – <b>Cb</b> *	Manganese – <b>Mn</b>	Phosphorus – <b>P</b>	Titanium – <b>Ti</b>
Boron – <b>B</b>	Copper – <b>Cu</b>	Molybdenum – <b>Mo</b>	Selenium – <b>Se</b>	Zinc – <b>Zn</b>
Cadmium – <b>Cd</b>	Hydrogen – <b>H</b>	Nickel – <b>Ni</b>	Silicon – <b>Si</b>	Zirconium – <b>Zr</b>
Carbon – <b>C</b>	Iron – <b>Fe</b>	Niobium – <b>Nb</b>	Sulphur – <b>S</b>	
Chromium – <b>Cr</b>	Lead – <b>Pb</b>	Nitrogen – <b>N</b>	Tellurium – <b>Te</b>	* The American designation for Niobium

### Densities

Material	Density Kg/dm <sup>3</sup>
Aluminium	2.70
Stainless Steel	
– Ferritic/Martensitic	7.75
– Austenitic	7.75
Copper	8.90
Brass	8.47
Bronze	8.89
INCOLOY Alloy 800	7.95
INCOLOY Alloy 800H	7.95
INCOLOY Alloy 825	8.14
INCOLOY Alloy 903	8.14
INCOLOY Alloy DS	7.92
INCONEL Alloy 600	8.42
INCONEL Alloy 601	8.06

### Densities

Material	Density Kg/dm <sup>3</sup>
INCONEL Alloy 617	8.36
INCONEL Alloy 625	8.44
INCONEL Alloy 690	8.19
INCONEL Alloy 718	8.19
INCONEL Alloy X-750	8.25
MONEL Alloy 400	8.83
MONEL Alloy K-500	8.46
Nickel 200	8.89
Nickel 201	8.89
UNS 31803	7.80
17-4 PH	7.75

### Comparitive densities

Material	Density Kg/dm <sup>3</sup>
Stainless Steel	1.000
Stainless Steel	
– Ferritic/Martensitic	0.977
Mild and Carbon Steel	0.994
Low Alloy Steel	0.987
Aluminium	0.341
Copper	1.134
Brass	1.066
Aluminium Bronze	0.970
Titanium	0.571
Lead	1.440

### Abbreviations for Standards Organisations

Abbreviations for standards organisations and documents, referred to in this manual, are expanded below:

<b>AFNOR</b>	French Standards Association	<b>EN</b>	European Norm (Standard) issued by European Committee for Standardisation (CEN)
<b>AISI</b>	American Iron and Steel Institute	<b>ISO</b>	International Organisation for Standardisation
<b>ANSI</b>	American National Standards Institute, Inc.	<b>JIS</b>	Japanese Industrial Standards issued by Japanese Standards Authority (JSA)
<b>API</b>	American Petroleum Institute	<b>MSS</b>	Manufacturers Standardisation Society of the Valve and Fittings Industry, Inc.
<b>ASME</b>	The American Society of Mechanical Engineers	<b>SIS</b>	Swedish Standards
<b>ASTM</b>	American Society for Testing and Materials	<b>SMS</b>	Swedish Mechanical Standards
<b>BS</b>	British Standards issued by British Standards Institution (BSI)	<b>UNI</b>	Italian Standards
<b>DIN</b>	German Standards		



# General Information

## Standard and Birmingham Wire Gauges

### Conversion of SWG and BWG number to wall thickness

Standard Wire Gauge (formerly Imperial Wire Gauge) SWG		
SWG	Wall Thickness	
	in	mm
0 SWG	0.324	8.23
1 SWG	0.300	7.62
2 SWG	0.276	7.01
3 SWG	0.252	6.40
4 SWG	0.232	5.89
5 SWG	0.212	5.38
6 SWG	0.192	4.88
7 SWG	0.176	4.47
8 SWG	0.160	4.06
9 SWG	0.144	3.66
10 SWG	0.128	3.25
11 SWG	0.116	2.95
12 SWG	0.104	2.64
13 SWG	0.092	2.34
14 SWG	0.080	2.03
15 SWG	0.072	1.83
16 SWG	0.064	1.63
17 SWG	0.056	1.42
18 SWG	0.048	1.22
19 SWG	0.040	1.02
20 SWG	0.036	0.91
21 SWG	0.032	0.81
22 SWG	0.028	0.71
23 SWG	0.024	0.61
24 SWG	0.0220	0.56
25 SWG	0.0200	0.51
26 SWG	0.0180	0.46
27 SWG	0.0164	0.42
28 SWG	0.0148	0.38
29 SWG	0.0136	0.35
30 SWG	0.0124	0.31
31 SWG	0.0116	0.29
32 SWG	0.0108	0.27
33 SWG	0.0100	0.25
34 SWG	0.0092	0.23
35 SWG	0.0084	0.21
36 SWG	0.0076	0.19
37 SWG	0.0068	0.17
38 SWG	0.0060	0.15
39 SWG	0.0052	0.13
40 SWG	0.0048	0.12

Birmingham Wire Gauge BWG		
BWG	Wall Thickness	
	in	mm
0 BWG	0.340	8.64
1 BWG	0.300	7.62
2 BWG	0.284	7.21
3 BWG	0.259	6.58
4 BWG	0.238	6.05
5 BWG	0.220	5.59
6 BWG	0.203	5.16
7 BWG	0.180	4.57
8 BWG	0.165	4.19
9 BWG	0.148	3.76
10 BWG	0.134	3.40
11 BWG	0.120	3.05
12 BWG	0.109	2.77
13 BWG	0.095	2.41
14 BWG	0.083	2.11
15 BWG	0.072	1.83
16 BWG	0.065	1.65
17 BWG	0.058	1.47
18 BWG	0.049	1.24
19 BWG	0.042	1.07
20 BWG	0.035	0.89
21 BWG	0.032	0.81
22 BWG	0.028	0.71
23 BWG	0.025	0.64
24 BWG	0.022	0.56
25 BWG	0.020	0.51
26 BWG	0.018	0.46
27 BWG	0.016	0.41
28 BWG	0.014	0.36
29 BWG	0.013	0.33
30 BWG	0.012	0.30
31 BWG	0.010	0.25
32 BWG	0.009	0.23
33 BWG	0.008	0.20
34 BWG	0.007	0.18
35 BWG	0.005	0.13
36 BWG	0.004	0.10

Notes:

Notes:



[www.aalco.co.uk](http://www.aalco.co.uk)

**ABERDEEN**

Tel 01224 854810  
Fax 01224 871982  
e-mail [aberdeen@aalco.co.uk](mailto:aberdeen@aalco.co.uk)

**AYLESBURY**

Tel 01296 461700  
Fax 01296 339923  
e-mail [aylesbury@aalco.co.uk](mailto:aylesbury@aalco.co.uk)

**BELFAST**

Tel 02890 838 838  
Fax 02890 837 837  
e-mail [belfast@aalco.co.uk](mailto:belfast@aalco.co.uk)

**BIRMINGHAM**

Tel 0121 585 3600  
Fax 0121 585 6864  
e-mail [birmingham@aalco.co.uk](mailto:birmingham@aalco.co.uk)

**CHEPSTOW**

Tel 01291 638 638  
Fax 01291 638 600  
e-mail [chepstow@aalco.co.uk](mailto:chepstow@aalco.co.uk)

**DYFED**

Tel 01269 842044  
Fax 01269 845276  
e-mail [dyfed@aalco.co.uk](mailto:dyfed@aalco.co.uk)

**ESSEX**

Tel 01268 884200  
Fax 01268 884220  
e-mail [essex@aalco.co.uk](mailto:essex@aalco.co.uk)

**GLASGOW**

Tel 0141 646 3200  
Fax 0141 646 3260  
e-mail [glasgow@aalco.co.uk](mailto:glasgow@aalco.co.uk)

**HULL**

Tel 01482 626262  
Fax 01482 626263  
e-mail [hull@aalco.co.uk](mailto:hull@aalco.co.uk)

**LEEDS**

Tel 0113 276 3300  
Fax 0113 276 0382  
e-mail [leeds@aalco.co.uk](mailto:leeds@aalco.co.uk)

**LIVERPOOL**

Tel 0151 207 3551  
Fax 0151 207 2657  
e-mail [liverpool@aalco.co.uk](mailto:liverpool@aalco.co.uk)

**MANCHESTER**

Tel 01204 863456  
Fax 01204 863430  
e-mail [manchester@aalco.co.uk](mailto:manchester@aalco.co.uk)

**NEWCASTLE**

Tel 0191 491 1133  
Fax 0191 491 1177  
e-mail [newcastle@aalco.co.uk](mailto:newcastle@aalco.co.uk)

**NORWICH**

Tel 01603 787878  
Fax 01603 789999  
e-mail [norwich@aalco.co.uk](mailto:norwich@aalco.co.uk)

**NOTTINGHAM**

Tel 0115 988 2600  
Fax 0115 988 2636  
e-mail [nottingham@aalco.co.uk](mailto:nottingham@aalco.co.uk)

**SOUTHAMPTON**

Tel 023 8087 5200  
Fax 023 8087 5275  
e-mail [southampton@aalco.co.uk](mailto:southampton@aalco.co.uk)

**STOKE**

Tel 01782 375700  
Fax 01782 375701  
e-mail [stoke@aalco.co.uk](mailto:stoke@aalco.co.uk)

**SWANLEY**

Tel 01322 610900  
Fax 01322 610910  
e-mail [swanley@aalco.co.uk](mailto:swanley@aalco.co.uk)



Also available in Ireland

**DUBLIN**

Tel +353 1 6298 600  
Fax +353 1 6299 200  
e-mail: [dublin@amari-dublin.com](mailto:dublin@amari-dublin.com)

**CORK**

Tel +353 21 4310 520  
Fax +353 21 4310 519  
e-mail: [cork@amari-cork.com](mailto:cork@amari-cork.com)