

aalco[®]

Company Profile

Stainless Steel

Aluminium

Copper, Brass & Bronze

General Data



www.aalco.co.uk

To receive a copy of any of the following literature or to download a pdf version please visit www.aalco.co.uk or contact your local Service Centre. Details on back cover.

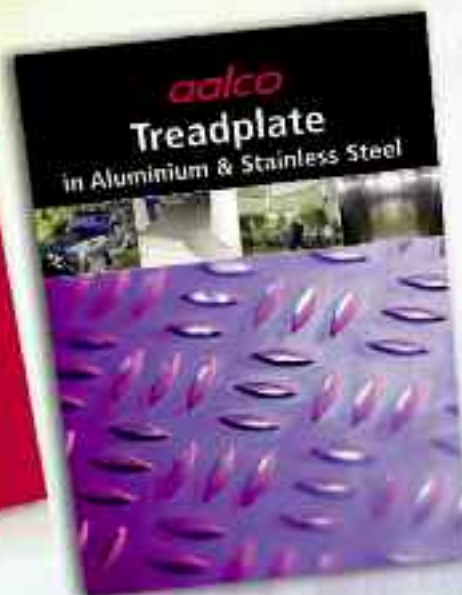
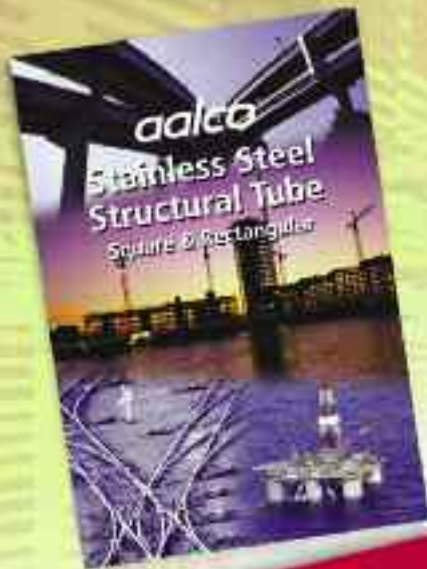

The information contained herein is based on our present knowledge and experience and is given in good faith. However, no liability will be accepted by the Company in respect of any action taken by any third party in reliance thereon.

As the products detailed herein may be used for a wide variety of purposes and as the Company has no control over their use, the Company specifically excludes all conditions or warranties expressed or implied by statute or otherwise as to dimensions, properties and/or their fitness for any particular purpose. Any advice given by the Company to any third party is given for that party's assistance only and without any liability on the part of the Company.

Any contract between the Company and a customer will be subject to the Company's Conditions of Sale. The extent of the Company's liabilities to any customer is clearly set out in those Conditions; a copy of which is available on request.

Weights

All weights shown in this publication are for guidance only. They are calculated using nominal dimensions and scientifically recognised densities. Please note that in practice, the actual weight can vary significantly from the theoretical weight due to variations in manufacturing tolerances and compositions.

Copyright 2007: All Rights reserved: Aalco Metals Limited. No part of this publication may be reproduced, stored in a retrieval system or transmitted in any form or by any means, electronic, mechanical, recording or otherwise without the prior written consent of the proprietor.

Aalco is a registered trade mark of Aalco Metals Limited.

Contents

Introduction

The Company	Page 2
Product Range	Page 3-4

Stainless Steel

Product Range	Page 5
Introduction	Page 6-9
Specifications	Page 10-12
Corrosion Resistance	Page 13-15
Finishes	Page 16-20
Care & Maintenance	Page 21-24
Fabrication	Page 25-27
Rolled Product Range	Page 28
Hot Rolled Product Specifications	Page 29-30
Cold Rolled Product Specifications	Page 31-32
Bar Product Range & Specifications	Page 33-35
Tubular Products Range & Specifications	Page 36-47

Aluminium

Product Range	Page 48
Introduction	Page 49-50
Specifications	Page 51-53
Installation & Maintenance	Page 54
Fabrication	Page 55-58
Rolled Products Range & Specifications	Page 59-61
Extruded Products Range & Specifications	Page 62-69

Copper

Product Range	Page 70
Introduction	Page 71-72
Specifications	Page 73-81
Fabrication	Page 82-84

General Data

General Data	Page 85-89
--------------	------------

Aalco is the UK's largest independent multi-metals stockholder. Customers from every sector of UK manufacturing and engineering industry, whether small local businesses or large multinational corporations, benefit from a cost-effective single source for all their metals requirements:

- An inventory that includes aluminium, stainless steel, copper, brass, bronze and nickel alloys in all semi-finished forms
- Comprehensive processing services providing items cut and/or finished to customer requirements
- Eighteen locations bringing local service to every corner of the UK
- Ongoing investment in technology and logistics to ensure on-time delivery

No order is too large or too small and Aalco offers a responsive and competitive service for supplying anything from single item orders to major JIT contracts, tailoring this service to the individual needs.

Whatever your requirement, in whatever quantity, your local Aalco service centre is ready and willing to satisfy your needs. For a quotation, for further information, more extensive technical information, advice on product selection or to place an order, please contact your local Aalco service centre or refer to the web site

www.aalco.co.uk

Service



The most comprehensive stock range; the highest investment in processing equipment; local service centres nationwide; helpful, friendly, knowledgeable staff and the industry's biggest fleet of delivery vehicles – it all adds up to unbeatable service.

Aalco has maintained market leadership over many years through an absolute dedication to customer service – a service level that is continuously monitored and improved through key performance indicators.

That's why, for reliable, on-time delivery of exactly what you want, when and where you need it, whether it's a small one-off item or a complex JIT contract, Aalco is the essential first choice.



People

Exceptional customer service starts with people. Aalco develops and retains high quality personnel using a variety of 'in house' courses which cover both skills training, product knowledge and teamwork.

Every Aalco Service Centre has a dedicated team of people working together to provide an unbeatable service to customers in their region.

Customers can expect to receive a quick and informed response to any enquiries for material or for information.

Quality



Aalco takes great care when selecting manufacturing sources for its products and every mill we use is measured against a series of predetermined quality control requirements.

All products supplied by Aalco conform to the relevant BS or international standards certification can be supplied on request.

Aalco service centres operate a quality manual designed to ISO9000/2005 requirements. Many vendor approvals and bespoke quality control systems are operated through individual Aalco service centres, including aerospace approved materials from Southampton and Hull.

AALCO: Delivering Customer Service, Investing in Capability

Standard Stock & "Specials"

In providing customers with a cost-effective single source for all their metals requirements, over 50% of Aalco sales are made up of non standard or customer-special items. Many such items are held in stock at the Service Centres for call-off by their local customers, whilst others are processed as required.

The Aalco multi-metal stock range comprises around 10,000 items of stainless steel, aluminium, copper, brass and bronze in all semi-finished forms. Full detail of the ranges is given on page 28 for stainless steel rolled products, page 33 for stainless steel bar, page 36 for stainless steel tubular products (tube, pipe, fittings & flanges), page 59 for rolled aluminium, page 62 for Aluminium Extrusions and page 70 for Copper-Based Alloys.

This combines with a comprehensive processing services offering items cut to customer's instructions as well as finishing and coating. In addition, Aalco regularly arranges sub-contract processing using a range of approved suppliers.

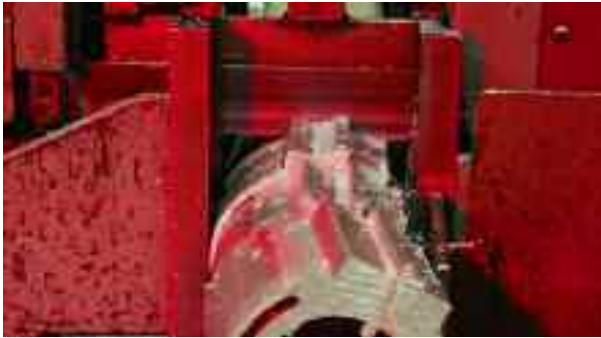

Aluminium Extrusions

As well as holding the UK's widest range of standard sections, Aalco has developed a particular expertise in the sourcing, stocking and processing of bespoke extrusions, bringing customers the benefit of Aalco's unrivalled purchasing power and sourcing expertise.

The standard stock range (detailed fully on page 60) covers round, flat & square bars in a choice of machinable alloys; tube, scaffold tube & box section; angle, tee & channel; a complete package of Road Transport sections plus a selection of shapes and sizes in various aerospace alloys.

The range of Road Transport sections includes bearers, runners, side rails, side guards, corner pillars, cant rails, tops hats, drop-sides, Zeds, mouldings, cappings and kick strips as well as a range of flooring options.

Processing Services

Processed material can save customers both time and money. Understanding this, Aalco has made a major investment in a wide range of modern processing equipment, particularly for cutting and finishing, at both its local and central service centres.

In addition, Aalco regularly arranges a wide array of processing services for customers on a sub-contract basis.



Logistics & Systems

Like all world-class distribution businesses, Aalco operates a hub and satellite system.

The satellites are 19 local Service Centres providing unrivalled service to customers in their local area.

The hub is The Metal Centre – a 270,000 square foot (25,000m²) facility located in the West Midlands, bringing together 6,000 tonnes of stock and 130 employees. This state-of-the-art facility has a capacity to handle over 150,000 tonnes per year thanks to the largest automated handling system in Europe – this comprises a 5,500 cassette Kasto system in two 14 metre high units and one 8 metre high unit.

Linking The Metal Centre to the Service Centres is a 25-vehicle carrier fleet that travels overnight to ensure that an item in stock anywhere across the country can be delivered to any Aalco customer the next day, using the local truck fleet of well over 100 vehicles.

Keeping the whole system operating at maximum efficiency are highly sophisticated Information Systems, designed in-house and undergoing constant development to support the evolution of the Aalco business and maximise customer service.

Product Information

Aalco provides a wealth of product information to ensure that its customers are fully informed, not just about the choice of materials and sizes available but also on a range of technical topics including product selection, specifications, properties, fabrication & joining, finishing, installation and maintenance.

Shown inside the front cover of this brochure is a selection of the other publications that are all available free of charge from your local Service Centre - Everything from simple data-sheets to a CD-ROM with over 400 pages of technical information on stainless steel tubular products. What's more, all of these publications are available on-line and for download at any time of the day or night, every day of the year at www.aalco.co.uk

Road Transport Products

The range includes:

- **Rolled Products** – sheet & patterned sheet, plate & treadplate, shate
- **Standard Extrusions** – angle, channel, tee, tube & box section, flat/square/round bar
- **Special Sections** – Bearers/Runners, Floor Planks, Side Raves & Guards, Corner Pillars, Cant Rails, Top Hats, Zeds, Mouldings, Kick Strips
- **Dropside Sections & Systems**
- **Slip-resistant flooring** – Phenolic mesh-faced Birch wood plywood
- **Cappings** – ABS & Aluminium/ABS
- **Patterned aluminium flooring sheet**
- **GRP Panels**



Energy, Offshore & Process Industries

Aalco has established a Contract Services Division to meet the specialist project requirements of the energy, offshore and process industries.



Based at Aalco's Service Centre in Hull, the Contract Services team includes a number of staff with extensive experience in the sector. With the backing of Aalco's huge UK stock as well as access to the Amari stock held by Aalco's associated companies in Europe, the new Division provides the process industries with an outstanding service for all project requirements. Customers range from nuclear fuel reprocessing facilities to onshore/offshore oil, gas and petrochemical plants where Aalco has ongoing exclusive supply contracts.

Export

The wide Aalco stock range is of great interest to customers throughout the world seeking ready availability of semi-finished metal alloys.

Because export customers have specialist requirements in areas such as packaging and documentation, all exports from Aalco are handled by a dedicated team located at our Southampton service centre, which sources a full range of materials and:

- Provides the specialist knowledge and procedures required to service export markets together with the appropriate quality approvals
- Arranges special testing, inspection, documentation and releases as required
- Is ideally located to provide international deliveries to customers world-wide.

Southampton is one of the UK's premier ports, with efficient and economic shipping routes for destinations across Europe and throughout the world. Equally, air-freight can be readily arranged for more urgent cargos.









Aalco stock all of the commonly required forms of stainless steel including sheet, coil, strip, plate, bar and sections as well as a full range of tube, pipe fittings and flanges.

In addition to a comprehensive range of standard products, Aalco Service Centres stock industry specific items and customer specials with numerous specialist products and alloys satisfying the needs of a broad range of industries.

Aalco also provides a complete range of processing services that include bar, tube & pipe cutting; plate processing; coil processing and surface finishing.

The Core Product Ranges are:

<p>Rolled Products</p> <ul style="list-style-type: none"> Quarto Plate CPP Plate Sheet Polished Sheet Type 1.4003 plate and sheet Treadplate Weld Mesh 		
<p>Bar and Sections</p> <ul style="list-style-type: none"> Round and Hexagon Bar Rolled Edge Flat Bar Angle Square 		
<p>Tube</p> <ul style="list-style-type: none"> Seamless imperial sizes Welded Metric Nominal Diameter (ND) sizes Decorative – Round, Square, Rectangular Structural – Square and Rectangular up to 250mm Hygienics 		
<p>Pipe</p> <ul style="list-style-type: none"> Seamless and welded from 1/4" to 12" 		
<p>Fittings</p> <ul style="list-style-type: none"> Seamless and Welded Butt Weld Fittings BSP Screwed Hygienic Fittings Welded Metric Nominal Diameter (ND) 		
<p>Flanges</p> <ul style="list-style-type: none"> ASTM A182 / ANSI B16.5 BS 10 Flanges 316L Table E BS 4504 / EN 1092 Raised Face, 16 Bar Aluminium and Coated Mild Steel Backing Flanges 		

Full detail of all product ranges, alloys and sizes can be found in the Aalco Stocklist available **FREE** from your local Service Centre as well as on the website. The Aalco Tubular Products Data-Book provides a comprehensive 400-page guide to this extensive product range including all relevant specifications – this is available online or from your local Service Centre on CD-ROM.



Stainless steel is not a single material but the name for an extensive range of corrosion resistant alloy steels. These alloys were first developed early last century and by the 1920's several types had been established. In the UK Harry Brearley developed a 13% chromium steel, whilst working on a steel to improve the wear characteristics of rifle barrels. He observed that this steel only reacted slowly with his laboratory etching acids and when discarded sample pieces which were left outside in the rain did not rust, like lower chromium steel did. This "chromium/carbon" steel was eventually used for cutlery as it could be hardened by heat treatment in a similar way to the non-chromium cutlery steels that were then being used. This reinforced the position of Harry Brearley's native Sheffield as a world centre for cutlery and blade production in the 20th century.

Around the same time metallurgists in France, Germany and the USA were also developing corrosion resistant steels. All these steels had the same basic ingredient, chromium at a minimum level of about 11%. These steels included what would later be classified as "ferritic", plain chromium steels with lower carbon levels than Harry Brearley's "martensitic" steel and "austenitic" steels with additional manganese or nickel.

So who invented stainless steel?

You have a choice; it depends where you come from or perhaps who you buy your steel from!

The current European standards for stainless steels contain in excess of 80 different steel grades, providing a wide range of properties to meet the demands of a very diverse range of applications to which these corrosion resistant steels can be put.

Worldwide demand for stainless steel is currently increasing at a rate of about 5% per annum. Annual consumption is now well over 20 million tonnes and continues to rise, particularly in application areas such as the building and construction industries and for household and kitchen appliance applications.

New uses continue to be found for stainless steels.

Their excellent corrosion resistance, attractive appearance, wide ranging mechanical properties and low maintenance costs offer competitive solutions when choosing modern materials for new applications. Stainless steels often provide better whole-life cycle cost benefits than alternative, lower initial cost material choices, such as painted or galvanized carbon steel.

Stainless steels are 100% recyclable and have been traditionally recycled for making new steel. About 80% of the newly made stainless steel produced in by western European steelmakers comes from recycled scrap, which requires very little processing before being remelted into new steel.

What is Stainless Steel?

Stainless steels are a group of corrosion resistant steels that contain a minimum of 10.5 % chromium. There are other steels, including some tool steels that also contain these levels of chromium. The difference between these steels and stainless steels is that in stainless steels the chromium is added principally to develop corrosion resistance. The European standard for stainless steels, EN 10088 (published in the UK as BS EN 10088) defines stainless steels as steels with a minimum of 10.5% for use in applications where their corrosion resistance is required.

Many commercially available stainless steels contain more than this minimum level of chromium and, in addition, contain varying amounts other alloying additions including nickel, molybdenum, titanium, niobium etc. These additions are made, not only to

enhance the corrosion resistance of the steel but also develop other properties, such as mechanical strength, hardness, toughness, magnetic properties etc. or to change working characteristics including formability, machinability and weldability. Stainless steels can also be used in heat resisting and cryogenic applications as they also have excellent oxidation resistance. These particular steels generally have enhanced chromium levels to improve their heat resisting properties. They are covered by the BS EN 10095 standard.

The behaviour of the various stainless steels during manufacture, fabrication and in-service not only depends on their chemical compositions, but also on the design and surface finish of the manufactured items. Careful selection of the most appropriate steel grade, design and surface finish are vital to the successful application of stainless steels.



Types of Stainless Steel (Families)

Stainless steels have “family” names that reflect their metallurgical (atomic) structure.

These groupings, commonly referred to as families, are:

- Ferritic
- Austenitic
- Duplex (austenitic-ferritic)
- Martensitic and precipitation hardening.

More highly alloyed austenitic and duplex grades with better pitting corrosion resistance than the standard grades are known as “super-austenitic” and “super-duplex” stainless steels.

The properties of grades in these families can be quite different. This enables stainless steels as a group of materials to be used for such a wide range of applications.

The main features of each family are:

Ferritic

- Magnetic
- Low carbon
- Chromium main alloying element, typically 10.5-17%
- Not hardenable by heat treatment
- Typical grades 409 (1.4512), 430 (1.4016)

Austenitic

- Non-magnetic (when fully softened)
- Low carbon
- Chromium contents typically 16-20%
- Nickel contents typically 7-13%
- Not hardenable by heat treatment, but strengthen significantly during cold working
- Typical grades 304 (1.4301), 316 (1.4401)

Duplex

- Magnetic
- Low carbon
- Chromium contents typically 21-26%
- Nickel contents typically 3.5-6.5%
- Nitrogen added, typically 0.05-0.40%
- Not hardenable by heat treatment, but higher annealed strength levels than ferritic or austenitic stainless steels
- Typical grade 2205 (1.4462)

Martensitic and precipitation hardening

- Magnetic or non-magnetic
- Carbon can be up to 0.95%
- Chromium contents typically 12.0-17%
- Nickel contents typically 2-7%
- Precipitation hardening types also contain aluminium or copper
- Hardenable by heat treatment
- Typical grades 420 (1.4021), 17/4PH (1.4542)

Corrosion Resistance

All stainless steels are able to resist some level of corrosion. There is a wide range of service media and different forms that corrosion attack can take. This is one reason why there are the four main families of stainless steels and why each has its own range of grades. Stainless steels all rely on the chromium content to form a corrosion resisting, tightly adherent, chromium-rich passive layer. This invisible, very thin (about 5×10^{-9} m i.e. 0.00000005 metre thick) inert layer is the key to the durability of stainless steels.

If mechanically damaged or chemically attacked, the passive layer repairs itself, maintaining the protection of the underlying metal. This repair process is normally rapid but does require oxygen, which is present in most working environments. In this condition the surface is said to be “passive”. If the passive layer is broken down or not allowed to reform if damaged, the surface is “active” and corrosion can take place.

The addition of more chromium and other alloying elements such as nickel and molybdenum improve the resilience of the passive film and so make the resulting steel more resistant to a wider range of corrosive conditions than the basic 10.5% chromium composition.

Other Properties of Stainless Steels

In addition to corrosion resistance, specific stainless steel grades have other properties that can be useful either in service or during manufacture and fabrication. These properties can differ widely between the families and various grades and include:

● Mechanical Strength

The mechanical strength of the ferritic (around 500 MPa) and austenitic (around 600 MPa) stainless steels is similar to low alloy steels. The austenitic steels maintain their strength better than the ferritic stainless steels or non-stainless structural steels with increases in temperature. This makes the austenitic stainless steels good choices for fire and heat resisting applications.

Duplex steels are about twice the strength of these others steels, with yield strengths of around 450 MPa and tensile strengths of 700 MPa. Their mixed structures of ferrite and austenite together with their nitrogen contents develop these higher strength levels. The strength of the martensitic and precipitation hardening steels can be altered over a wide range by heat treatment. The precipitation hardening types, in particular are capable of very high strength levels, up to 1100 MPa.

● Hardness

Hardness, the resistance to indentation or scratching, is similar for all the “softened” steels i.e. the ferritic, austenitic and duplex family grades. Only the martensitic grades with their enhanced carbon levels are capable of being hardened. Grades such as 440C (1.4125) can be hardened to

around 60 HRC (Rockwell C). In contrast the precipitation hardening grades, despite their name, are mainly used for their heat treatable strength rather than hardness.

● **Toughness and ductility**

The properties of toughness and ductility usually go together, although they are different properties. Toughness is a measure of how much energy is absorbed by the metal during fracture. A brittle material has low toughness. Usually as temperatures get lower, the toughness of metals decreases. The austenitic stainless steels have excellent toughness, not only at ambient temperatures, but also at cryogenic temperatures (down to -196°C). The ferritic, duplex and precipitation hardening steels have good ambient temperature toughness and moderate toughness, down to about -40°C . Martensitic steels are however usually brittle, especially at most temperatures below ambient.

● **Work Hardening**

Work hardening is the progressive increase in strength and hardness as a material is “cold” worked. Most metals work-harden to some degree during operations like cold forming, bending or machining. The work hardening rate of the austenitic stainless steels is higher than most other metals. This is due to structural changes in the steel, as some of the austenite transforms to the stronger martensite constituent. Work hardening can be both a disadvantage and an advantage. It is undesirable during machining, but advantageous during some cold drawing operations, where it can delay premature failure during working. Inter-stage annealing operations are usually needed however when manufacturing severely drawn or complex shaped parts. The effects of cold working are reversible by annealing heat treatments at around 1050°C .

● **Magnetic Permeability**

Magnetic permeability is a measure of attraction to a permanent magnet. Most materials, including many metals are not attracted to a magnet. The common exception is iron and most steels, which can also be turned into magnets i.e. be magnetised and demagnetised by electrical fields. Softened austenitic steels do not behave in this way. They have very low magnetic permeability, with values of relative permeability around 1.005. Ferritic and martensitic stainless steels in contrast have relative permeability values around 15. With this very low relative permeability austenitic stainless steels can be used in equipment that very sensitive to magnetic field interference but also needs to be corrosion resistant. These applications include medical body scanner cases and naval mine sweeper vessel equipment. Grade 316LN (1.4406) with its additional nitrogen content is well suited to such applications. It should be noted that work-hardened austenitics can be slightly magnetic.

Recycling and the Environment

Stainless steels are 100% recyclable and have been traditionally recycled for making new steel.

Unlike carbon steels, which rely on paint or galvanized (zinc) coatings for their corrosion protection, stainless steels are not normally coated as they already have their own corrosion resistant surface. Reprocessing may only involve sorting the scrap material to optimize the use of expensive alloying additions such as nickel and molybdenum or removing surface oil and grease, left on from machining or forming processes.

This means that the costs of reprocessing scrap stainless steel can be kept lower than coated metals.

Some additional alloying is usually necessary in the steelmaking process however. About 80% of the newly made stainless steel produced in by western European steelmakers comes directly from the recycled scrap material.

Provided that appropriate grades of stainless steel are selected for their many applications, they should give long product service lives that require only a minimal level of maintenance. This means that whole life cycle cost benefits of using stainless steels can often be better than materials with lower initial costs, reducing unnecessary damage to the environment.

A particular example of the life cycle cost benefits of stainless steel is its use as reinforcing bar in high cost maintenance applications such as concrete tidal river or motorway bridges.

Selection of Stainless Steels

The main reason for considering stainless steels for any application is their corrosion resistance with other properties usually being secondary.

These include:

- Mechanical and physical properties
- Available forming, fabrication and joining techniques
- Environmental and material costs

The basic approach is to consider grades with as low a cost as possible, but the required corrosion resistance. After this other properties can be considered.

The lowest cost steels, subject to availability, should be those with the leanest compositions. This should initially encompass the straight chromium ferritic and martensitic grades, such as 410S (1.4000) or the 1.4003 type. Increasing the chromium (Cr) content will enhance the corrosion resistance, so a 17%Cr 430 (1.4016) grade can be expected to be a better choice, if needed. Similarly martensitic 431 (1.4057) grade with 15%Cr can be expected to have better corrosion resistance than the 12% Cr 420 (1.4021/1.4028) types.

In addition to this basic rule, nickel (Ni) additions support the corrosion resistance provided by the chromium and so widening the scope of service environments that these stainless steels can be used in.

The 2%Ni addition to the 431 (1.4057) martensitic improves corrosion resistance marginally. Normally to significantly improve corrosion resistance larger nickel

additions are made, austenitic grades having between 7-13% Ni and the more exotic grades up to 30%Ni. These nickel additions are also responsible for the change in the steels structure from ferritic to austenitic. Structurally, between the ferritic and austenitic family grades are the duplex steels, with

typically 3.5-6.5% Ni. Most of their corrosion resistance is derived from their chromium, molybdenum and nitrogen contents. The main function of the nickel is to “balance” the structure, which provides enhanced strength and resistance to stress corrosion cracking (SCC).

Some of the selection issues are summarised in the table, below:

Family	Example Grades	Advantages	Limitations
Ferritic	410S (1.4000) 430 (1.4016) 446 (1.4749)	Low cost, moderate corrosion resistance & good formability.	Nominal corrosion resistance, formability, weldability & elevated temperature strength.
Austenitic	304 (1.4301) 316 (1.4401)	Good corrosion resistance and cryogenic toughness. Excellent formability & weldability. Widely available.	Work hardening can limit formability & machinability. Limited resistance to stress corrosion cracking.
Duplex	2205 (1.4462)	Good mechanical strength. Very good pitting, crevice and stress corrosion cracking (sc) resistance.	Application temperature range more restricted than austenitics. More expensive, and less widely available than austenitics.
Martensitic	420 (1.4021) 431 (1.4057)	Low cost, hardenable by heat treatment with high hardness.	Nominal corrosion resistance. Limited formability & weldability.
Precipitation hardening	17/4PH (1.4542)	Strengthenable by heat treatment giving better toughness and corrosion resistance than martensitics.	Restricted availability, corrosion resistance & formability. Weldability better than martensitics.

Applications for Stainless Steels

The applications for stainless steels are extremely diverse. Typical applications can be illustrated for each of the family groups.

Ferritic Stainless Steels

- Vehicle exhausts
- Indoor architectural trim and panels
- Domestic appliances
- Low cost cooking utensils
- Food serving counters and furniture
- Bulk handling equipment

Austenitic Stainless Steels

- External architectural structures and cladding
- Building roofing, gutters and down-pipes
- External architectural metalwork (handrails, stairways, seating)
- External doors, fire doors and window frames
- Concrete reinforcing bar
- Fasteners (nuts and bolts)
- Food and drink manufacturing and processing equipment
- Domestic and retail catering equipment and sinks
- Water treatment, plumbing equipment and tubing
- Oven and furnace equipment
- Chemical processing and transport tanks

Martensitic Stainless Steels

- Cutlery
- Food preparation blades and kitchen knives
- Surgical instruments
- Pump and drive shafts
- Springs



Duplex Stainless Steels

- Pressure vessels
- Heat exchangers
- Lightweight bridge structures
- Off-shore oil and gas installations
- Ship's tanks and blast walls
- Chemical and petrochemical plant
- Brewery sparge tanks
- Food pickling plant and tanks

Precipitation Hardening Stainless Steels

- Aircraft and aerospace components
- Turbine blades
- Off-shore equipment & components
- Field gun frames and armaments
- Military and high performance vehicle components



Stainless steels can be specified using well established standards that encompass a wide range of product forms and applications. Historically many countries of the world developed their own standards and grade number systems for metals and alloys, including stainless steels. The main standards that are used in the UK are European, British and American. Since 1995 Britain has been in the process of adopting European Standards, replacing the "BS" British Standards with "BS EN" standards for many stainless steel product forms. The American ASTM and ASME standards continue to be used for some products, in particular pipe, tube and fittings. Similarly the American (AISI) grade numbers e.g. "304" continue to be used by many people dealing with stainless steels in the UK on a daily basis. For specification purposes the European steel numbers e.g. "1.4301" should now be used unless, in special cases, the project or system design is specifically to the American ASME code or for export to the US or Far East.

Specifications for Stainless Steel Products

The main standards for stainless steel products in the UK are British Standard versions of European Standards. These standards are identical in all countries of the expanding EC and have to be adopted by all member states when they are introduced. Each country is allowed to publish translated versions through their own standardising agency. In Britain we use them as "BS EN" standards. The main standard that defines stainless grades is BS EN 10088-1. This was republished in 2005 and now includes corrosion resisting, heat resisting and creep resisting steels.

The main British Standards for stainless steels include:

- BS EN 10088-1 – List of Stainless Steels
- BS EN 10088-2 – Sheet, Plate and Strip
- BS EN 10088-3 – Bars, Rods, Wire, Sections and Bright Products
- BS EN 10296-2 – Welded Tubes
- BS EN 10297-2 – Seamless Tubes
- BS EN 10095 – Heat Resisting Steels

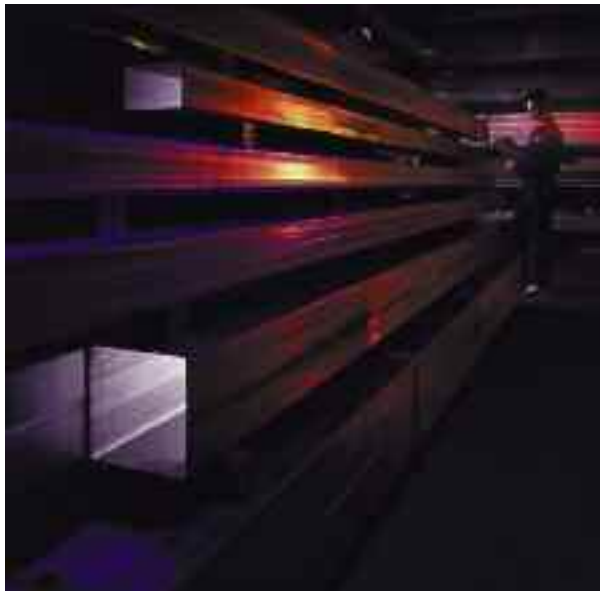

Most stainless steel product forms for general engineering and pressure purposes have now been incorporated into European Standards and the former British Standards withdrawn. Products like hollow bars (BS 6258) and concrete reinforcing bars (BS 6744) however are not yet specified in European Standards.

American ASTM (American Society for Testing and Materials) Standards use either the AISI (American Iron and Steel Institute) or UNS (Unified Numbering System) grade designations.

The AISI grades e.g. 304, 304L merely define the chemical composition ranges for these steels. They are not specifications for products like sheets, plates, bars, tubes etc. Products are specified in ASTM Standards, which usually cross-reference the UNS designations e.g. S30400, S30403. There is a wider range of ASTM Standards than European Standards for similar products. This is partly because the ASTM system has grown over the years whereas the European system was developed from scratch in 1995. The European standards system is no less comprehensive and should be easier to work with than the American standards.

The UNS system defines the grade compositions more precisely than the older AISI system. It is better for distinguishing between grade variants with different carbon or nitrogen contents. ASME (American Society of Mechanical Engineers) Standards are used for specifying coded pressure systems. The standard numbers are the same as the ASTM standards from which they are taken, but are prefixed with "SA" rather than the "A" of the ASTM for stainless steel products.

Examples of ASTM Standards include:

- ASTM A240 – Plate, Sheet and Strip
- ASTM A276 – Bars and Shapes
- ASTM A269 – Welded Austenitic Tubes for General Service
- ASTM A312 – Seamless and Welded Austenitic Pipes
- ASTM A789 – Seamless and Welded Duplex Tubes for General Service

Stainless Steel Grades

The grade numbers of the AISI system, which was adopted in British Standards during the 1960's, is an arbitrary 3 digit system, although the steel families are generally in the same groups i.e.

200 series – manganese/nickel austenitics e.g. 201
 300 series – nickel austenitics e.g. 304, 316, 321
 400 series – ferritics e.g. 409, 430 and martensitics e.g. 420, 431, 440C

600 series – precipitation hardening types e.g. 630 (17/4PH)

Duplex and super-austenitic stainless steel grades do not normally have AISI grade numbers, so are usually identified in ASTM Standards by either common names e.g. 2205, for the 1.4462 duplex steel or UNS numbers e.g. UNS S31254 for the 6% molybdenum "254SMO" super-austenitic.

The grade designation system used in European Standards was based on the German "Werkstoff-Nummern" e.g. 1.4301 for the AISI 304 type and 1.4307 for the AISI 304L type.

There is some logic to the way these numbers have been assigned to grades, but as with the AISI system it is largely a question of becoming familiar with the numbers. These "EN" steel numbers can be found in tables of related steel grades, showing the nearest AISI or old BS numbers.

The grade numbers used in the superseded British Standards are not however shown in the new BS EN standards, like BS EN 10088-1.

Throughout this brochure the grade numbers have been cross-referenced for brevity, e.g. 304 (1.4301).

What do the Standards Specify

The scope of available standards for stainless steel products varies, depending on the publisher (standardising authority) and the age of the original standard.

All standards have a list of steel grades and most show the acceptable chemical (cast analysis) composition ranges for the grades. Many standards also include ambient temperature mechanical properties, including tensile proof strength, maximum tensile strength (UTS) and elongation. Other important parameters like surface finish and size tolerances are normally included in either the product standard or related and referenced standards.

Other property parameters such as grain size and micro-cleanliness are rarely specified in standards. Physical properties like magnetic permeability, thermal expansion, density etc. are not included. If these are important to a purchaser, they have to be specified additionally at the time the steel is ordered.

The principal parameters included on stainless steel product standards include:

Chemical Composition



The ranges shown for each element e.g. carbon, chromium, etc. must be met from the steelmakers declared laboratory analysis of the cast from which the batch of product was made. Standards usually only require a range of elements that are important for the finished steel to meet the desired corrosion resistance and specified properties. For example molybdenum and titanium would not be shown on a mill certificate for a grade 304 (1.4301) product, but would be required for 316 (1.4401) i.e. the Mo, or 321 (1.4541) i.e. the Ti.

Product check analysis tests are not required by specifications and if needed must be ordered. Usually however standards give the acceptable deviation ranges from the cast analysis for any product check figures obtained. Only the specified elements for the particular grade need be checked by the product analysis.

Tensile Properties

Parameters measured in routine tensile tests that are normally included in standards are:

- 0.2% proof strength – Mpa (N/mm²)
- 1.0% proof strength - Mpa (N/mm²)
- Tensile strength (UTS) - Mpa (N/mm²)
- Total Elongation (after failure) - %

Hardness

The requirements for separate hardness testing are not included in most modern stainless steel product standards. Older standards did tend to include hardness. There are no units of hardness, with the level of hardness being represented as an integer.

When specified the methods involved include:

- Vickers – VPN (HV)
- Brinell – HB
- Rockwell B/C – HRB/HRC

Mill test certificates sometimes show hardness values from tests using the Rockwell B method, converted to the Vickers scale.

Impact Toughness

Charpy impact tests are specified for a limited number of grades and products. The standard test is done on a 10mm section and so thinner section products e.g. sheet, strip, tubes cannot normally be tested for impact strength. The test is sensitive to temperature and so the standards will generally specify an impact energy minimum for a specific temperature. The test units are normally Joules (J).

Corrosion Resistance

Rigorous corrosion testing is not required by stainless steel product standards.

The only corrosion test included in most product standards is for the susceptibility to intergranular (intercrystalline) corrosion, abbreviated to either IGC or ICC. Both European and ASTM standards have a testing standard for IGC / ICC (EN ISO 3651 in Europe or ASTM A262 in the US). Product standards will normally show if the test is required for each grade as a "yes/no" or "OK" criteria.

Other corrosion tests can be specified by order but are only normally requested if it is important to demonstrate that the product will meet some specific or exacting service requirement.

These tests include:

- Critical Pitting Temperature
- Salt Spray Atmosphere Resistance
- Huey Test (boiling nitric acid ICC susceptibility)

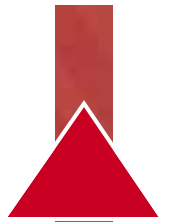

Other Tests for Stainless Steel Products

There are many other tests that may be relevant to the intended product application. Some are covered by separate testing standards, but tests not included in the product standard must be stipulated on the steel order.

These include:

- Physical Properties (Magnetic permeability)
- Mechanical Properties (Sub-zero or elevated temperature tests or to verify heat treatments)
- Steel Structure (Grain size, ferrite level, micro-cleanness)
- Corrosion Tests (CPT, salt spray)
- Surface & Internal Soundness (Eddy current, Dye-penetrant, Ultrasonic, X-Ray)
- Surface Finish (Normally Ra surface roughness CLA test)
- Surface Cleanliness and Passive Condition (Generally on fabricated products only)



Certification of Stainless Steel Products

To meet ISO 9000 and related quality standard requirements most stainless steel mills now provide "Certificates with Goods", so that products being delivered can be verified at the point of receipt. European and hence British Standards define material certificate types in BS EN 10204. Material test certificates supplied by stainless steel manufacturers usually show this standard.

Normally the 3.1 Inspection (or batch) certificate type, previously known as 3.1B, is supplied.

Stainless steel products are often stocked with "dual" certificates so that their range of application standards is flexible. Dual certification is not covered by any standards and so if required, it must be ordered. Where the application standard and grade is specific however, receiving dual certificates does not disqualify the certificates, provided of course they covered the required standards and grades. Dual certificates can

provide two distinct options, each having more than one set of:

- Standards (e.g. for sheet BS EN 10088-2 and ASTM A240 or ASME SA 240)
- Grades (e.g. 1.4301/1.4307 or 304/304L for standard and low carbon variants)

These can also be combined, for example:

BS EN 10088-2 1.4301/1.4307, ASTM A240 / ASME SA 240 304/304L

This means that the batch of sheets supplied has a chemical analysis and specified mechanical property values that meet BOTH grades in BOTH standards. It does not necessarily mean that ALL the specified parameters (e.g. dimensional tolerances, mechanical test methods etc.) meet both standards. If full compliance to a particular standard is required then a single standard certificate for the products should be requested.

European Directives and COSHH

In addition to European Standards there are restrictions on the supply of products stipulated in European Directives. Although these apply to stainless steels, they do not significantly affect the supply of commercially available products. The main directives of interest are:

Restriction of Hazardous Substances (RoHS)

Waste Electrical and Electronic Equipment (WEEE)

End of Life Vehicles (ELV)

"Nickel Directive"

These first three directives put restrictions on the amounts of lead, cadmium, mercury and hexavalent chromium that products are allowed to contain. A review done by some of the steelmakers has confirmed that the levels of lead, cadmium and mercury present in their stainless steel products is well below the maximum levels required by the directives. This should also be the case for commercially available stainless steels from reputable sources. The chromium in stainless steels is NOT in the hexavalent state and so the restrictions in the EU directives are not relevant.

The nickel directive, as it is known, only applies to products that are intended for use either in intimate, prolonged contact with human skin, or for products used during or immediately after body piercing operations.

Nickel contact dermatitis has only been connected with stainless steel in a very few isolated cases and then only in specific steel processing/fabrication environments.

In addition to the European directives, UK health and safety law requires that a supplier of stainless steel products, that could be converted into articles (i.e. parts or fabrications), should provide a "MSDS" (Materials Safety Data Sheet) to demonstrate that there is adequate "COSHH" (Control of Substances Hazardous to Health). These MSDS data sheets should be available from the steelmakers.

In normal handling, storage and use stainless steels should not be a chemical hazard concern.

The corrosion resistance of stainless steels is the key to their successful use. To perform well in the wide range of environments that stainless steels are used in, the “enemy” corrosion must be understood by specifiers, designers, suppliers and end-users.

Corrosion is a mechanism of electro-chemical disintegration that most metals and some other materials can suffer from. It can occur at both ambient and elevated temperatures, where the mechanisms differ. At ambient temperatures the mechanisms are dependent on electrically conductive moisture and so are known as “aqueous corrosion”. Elevated temperature attack mechanisms rely on the semi-conductive properties of the scales formed on the metal surfaces. Much of the stainless steel used operates around ambient temperatures, so aqueous corrosion mechanisms are of most interest.

The Stainless Steels Passive Layer

Stainless steels rely on their naturally forming passive surface layer for their corrosion resistance.

Although this layer forms rapidly under the right conditions, it cannot be regarded as permanent coating that is impermeable to all chemicals that might be present at the surface, like an indestructible invisible paint layer. The resistant properties of the passive layer depend on the chromium level and the presence of other alloying elements in the steel, but the layer can be broken down, and the steel become “active”. The steel surface will then suffer corrosion if it continues to be exposed to these conditions.

General or Localised Corrosion

The passive layer, when intact, guards against overall attack, or general corrosion, to the surface. This is one of the features that distinguish stainless steels from low alloy and carbon steels, which form a general rust layer on their surfaces as they corrode in the presence of moisture and oxygen. The oxygen in the moisture is needed in the rusting process on these steels, but in stainless steels it actually helps promote their corrosion resistance by maintaining the passive layer. Although stainless steels can suffer from overall surface or general corrosion, local attack mechanisms are a much more common problem.

If for some reason the passive layer is weak at a particular spot or is mechanically broken in a small area, then corrosive attack can start. This is very often due to chloride “ions” in the surrounding aqueous media migrating to the metal surface through the defective area of the layer. Under these conditions the passive layer on the surrounding steel surface, whilst continuing to give protection here, promotes the localised corrosion mechanism that has started in the pit now being formed.

Forms of Aqueous Corrosion

The main forms of aqueous corrosion that can affect stainless steels are related to each other, but to help avoid them they can best be understood as separate mechanisms:

- Pitting Corrosion
- Crevice (Shielding) Corrosion
- Stress Corrosion Cracking (SCC)
- Bimetallic (Galvanic) Corrosion
- Intergranular (Intercrystalline) Corrosion (IGC)

Pitting Corrosion

Pitting corrosion can be initiated at surface defects already present in the steel, for example non-metallic

inclusions, residual surface scale or large precipitates just under the surface. These defects can disturb the passive layer locally, providing potential corrosion sites.

For this reason, the steel used must always be:

- Properly descaled i.e. free of mill scale
- Sourced from reputable steelmakers who use good, clean steel making practices
- Heat treated to avoid unnecessarily large precipitates (including carbides)

Re-sulphurised “free-machining” stainless steels e.g. 303 (1.4305) can be more prone to pitting corrosion than non-treated grades of the same basic composition i.e. 304 (1.4301) in this case. The free-machining grades should only be used where absolutely necessary for very high unit production speeds as the service performance of the components can be compromised.

The pitting resistance of stainless steel grades can be compared from their compositions using Pitting Resistance Equivalent Numbers (PRENs). There are several formulae used to calculate PRENs, the most commonly used one for austenitic stainless steels is:

$$PREN = \%Cr + (3.3 \times \%Mo) + (16 \times \%N)$$

The basic reliance on chromium for pitting resistance is shown, but more important, the higher potency of molybdenum and particularly nitrogen in the steel for conferring pitting resistance on the steel. Using this formula the PRENs of commonly used grades can be compared:

Grade	%Cr	%Mo	%N	PREN
304 (1.4301)	17/19.5	N.S.	0.11max.	17.0-20.8
304LN (1.4311)	17/19.5	N.S.	0.12/0.22	18.9-0.22
316 (1.4401)	16.5/18.5	2.0/2.5	0.11max	23.1-28.5
316LN (1.4406)	16.5/18.5	2.0/2.5	0.12/0.22	25.0/30.3

A similar formula can be used to compare duplex stainless steels, due to the higher potency of nitrogen in these steels:

$$PREN = \%Cr + (3.3 \times \%Mo) + (30 \times \%N)$$

Grade	%Cr	%Mo	%N	PREN
2304 (1.4362)	22/24	0.1/0.6	0.05/0.20	23.1-29.2
2205 (1.4462)	21/23	2.5/3.5	0.10/0.22	30.8-38.1
2507(1.4410)	24.0/26.0	3.0/4.0	0.24/0.35	37.7-46.5

Steels with a PREN of 40 or over are known as super-austenitic or super-duplex, depending on their family type.



Crevice (Shielding) Corrosion

Crevice corrosion is initiated in areas where the oxygen supply to the surface is restricted, compared to the surrounding, fully passive surfaces. This can happen at engineered or “designed-in” crevices, for example at bolted joints or beneath flanges or gaskets. Areas of the steel surface covered by dirt or debris deposits can also suffer from this form of attack, which is then sometimes called “shielding corrosion”. Coarsely ground or machined surfaces can also act as crevices and more easily trap dirt and debris from their surroundings, which promotes crevice attack.

The mechanism is similar to that in pitting corrosion but is influenced more by the surroundings than the surface condition or internal structure of the steel.

Both pitting and crevice corrosion attack mechanisms involve using chloride ions made available in the environment and acidity, generated by the corrosion process. The more the environment provides chloride ions and the lower its pH (i.e. more acidic) the more likely these forms of corrosion are. Increasing temperatures also promote these localised forms of attack.

The main factors promoting crevice (and pitting) corrosion are:

- Presence of defects or crevices
- Coarse surface finishes (shown by high Ra values) or poorly finished surfaces
- Stagnant conditions (low oxygen levels & risk of deposits forming)
- High chloride content of solution
- Acid pH of solution (values less than 2 are hazardous)
- Increasing temperatures

Grades with increasing levels of chromium, molybdenum and nitrogen offer better resistance to crevice corrosion. The nickel content also reinforces the corrosion resistance, although it does not feature in the PREN formulae.

As a general rule stainless steels such as the 6% molybdenum austenitics can be expected to give the best resistance to crevice corrosion attack.



As a guide, some common stainless steels, rated in decreasing resistance to crevice corrosion are:

- 6% Mo austenitic (1.4547)
- 2205 (1.4462)
- 904L (1.4539)
- 316 (1.4401/1.4436)
- 304 (1.4301)
- 430 (1.4016)

Stress Corrosion Cracking (SCC)

Stress corrosion cracking requires three components for it to attack:

- Tensile stress
- Chlorides in the environment
- Temperature



All three of these components must be present for SCC to take place. Theoretically, removing any of these parameters eliminates the risk of SCC. Traditionally temperatures below 60°C were thought not to support SCC, but experience in very aggressive modern swimming pool building environments has shown that SCC can attack some stainless steels at lower temperatures.

Tensile stresses can be either **applied** i.e. by loading a structure or component or **residual** from thermal contraction following heat treatment or welding or overheating during grinding or machining. Often SCC attack goes hand-in-hand with crevice or pitting, as the tips of the pits formed by these processes act as stress raising points in the metal.

Selecting grades to avoid pitting and crevice corrosion can help reduce the risk of SCC attack, but the common austenitic grades with nickel contents around 8% i.e. 304 (1.4301) are particularly susceptible to SCC, due mainly to their austenitic structure. For this reason the ferritic and duplex grades are much better choices for resisting SCC attack. Increasing the nickel content and/or improving the pitting resistance through molybdenum and nitrogen additions gives better resistance to SCC.

Stainless steels that can be considered where SCC is a particular hazard include:

444 (1.4521) ferritic (2%Mo)
 2205 (1.4462) or any of the duplex grades
 904L (1.4539) austenitic (24%Ni)
 6% Mo (1.4547) super-austenitic (18%Ni, 6%Mo, 0.2%N)

Where feasible, stress relief heat treatments can also be used to help reduce the risk of SCC attack to the lower alloyed austenitic grades.

Bimetallic (Galvanic) Corrosion

Bimetallic or galvanic corrosion can occur when two different metals or alloys are joined and are in mutual contact with an electrolyte (liquid that can conduct electricity). The corrosion takes place on the least noble of the metals, whilst the more noble metal is effectively protected. Metals and alloys can be ranked in order of their nobility, depending on the electrolyte, in electrochemical or galvanic series tables. Stainless steels in their normally passive conditions are usually noble compared to most common metals that they come into contact with, including aluminium, copper, brasses, bronzes and zinc. As a result stainless steels do not normally suffer from this form of corrosion, but contact with galvanized steel can cause bimetallic corrosion to the zinc coating. This can occur in some external building applications where the two metal types come into contact.

To avoid bimetallic corrosion one or more of the following measures should be taken:

- Keep the junction dry
- Electrically insulate the metals (e.g. neoprene gaskets or washers)
- Apply a protective coating to the metal couple (e.g. paint or sealant)
- Use a design where the less noble metal has the larger surface area



Intergranular (Intercrystalline) Corrosion (IGC)

Austenitic and, to a lesser extent ferritic stainless steels can be susceptible to intergranular, or intercrystalline corrosion. This form of attack was originally associated with welding and was known as “weld decay”. Heat from the welding process caused chromium carbides to form in the weld heat affected zone (HAZ), locally

reducing the chromium level in the grain boundary regions, where the carbides could form most easily. Here the chromium level could be below the level needed to support the passive condition, locally so enabling localized grain boundary region attack.

This was avoided when the “stabilized” grades were introduced:

- 321 (1.4541)
- 347 (1.4550)
- 316Ti (1.4571)
- 430 Ti (1.4520)

The stabilising titanium or niobium additions tie up the available carbon as carbides that are more stable than chromium carbides thus preventing their formation when heated.

Alternatively, in practice the low carbon grades (i.e. below 0.030%) can be used, but unlike the stabilized grades they are not classed as being immune to this form of corrosion. Most duplex, super-duplex and super-austenitic grades have carbon contents specified low enough to avoid intergranular corrosion.



Selection of Stainless Steels to Avoid Corrosion

Corrosion tables for a wide range of service environments are published by the leading stainless steel producers and can be accessed via the BSSA web site, www.bssa.org.uk

These usually show steel grades that can be considered for combinations of chemical concentration and temperature and show if pitting or stress corrosion cracking are likely additional hazards.

To avoid corrosion in the application of stainless steels the following grade selection points should be considered:

- Select an appropriate grade, consistent with minimum cost
- Molybdenum and nitrogen in the steels improve pitting and crevice corrosion resistance
- Ferritic, duplex or high nickel grades are better choices if SCC attack is likely
- Super-austenitic grades should be considered for severe SCC risk areas, such as swimming pool building interiors
- Low carbon grades (except in the case of martensitic steels) are preferable to avoid IGC

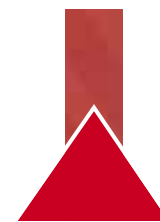

Surface Finishes

Although the appearance of the surface is important in getting the desired aesthetic effect on stainless steel components, it is important to remember that stainless steels rely on their surface properties to give them their corrosion resistance.

Specifying an appropriate surface finish on a stainless steel component is almost as important as selecting the right grade for the service environment.

As a general rule, to optimise corrosion resistance the smoothest, most crevice free surface possible should be specified.

Appearance, Corrosion Resistance and Cleanability



The attributes of appearance, corrosion resistance and cleanability of stainless steel surfaces are bound together. The metal surface is normally intended to be exposed and not dependent on additional surface protection (e.g. paint or plating) for its corrosion resistance. This usually means that it is expected to have good visual appeal as well as the required corrosion resistance. In food industry and medical applications the surfaces must also be readily cleansable, be well suited to automated cleaning systems (i.e. CIP or Clean in Place technology) and not trap or retain dirt, soil or bacteria at any time in their operating or cleaning cycles. Architectural applications also depend on the ability of surfaces not to trap dirt and to have a certain amount of "self-cleaning". With careful design detailing and ensuring that the "grain"

The available standards help define surface finishes, but it is difficult to specify a surface finish precisely. Using just a grinding or polishing grit size e.g. "a 240 grit finish" is not adequate. There are a large number of surface parameters that can be used when trying to accurately and fully specify a surface finish. These do not usually make it possible to fully specify measure and reproduce the desired finish.

In practice comparative reference samples should always be used to help specify surface finishes on stainless steel products.

direction of mechanically finished surfaces is vertical, rainwater can be used to help keep the surfaces clean, corrosion free and extend the times between routine cleaning operations.

Surfaces of food and pharmaceutical manufacturing equipment, in particular, must not contaminate the products being processed or handled. Coated surfaces can degrade and shed foreign material, the unprotected surfaces then exposed, corrode allowing corrosion products to get into the system.

For these reason stainless steels, correctly specified, designed, fabricated, surface finished and operated are the material of choice for not only for food and drink manufacturing, but a wide range of architectural and process industries.

Mill Finishes

Mill finishes are the starting point for specifying finishes on stainless steel products. Often ex-mill finishes, without any further finishing, can be suitable and appropriate for stainless steel products, particularly where the aesthetics of appearance are not important considerations. This can save cost without compromising product performance.

Mill finishes are categorised by their manufacturing routes and are broadly divided into:

- Hot Rolled (1)
- Cold Rolled (2)

These finishes are defined in stainless steel product standards for flat products (BS EN 10088-2) and long products (BS EN 10088-3) and are summarized below:

HOT ROLLED FINISHES			
BS EN Code	Finishing Process	Characteristics	Typical (Ra) micro-metres
1C	Hot rolled, heat treated, not descaled	Surface covered with mill scale suitable for heat resisting applications as supplied. Must be descaled to optimise aqueous corrosion resistance	-
1E	Hot rolled, heat treated, mechanically descaled	Freed of mill scale by shot blasting or grinding. Surface can have limited crevice corrosion resistance	-
1D	Hot rolled, heat treated, pickled	Most common 'hot rolled' finish available. Most corrosion resistant hot rolled finish	4-7
1U	Hot rolled, not heat treated, not descaled	Surface is left covered with rolling (mill) scale. Surface only suitable for products intended for further working.	-

COLD ROLLED FINISHES			
BS EN Code	Finishing Process	Characteristics	Typical (Ra) micro-metres
2B	Cold rolled, heat treated, pickled, skin passed	Most common 'cold rolled' finish available. Non-reflective, smooth finish, good flatness control. Thickness range limited by manufactures' skin passing rolling capacity.	0.1-0.5
2C	Cold rolled, heat treated, not descaled	Smooth but with scale from heat treatment. Suitable for parts to be machined or descaled in subsequent production, or for heat resisting applications.	-
2D	Cold rolled, heat treated, pickled	Similar to 2B in thicker sheet size ranges. Not as smooth as 2B.	0.4-1.0
2E	Cold rolled, heat treated, mechanically descaled	Rough and dull. Appropriate on steel types that are difficult to descale using pickling solutions.	-
2H	Cold rolled, work hardened	"Temper" rolled. On austenitic types improves mechanical strength. Smoothness similar to 2B.	-
2R (Formerly 2A/BA)	Cold rolled, bright annealed	Highly reflective "mirror" finish, very smooth. Manufactured items can be put into service without further finishing.	0.05-0.1
2Q	Cold rolled, hardened and tempered, scale free	Only available on martensitic types e.g. 420 (1.4021). Scaling avoided by protective atmosphere heat treatment. Can also be descaled after heat treatment.	-

Special Finishes

Special finishes are also defined in the BS EN 10088 standards. These can be produced either at the manufacturing mills or by specialist stainless steel processors.

These finishes can be applied to material produced as either:

- Hot Rolled (1)
- Cold Rolled (2)

Some of these special finishes are only available on cold rolled material i.e. code 2.

Codes 1 or 2 indicate that the starting material can be either hot or cold rolled.



BS EN Code	Finishing Process	Characteristics	Typical Grit	Typical (Ra) micro-metres
1G or 2G	Ground	A unidirectional texture, not very reflective.	120	-
1J or 2J	Brushed or dull polished	Smoother than "G" with a unidirectional texture, not very reflective.	180 240	0.2-1.0
1K or 2K	Satin polished	Smoothest of the special non-reflective finishes with corrosion resistance suitable for most external applications.	320	less than 0.5
1P or 2P	Bright polished	Mechanically polished reflective finish. Can be a mirror finish.	600 800	less than 0.1
2F	Cold rolled, heat treated, skin passed on roughened rolls	Uniform non-reflective matt surface, can be based on either 2B or 2R mill finishes.		-
1M or 2M	Patterned	One side patterned only. Includes "chequer" plates ("1" ex-mill finish) & fine textures finishes ("2" ex-mill finish).		-
2W	Corrugated	Profile rolled (e.g. trapezoidal or sinusoidal shapes).		-
2L	Coloured	Applied to flat (2R, 2P or 2K type fishes) or patterned (2M) sheet base finishes in a range of colours.		-
1S or 2S	Surface coated	Normally coated on one side only with a metallic coating, such as tin, aluminium or titanium.		-

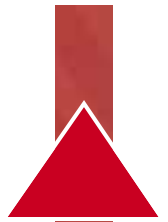

Comparison of Mill Finishes

The table shows how the BS EN 10088-2 flat product codes compare with the superseded BS 1449-2 and DIN (German) codes and the current ASTM A480 codes, for flat products.

BS EN Code	Description	BS 1449-2	DIN	ASTM
1D	Hot rolled, heat treated, pickled	1	IIa (c2)	1
2B	Cold rolled, heat treated, pickled, skin passed	2B	IIIc (n)	2B
2D	Cold rolled, heat treated, pickled	2D	IIIb (h)	2D
2R	Cold rolled, bright annealed	2A	III d (m)	BA
2G	Cold rolled, ground	3A	-	No.3
2J	Cold rolled, brushed or dull polished	3B (or 4)	-	No.4
2K	Cold rolled, satin polished	5	-	No.6
2P	Cold rolled, bright polished	8	-	No.8

Mechanically Abraded Finishes

Mechanical finishes for stainless steels are defined as finish codes G, J, K and P in BS EN 10088-2. Terms grinding, polishing, brushing and buffing even when used along with these codes, are not sufficient to accurately define the finish. There can often be confusion about what these terms mean.

Grinding and Polishing

Both grinding and polishing involve the deliberate removal of metal from the surface using an abrasive. The resulting surface will have some directional marks, partially dependent on the grit size of abrasive used. In the case of the very fine abrasives used in polishing it should only be possible to see any 'directional marks' under a microscope. Viewed normally 1P/2P finishes should appear non-directional.

There is no accepted definition of an abrasive grain or grit size that differentiates grinding from polishing. As a guide however, grit sizes of 80 and coarser are normally associated with grinding.

Grit sizes of 120 and finer are used in preparing polished finishes. Like polishing, which always involves using successively finer abrasive grit sizes to obtain the desired final finish, grinding can also involve more than one abrasive grit stage.

The final grit size used in both grinding and polishing does not fully define the finish and must not be used in an attempt to specify a ground or polished finish on stainless steel. Other parameters such as abrasive pressure, contact time, material feed rate and whether the operations are done dry or wet all affect the character of the finish produced.

Mechanical finishes merely described as 'satin' or 'polished' can vary quite significantly between mechanical finishing contractors.

OTISHEEN® is an example of proprietary fine satin finish with an attractive lustre and smooth finish. Its unique "clean-cut" surface is produced using fine abrasives and a special cutting compound.

The correct choice of steel grade is also important when a bright polished finish is required. The 321 (1.4541) and 316Ti (1.4571) grades which contain small amounts of titanium, should not be used if a



completely defect-free mirror polished finish is required. "Flaky" surface defects are likely to be left after polishing as the hard titanium carbide particles are dislodged from the softer surrounding steel surface. When 2P finishes are required the alternative 304L (1.4307) and 316L (1.4404) should be selected.

Brushing

Brushing normally involves the use of a fine abrasive action on the surface of the metal. In contrast to grinding and polishing there is no deliberate attempt to remove part of the surface. The surface is modified by the action of bristles or a nylon fabric medium (e.g. Scotch-Brite®) that may have some fine abrasive or lubricant added.

Although it can be a single stage process, following a suitable polishing preparation stage, brushing can be done in several stages to obtain a particular finish. Brushed finishes have the same special finish code, 2J in BS EN 10088-2 as dull polished.

Buffing

In buffing no attempt is made to remove metal from the surface. Buffing is only intended to smooth and brighten the existing surface. Traditionally buffing uses cotton or felt based media, often with the addition of lubricants applied to the buffing wheel.

Whenever buffing is being considered as the final finishing operation, it is important that the pre-treated (or existing) surface is defined and controlled. Buffing cannot be used as a substitute for polishing to obtain finishes such as 1P/2P on 'intermediate' abraded

ground or polished surfaces. It will only smooth down the surface and will not impart the same characteristics as if the surface has been abraded with successively finer grit sizes (i.e. as in polishing).

Buffing cannot be used as shortcut to obtaining a polished finish. If the surface that is going to be finished by buffing is too coarse, there is risk that traces of the underlying surface finish will be visible on the finally buffed surface.

There is currently no provision for specifying buffed finishes on stainless steel flat products in BS EN 10088-2.

BS 1449-2 (1983) in contrast defined two buffed finishes:

- No.3B - dull buffed
- No.7 - bright buffed.

The ASTM A480 standard also includes a No 7 bright buffed finish.

Applications for mechanically abraded stainless steel finishes

Mechanically finished stainless steel is widely used, including both internal and external building applications. The surface appearance, corrosion resistance and dirt retention of mechanically finished stainless steel surfaces can vary widely, depending, in part, upon the nature of the abrasive medium used and the polishing practice. The 1K/2K finishes are fine and clean cut, with minimal surface micro-crevices. This helps optimize the corrosion resistance and minimise dirt retention. These finishes are more suitable than the 1J/2J finishes for external applications, especially where service environments may be aggressive. The coarser 1J/2J and 1G/2G finishes, where required for their aesthetic appearance, are more suitable for indoor applications.

Brushed finishes are susceptible to damage, but scratches can be readily abraded out by competent surface restoring contractors. These surfaces do not fingerprint easily and so can be used in applications such as internal panels, doors and windows.

Atmospheric deposits and other forms of surface soiling can be washed away better on any uni-directionally polished or ground surface, if the abrasion direction is vertical.

Polished reflective surfaces are also susceptible to damage. Remedial polishing is possible but it is more difficult to get satisfactory results than on non-reflective finished surfaces.

Non-Directional Mechanical Finishes

Bead and shot-blasted finishes are produced by the impact of a hard, inert medium onto the steel surface. This gives a uniform, non-directional matt surfaces with low reflectivity. Bead blasting or peening gives a finish with a soft satin texture. Peening can also improve the stress corrosion cracking resistance of the steel surface as any small residual surface tensile stresses are replaced by compressive stress pattern.

The textures of the blasted surfaces vary with the blast media. These include glass, ceramic or lead bead, silicon carbide, aluminium oxide, stainless steel shot or

ground quartz. For architectural applications steel shot or glass bead peening methods are used for getting finishes with a non-directional surface sheen and the best corrosion resistance possible.

Surface blasting methods use an impacting medium that cuts the steel surface, removing small amounts of metal. The resulting surface finish and hence surface corrosion resistance of the treated stainless steel is partly dependant on the blasting medium. In contrast surface peening does not remove metal. The impact of the rounded bead peening medium produces small craters in the surface, giving a dimpled appearance.

Bead blasted finishes for stainless steels are not covered in BS EN 10088-2. The quality of the finish depends on the blast media, blast intensity and the coverage of the surface, but these alone cannot be used to specify the finish.

The specification should be agreed with a specialist surface contractor.

Applications for blasted stainless steel finishes include:

- Structural support members (e.g. external walkway support arms)
- Cast glazing fixing and connections
- Architectural external and internal cladding, facades and columns
- Sculptures and street furniture



Patterned Finishes

Stainless steel sheets can be given patterned rolled finishes. BS EN 10088-2 covers the specification of both hot and cold rolled products with a one side patterned only as special finish "M". This includes "chequer" plates ("1" ex-mill finish) and fine textures finishes ("2" ex-mill finish). The specific design of the patterns is not defined in the standard and has to be agreed.

These three-dimensional relief effect patterns can be produced by either texture rolling or pressing (embossing). BS EN 10088-2 only covers single sided patterns with a plain, flat surface on the reverse side. Products are also available with a reversed relief effect pattern on both sides. These are formed by rolling sheets through pairs of mating, matched male-female patterned rolls.



Matt rolled surfaces are defined as special finish "2F" by BS EN 10088-2. These finishes are produced by 'skin pass' rolling flat cold rolled stainless steel coil on roughened rolls, rather than on the polished rolls that are used to produce the smooth 2B finish. The 2F finish produced is a uniform non-reflective matt surface.

These patterned finishes are only produced at the manufacturing mill or at specialist processors, using patterned or textured rolls to form the surface features by cold rolling.

Patterned rolled sheets are more rigid than flat sheets, particularly in the austenitic stainless steels, where the work hardening characteristics of the steel are used to advantage. These relief patterned surfaces do not show finger-marks as readily as flat sheets. The finer texture patterns can also be used to reduce sliding friction and improve heat dissipation, compared to flat sheet products.



Applications for patterned rolled stainless steel sheets include:

- High traffic contact products (lift doors and panels, column cladding, ticket machines)
- Food and drink machinery
- Supermarket check-out desks
- Domestic appliance casings

Chemical Finishes

Stainless steel can be finished chemically or electro-chemically.

The main processes used include:

- Electropolishing
- Colouring
- Etching

Electropolishing

Electropolishing involves the anodic dissolution of a thin layer of the surface. It can be done on most metals including stainless steels. Approximately 20 to 40 micro-metres of the surface is removed leaving a smoothed surface that optimises the corrosion resistance and cleansibility of the component and reduces surface stresses left over from mechanical polishing pre-treatments. Any contamination and debris left on the surface by the mechanical surface pre-treatments are also removed during the electropolishing process. Electropolished surfaces should be fully passive after treatment. The polished surfaces show lower rates of bacterial growth, which is useful in food industry applications.

Scratches and other visible surface irregularities are unlikely to be removed by electropolishing.

Non-metallic inclusions at the surface of the steel may also be more visible after electropolishing, compared to the finish after mechanical polishing methods. Electropolishing can be used on castings as a check on the surface soundness.

Electropolished finishes cannot be specified using the BS EN 10088-2 or BS EN 10088-3 stainless steel standards.

The process is covered by:

- BS ISO 15730:2000-Metallic and other inorganic coatings. Electropolishing as a means of smoothing and passivating stainless steel

Colouring

Stainless steel can be coloured either by the application of paint or by chemical treatments. Paint systems rely upon introducing a second layer of material onto the surface whereas chemical systems rely upon altering the thickness and nature of the passive film on the stainless steel item. A particular attraction of chemically coloured stainless steel is that it appears to change colour under different shades and angles of artificial and natural light.

The process is normally restricted to cold rolled sheet products, and although it is possible to colour fabricated components. Chemical colouring of stainless steel sheet uses a mixture of chromic and sulphuric acids that develop the thickness of the naturally occurring passive film on the steel surface, depending on the immersion time.

The sequence of colours formed as the film grows in thickness produces a range that includes bronze, blue, black, charcoal, gold, red-violet and green. A wide range of pre-finished surfaces can be coloured. These include flat mechanically ground, polished (satin) or blasted finishes or roll-patterned surfaces. A charcoal colour effect can be produced by treating a satin polished sheet to the same conditions that normally produce a blue on non-polished sheet surfaces. Colouring can also be combined with acid etched patterns to provide an even wider range of textures, lustre's and reflective effects.

Only the best quality stainless steel sheet can be successfully chemically coloured.

A far less frequently produced 'blackened' finish can be produced by immersion in a fused sodium dichromate salt bath at around 400°C.

Coloured finishes can be specified through BS EN 10088-2 as special finish 2L (cold rolled material only)

Applications for coloured stainless steel sheet products include:

- Architectural external cladding (facades, columns, roofing etc.)
- Internal cladding in low traffic areas
- Signs and shop display panels
- Sculptures

Coloured stainless steel is difficult to repair if scratched which is why it is best suited to these applications where scratches and abrasion are unlikely.

Stainless steels are selected for applications where their inherent corrosion resistance, strength and aesthetic appeal are required. However, dependent on the service conditions, stainless steels will stain and discolour due to surface deposits and so cannot be assumed to be completely maintenance-free. In order to achieve maximum corrosion resistance and aesthetic appeal, the surface of the stainless steel must be kept clean. Aalco's OPTISHEEN® is a high quality satin finish which is easy to keep clean.

Preparation for the Service Environment

Pickling & Passivation

The terms pickling, passivation and descaling when applied to the maintenance of stainless steels are sometimes misunderstood.

Stainless steels are intended to naturally self-passivate whenever a clean surface is exposed to an environment that can provide enough oxygen to form the chromium rich passive surface layer. Passivation treatments are however sometimes specified for machined parts.

Stainless steels cannot be passivated unless the steel surface is clean and free from contamination and scale from operations such as welding. Scale may need to be removed first before the metal surface can be pickled (removal of metal surface by chemical dissolution).

Although the surface of freshly pickled stainless steel will normally be immediately passivated by the pickling acid, these two treatments are not the same. Pickling usually involves nitric/hydrofluoric acid mixtures. Passivation normally involves only nitric acid. Nitric acid will however remove light surface iron contamination.

There are 3 standards that deal with the passivation of stainless steel surfaces:

- ASTM A380 - Practice for Cleaning, Descaling and Passivating of Stainless Steel Parts, Equipment and Systems
- ASTM A967 - Specification for Chemical Passivation Treatments for Stainless Steel Parts (based on US Defense Department standard QQ-P-35C)
- BS EN 2516 - Passivation of Corrosion Resisting Steels and Decontamination of Nickel Base Alloys

Removing Heat Tint after Welding

Heat tinting is a thickening of the naturally occurring oxide layer on the surface of the stainless steel. The colours formed are similar to 'temper colours' seen after heat treatment of carbon steels, but occur at slightly higher temperatures. As the steel surface oxidizes chromium is drawn from below the surface of the metal to form more chromium rich oxide.

This leaves the metal just below the surface with a lower than normal chromium level and hence reduced corrosion resistance.

If the service application is at an elevated temperature then removal of heat tint is not important as some oxidation heat tinting is likely on the surface during service and will blend into any localised weld tinting.

Where the application requires the steel to have ambient temperature "aqueous" corrosion resistance then visible heat tint should be removed. This will restore the surface corrosion resistance that the steel grade used is capable of providing.

The removal of heat tint from stainless steel fabrications can be done mechanically. Chemical methods should be used to finish the process or used as a single stage process.

These methods include:

- Brush-on pastes or gels
- Spray or immersion acid pickling
- Electrolytic methods

It is also important that hidden inside faces of welded fabrications are free of heat tint. Although these areas may be out of sight, they are likely to be in direct contact with the service environment for which the particular stainless steel grade was selected and so are just as important as the steel on the outside faces.

Weld backing gas systems should virtually eliminate inside weld tint but pickling these areas should still be part of good finishing practice and properly prepare the fabricated items for their service environment.

Iron Contamination and Rust Staining

Stainless steel supplied by reputable manufacturers, stockholders or fabricators will normally be clean and contamination free. These items should not show rust staining, unless contamination is introduced.

Using non-stainless steel processing and handling equipment when working with stainless steel can be a source of contamination. Work table bearers, lifting 'dogs' and chains can be some of the causes of rust staining. Non-metallic contact materials and vacuum lifting equipment should be used to avoid contamination during handling and fabrication. Cutting or grinding debris from working with non-stainless steels should not be allowed to settle on any stainless steel surfaces. As soon as any of this contamination becomes wet, rust staining is likely to develop.

Tests can be done if contamination is suspected. Some of the tests simply look for rust staining if the surface is wetted or exposed to high humidity environments. To detect the cause of rust staining i.e. free iron on the surface, rather than the effect, then the ferroxyl test should be used. This will detect either free iron or iron oxide directly and is sensitive enough, used correctly, to detect even small levels of contamination.

The test is outlined in the ASTM A380 standard, which also deals with methods for removing the contamination.

In practice phosphoric acid cleaners can be used to remove moderate iron contamination. These are usually effective if sufficient time and care is taken. Phosphoric acid will not usually change the appearance i.e. etch the surface.

Alternatively, dilute nitric acid will remove small amounts of embedded iron and make sure the cleaned surface is fully passive. Nitric acid will fully dissolve the contamination but can etch and so change the



appearance of the stainless steel surface if not used carefully. This may not be acceptable in cases where the surface is intended for its aesthetic appeal.

Cleaning and Maintenance in Service

Stainless steels are selected for applications where their inherent corrosion resistance, strength and aesthetic appeal are required. However, dependent on the service conditions, stainless steels will stain and discolour due to surface deposits and so cannot be assumed to be completely maintenance-free. In order to achieve maximum corrosion resistance and aesthetic appeal, the surface of the stainless steel must be kept clean. Provided the grade of stainless steel and the surface finish are correctly selected, and cleaning schedules carried out on a regular basis, good performance and long service life will result.

Factors Affecting Routine Maintenance

Surface contamination and the formation of deposits on the surface of the stainless steel must be prevented. These deposits may be minute particles of iron or rust generated during construction.

The surface should not be allowed to become contaminated with non-stainless steel or iron particles. The surface finish and orientation (if it is a directional finish) selected and the design of the components must minimise the risk of dirt entrapment and build up. OPTISHEEN® is a good choice of surface finish for avoiding dirt build up and so extending the times between routine cleaning. Coarser finishes will require more frequent cleaning. The particular application will also affect the maintenance requirements.

Industrial and even naturally occurring atmospheric conditions can produce deposits which can be equally corrosive, e.g. salt deposits from marine conditions. Working environments such as the heat and humidity in swimming pool buildings can also be very aggressive. These conditions can result in surface discolouration of stainless steels, requiring more frequent maintenance.

Architectural metalwork, cladding, catering equipment etc. that is touched and finger-marked will need more frequent routine cleaning to keep its intended look. The accessibility of the stainless steel surfaces will also affect the approach to maintenance and cleaning. Where items like external building cladding is going to be difficult and expensive to maintain, particular attention should be paid at the design stage to surface finish and design detail to help avoid, or at least delay the accumulation of dirt.

Specialist application equipment including food and drink manufacturing and processing and pharmaceutical manufacture usually involves special cleaning and sanitisation systems. These often involve clean-in-place (CIP) technology. Expert advice on design, selection, fabrication and surface finishing should be obtained so that the in-service maintenance regimes do not compromise the service performance of any stainless steel used in equipment for these applications.



Maintenance Programme

The frequency of cleaning is dependent on the application. A simple guideline is:

Clean the metal when it is dirty in order to restore its original appearance.

This may vary from once to four times a year for external applications, but may be daily for items in 'hygienic' applications. Recommendations on cleaning frequencies in architectural applications are shown below.

Location	430 (1.4016)	304 (1.4301)	316 (1.4401)
Internal	As required to maintain appearance or design		
Suburban or rural	6-12 month intervals (as appropriate to location and design)		
Industrial or urban	Grade not recommended	3-6 months	6-12 months
Coastal or marine	Grade not recommended	Grade not recommended	6-12 months

Routine Cleaning Methods

Stainless steel is easy to clean. Washing with soap or mild detergent and warm water followed by a clear water rinse is usually quite adequate for routine domestic and architectural equipment cleaning.

Where stainless steel has become extremely dirty with signs of surface discolouration (perhaps following periods of neglect, or misuse) alternative methods of cleaning may be needed.

Suggested cleaning methods are shown below.

Problem	Suggested Method	Comments
Routine cleaning of light soiling	Soap, detergent or dilute (1%) ammonia solution in warm clean water. Apply with a clean sponge, soft cloth or soft fibre brush then rinse in clean water and dry.	Satisfactory on most surfaces.
Fingerprints	Detergent and warm water, alternatively, hydrocarbon solvent.	Proprietary spray-applied polishes available to clean and minimise re-marking.
Oil and grease marks	Hydrocarbon solvents e.g. methylated spirit, isopropyl alcohol, and acetone.	Alkaline formulations are also available with surfactant additions.
Stubborn spots, stains and light discolouration. Water marking. Light rust staining	Mild, non-scratching creams or polishes. Apply with soft cloth or soft sponge, rinse off residues with clean water and dry.	Avoid cleaning pastes with abrasive additions. Suitable cream cleansers are available with soft calcium carbonate additions or with the addition of citric acid. Do not use chloride solutions.
Localised rust stains caused by carbon steel contamination	Proprietary gels, or 10% phosphoric acid solution (followed by ammonia and water rinses), or oxalic acid solution (followed by water rinse).	Small areas may be treated with a rubbing block comprising fine abrasive in a hard rubber or plastic filler. A test should be carried out to ensure that the original surface finish is not damaged. Carbon steel wool, or pads previously used on carbon steel should not be used.
Burnt on food or carbon deposits	Pre-soak in hot water with detergent or ammonia solution. Remove deposits with nylon brush and fine scouring powder if necessary. Repeat if necessary. Finish with using "routine cleaning".	Abrasive scouring powder can leave scratch marks on polished surfaces.
Tannin (tea) stains and oily deposits in coffee urns	Tannin stains – soak in a hot solution of washing soda (sodium carbonate). Coffee deposits - soak in a hot solution of baking soda (sodium bicarbonate).	These solutions can also be applied with a soft cloth or sponge. Rinse with clean water. Satisfactory on most surfaces.
Adherent hard water scales and mortar/cement splashes	10-15 volume % solution of phosphoric acid. Use warm, neutralise afterwards with dilute ammonia solution. Rinse with clean water and dry. Alternatively soak in a 25% vinegar solution and use a nylon brush to remove deposits.	Proprietary formulations available with surfactant additions. Take special care when using hydrochloric acid based mortar removers near stainless steel.
Heating or heavy discolouration	a) Non-scratching cream or metal polish b) Nylon-type pad, e.g. Scotchbrite® c) Nitric acid-hydrofluoric acid pickling pastes or a nitric acid passivation solution.	a) Creams are suitable for most finishes. b) Use on brushed and polished finishes along the grain. c) Changes in surface appearance usually result when cleaning with these acids.
Badly neglected surfaces with accumulated grime deposits	A fine, abrasive car body refinishing paste. Rinse clean afterwards to remove all paste material and dry.	May brighten dull finishes. To avoid a patchy appearance, the whole surface may need to be treated.
Paint, graffiti	Proprietary alkaline or solvent paint strippers, depending upon paint type. Use soft nylon or bristle brush on patterned surfaces.	Apply as directed by manufacturer.



Routine Cleaning Notes

Abrasives

- Non-scratch nylon abrasive pads can usually be used safely on most stainless steel surfaces. They may however scratch highly reflective surfaces.
- If wire brushes are used, these should be made from stainless steel.
- With directional brushed and polished finishes, align and blend the new "scratch pattern" with the original finish, checking that the resulting finish is aesthetically acceptable.
- Avoid using hard objects such as knife blades and certain abrasive/souring agents as it is possible to introduce surface scuffs and scratches.
- Ensure that all abrasive media used are free from sources of contamination, especially iron and chlorides.
- Before using an abrasive on a very prominent surface, try it out on a small, unobtrusive, hidden or non-critical area first to make sure that the resulting finish will match the original.

Cleaning Chemicals

- Chloride-containing solutions, including hydrochloric acid-based cleaning agents and hypochlorite bleaches can cause unacceptable surface staining and pitting on stainless steel surfaces.
- When bleaches are used for sanitising stainless steel surfaces they must be diluted and contact times kept to a minimum.
- Hydrochloric acid based solutions, such as silver cleaners, or building mortar removal solutions must not be used in contact with stainless steels.
- Superficial scratching can sometimes be removed with proprietary stainless steel cleaners or with a car paint restorer.
- Any proprietary cleaning agents used should be prepared and used in accordance with the manufacturers or suppliers' health and safety instructions.
- Solvents should not be used in enclosed areas.

Rinsing

- Use clean rinsing water to avoid water marks.
- Tap water is usually adequate.
- De-ionised water can be used to avoid drying streaks in hard water area.



Stainless steels can be formed, cut, machined and joined using a wide range of methods. Many of these methods are similar to those used on low alloy or carbon steels, but the properties of stainless steels mean that some of the process controls need to be adjusted. The most important issue however is that the inherent corrosion resistance of the stainless steel is not compromised by the fabrication method, tooling, handling or storage facilities used in the fabrication shop. Contamination must not be carried over from any processing of carbon steels on the same equipment.

Machines, tooling and handling equipment dedicated to use on stainless steels is preferable to avoid cross-contamination.

Stainless Steel Properties

Most standard stainless steels can be fabricated using suitable methods. The most significant phenomena that affects their fabrication, compared to low alloy steel, is their higher work hardening rates. This applies mainly to the austenitic family of stainless steels. The other families, particularly the duplex, martensitic and precipitation hardening steels have higher initial hardness and strength and so must be worked in their softened conditions.

To reduce tool wear and maintain machining cutting speeds, machinability enhanced or “free-machining” grades, as they are commonly known, can be used. Traditionally these grades have sulphur additions to help with chip-breaking and supply some solid lubrication to the surfaces being machined. Alternative compositions with calcium or copper additions are now available for improved machinability.

Sheet austenitic steels for deep-draw forming have been developed with enhanced nickel contents to delay the onset of work-hardening in the cold forming operation. Bar products for severe cold forming operations such as cold heading for the manufacture of fasteners are available. These have copper additions, which have a similar effect as nickel on the work hardening characteristics of the steel.

Cold Forming

Cold forming is the changing of the shape of a piece of metal without applying any heat to soften it, or removing any metal from the surface. Flat products (sheet and strip), long products (bar, rod and wire) and hollow products (tube and pipe) are widely cold worked in ferritic, austenitic and duplex stainless steels.

These methods include:

- Deep Drawing (sheet)
- Stretch Forming (sheet)
- Folding (sheet) and Bending (tube and bar)
- Cold Forging (fasteners)
- Drawing (wire)
- Cold Sizing (Rod, wire and tube)

Deep Drawing

The austenitic steels have the best deep drawing characteristics of the stainless steels, in spite of their tendency to work-harden. Ferritic steels draw well, but have lower ductility, limiting the depth of drawing and are more “anisotropic” i.e. their ductility in different directions of the sheet varies more than austenitic steels, resulting in wasteful “earring” at the edges of drawn parts. The superseded BS 1449:2 British standard for stainless sheet products had a grade 304S16, with a higher nickel range than the standard 304S15, specifically to enhance deep draw-ability. The

BS EN 10088-2 standard does not cater for this compositional difference and only has grade 1.4301 to cover all “304” variants. Steelmakers and suppliers however recognise the on-going need for this steel and if requested supply steel within the 1.4301 range, but with nickel towards the top of the range.

Stretch Forming

Stretch forming works by reducing the thickness of the walls of the drawn product. This mechanism is well suited to the strong work-hardening characteristics of austenitic stainless steels. Although extra power is needed to continue the drawing process, longer draw strokes are possible because of the work-hardening effect, without risking fractures in the stretched wall of the drawn component. Steel grades like 301 (1.4310) with a 6.0% minimum nickel have been developed specifically for making stretch formed panels. The manufacturing mill heat treatment can also be adjusted to optimise “stretch-formability”, if this forming method is specified by the customer before purchase.

Folding and Bending

The ductility and work hardening of the austenitic stainless steels makes these steels a good choice for folding and bending. Bend radii of around twice the diameter for softened bar, rod and tube are possible. These steels “spring-back” more than other steels after bending and so a greater over-bend allowance is needed to achieve the final angle of bend required. Higher initial forces are needed for bending ferritic and particularly duplex stainless steels than austenitic steels, due to their higher yield strengths. As they do not exhibit the same levels of work-hardening as the austenitic steels however, the pressing forces do not increase to the same extent.

Cold Forging

Cold forging is a very severe cold forming process and requires very good ductility and low work-hardening to avoid cracking in the forged component. Grade 1.4567 with a 3.0% copper addition to an 18%Cr, 8.5%Ni composition, is intended for these applications.

Cutting

Stainless steels can be cut by both cold methods including:

- Shearing (slitting)
- Sawing
- Water-jet Cutting
- Laser Cutting and thermal methods, such as Plasma arc

The cutting methods do not rely on specific stainless steel properties and most grades can be cut with these methods.



The high work hardening rates of the austenitic stainless steels requires more powerful and sturdier equipment for shearing operations. High quality blades that keep their sharp cutting edges are also needed for shearing and sawing. Deep, slow cuts with flood cooling to avoid overheating are the best way to deal with the work-hardening issue during sawing. Band-sawing is a better choice than hack-sawing. When hack-sawing, the blade must not be dragged back over the steel surface being cut, or the teeth will be dulled making the next cut more difficult due to the work-hardening effect on the cut surface.

Cold cutting methods are less prone to work piece distortion than thermal methods. This is particularly important when cutting austenitic stainless steels as they have thermal expansion rates 50% higher than ferritic steels. The low heat input of laser cutting makes it ideal for cutting stainless steel.

Thermal cutting stainless steels requires more heat than the cutting of low alloys steels. The cut surfaces must be protected from excessive scale formation and after cutting any scale on the edges should be removed to ensure that the corrosion resistance of the cut surface is restored. Oxy-acetylene "torch" cutting is not suitable for stainless steels.

Machining

The austenitic stainless steels are regarded by some fabricators as difficult to machine.

With sufficiently robust and powerful machine tools, high quality cutting tools with appropriate cutting angles and chip breakers, appropriate feed and speed cutting parameters and adequate work-piece cooling, most stainless steels can be machined without undue difficulty. Only where very high production rates and volumes are required should the enhanced machinability grades such as 303 (1.4305) be needed. The weldability and pitting corrosion resistance of this sulphurised steel is inferior to that of 304 (1.4301) grade, which should be used instead whenever possible.

Work-hardening austenitic grades during machining must be avoided by using a deep-cut, high feed, low speed approach, compared to low alloy steel machining.

The other families of stainless steel have good machinability if machined in their softened condition. They do require more cutting force than low alloy steels however due to their higher mechanical strengths.

Joining

Stainless steels can be joined by using a wide range of cold or "thermal" i.e. requiring heat, methods.

The main cold joining methods are:

- Riveting
- Bolting
- Adhesive Bonding

Thermal joining methods include:

- Soldering
- Brazing
- Welding

Cold joining is often less expensive and less prone to distort the finished components than the alternative thermal processes and can be used on all the families of stainless steels without disturbing their heat treated properties. The joint strengths, particularly riveted and adhesively bonded, are usually well below the strength of the surrounding metal. With careful design the strength of bolted joints can be significantly better, but to match the strength of the surrounding "parent" metal, full penetration seam welding is the only option.



Riveted and bolted joints can create crevices that can be sites for corrosion if the environment is severe. The correct grade of rivets, nuts, bolts and washers must be selected for the environment. If in doubt, use a more corrosion resistant grade than the steel being joined to avoid bimetallic (galvanic) attack on the fasteners.

Adhesive bonding tends to seal the joints, making them less prone to crevice corrosion attack than mechanical joining methods.

Soldering stainless steels is usually done at temperatures below 450°C, using either silver or copper alloy solders. Thorough surface preparation is essential. Any oil or grease must be removed and the surface abraded to remove any iron contamination and provide a key for the solder. Conventional hydrochloric acid based fluxes should not be used. Instead Phosphoric acid based fluxes should be used when soldering stainless steel.

Brazing is similar to soldering in that a dissimilar, lower melting point alloy is used to make the joint. The melting ranges are higher than in soldering and the joints produced are stronger.

To protect the joint during the joining process, brazing stainless steels can be done using either:

- Flux protection
- Controlled furnace atmospheres
- Vacuum furnace protection

Both soldered and brazed joints can suffer from bimetallic (galvanic) corrosion. These methods should not be used in service environments that approach the full corrosion resistance potential of the steel being joined.

Welded joints are capable of having strengths comparable with those of the parent metal parts. Properly executed and cleaned welded joints should also have matching corrosion resistance to the parent metal and should not normally suffer from crevice, pitting or bimetallic corrosion.

Most stainless steels can be welded. Austenitic and duplex grades are particularly suitable for welding. Ferritic stainless steels should only be welded in thin sections. Precipitation hardening grades are weldable but welding martensitic stainless steels is only feasible with the lower carbon content grades.

The austenitic and duplex stainless steels can be welded using a wide range of techniques.

This normally involves protecting the joint area from oxidation using either an inert gas (e.g. argon) cover or a molten flux. The exceptions are spot and stud welding, which can be done surrounded by air.

The methods used for welding stainless steels include:

Gas Protected

- TIG (GTAW) – Tungsten Inert Gas
- MIG (GMAW) – Metal Inert Gas
- MAG – Metal Active Gas
- AW – Plasma Arc Welding
- Laser Welding
- Electron Beam Welding

Flux Protected

- MMA (SMAW) – Shielded Manual Metal Arc
- SAW – Submerged Arc Welding
- FCW (FCAW) – Flux Cored Welding



No Protection

- ERW – Electrical Resistance Welding (seam and spot joints)
- Friction Welding (stud welding)

For general fabrication work the TIG, MIG and MAG are the most widely used methods.

Welding is usually best done with filler (essential with MIG, MMA and FCW), but in some situations can be done “autogenously” i.e. without a filler metal. Fillers, when used must be selected to match the corrosion resistance of the parent metal. Austenitic stainless steels are also frequently welded to low alloy steels, particularly in construction work. Careful selection of “over-alloyed” filler metals is important when dissimilar metal welding to avoid the finished weld being brittle or it cracking during cooling.



The Core Product Ranges are:

Plate

CPP Plate to BS EN 10088-2, ASTM A240 & ASME SA240.
 Quarto Plate to BS EN 10088-2, ASTM A240 & ASME SA240.
 Cold Rolled & Descaled Plate to ASTM A240 & ASME SA240 in grades 304L & 316L thicknesses 2mm to 6mm thick. 1.4003 Plate 2mm to 6mm thick.

Sheet

1.4016 (430) & 1.4301 (304) Bright Annealed Sheet 0.5 to 2mm thick.
 2B Sheet 0.5 to 3mm thick in grades 1.4016 (430), 1.4301 (304) & 1.4401 (316).
 1.4003 Sheet 1mm to 2.5mm thick, 2B finish.
 240 Grit Polished & White Poly-Coated Sheet in grades 1.4016 (430), 1.4301 (304) & 1.4401 (316) thicknesses 0.7mm to 3mm.

Plate & Sheet Cutting

Aalco, together with sister companies and approved sub-contractors, provides a full range of cutting services including guillotine, water-jet, laser and plasma as well as coil processing.

Treadplate

Stainless Treadplate, dual certified to DIN59220 (T) & ASTM A793 Pattern 1.

Coil, Strip & Blanks

Using sister companies and approved sub-contractors Aalco provides full range of coil processing services.

Polishing

Aalco stocks a range of polished & protectively-coated sheet in grades 1.4016 (430), 1.4301 (304) & 1.4401 (316).
 As well as this stock Aalco provides the full range of polished finishes and coatings on sheet and plate using sister companies and approved sub-contractors.



Full detail of all product ranges, alloys and sizes can be found in the Aalco Stocklist available **FREE** from your local Service Centre as well as on the website.

The superceded BS 1449 & BS 1501 standards have been replaced by BS EN Standards:

Standard	Scope
BS EN 10088-2	Replaces BS 1449-Part 2: 1983
BS EN 10028-7	Replaces BS 1501-Part 3: 1990
BS EN 10095	Covers Heat Resisting Grades
BS EN 10029	Tolerances for Quarto Hot Rolled Plate
BS EN 10051	Tolerances for Coil Produced (CPP) Hot Rolled Plate

It is useful to highlight where the new BS EN standards differ from the superceded BS standards:

- Mechanical Properties have been changed
- Tensile strengths are now higher and a maximum is stipulated
- Chemical Compositions vary slightly with Nickel contents on some grades being slightly lower
- 304S15, 304S16 & 304S31 have all been replaced by 1.4301
- BS EN 10088-2 states that Class B thickness tolerances shall normally be produced
- BS EN 10028-7 states that the normal thickness tolerance is Class B
- Surface Finish Standards have been extended and some changed

Flatness – Quarto Plate

Thickness (mm)	Tolerance in mm over given length in mm	
	1000	2000
≥ 3 to < 5	9	14
≥ 5 to < 8	8	12
≥ 8 to < 15	7	11
≥ 15 to < 25	7	10
≥ 25 to < 40	6	9
≥ 40 to ≤ 250	5	8

Flatness – CPP

Width	Tolerance* for given category		
	B	C	D**
Up to 1200	18	23	**
> 1200 to 1500	23	30	**
Over 1500	28	38	**

For CPP there are 3 categories of tolerances according to the grade where:

- B = Ferritic & Martensitic Grades
- C = Austenitic Grades without Mo
- D = Austenitic Grades with Mo

*These flatness tolerances only apply for thicknesses up to 25mm

**To be agreed at time of enquiry & order

Length – Quarto Plate

Length (mm)	Tolerance in mm	
Under 4000	- 0	+ 20
4000 to 5999	- 0	+ 30
6000 to 7999	- 0	+ 40

Length – CPP

Length (mm)	Tolerance in mm	
Under 2000	- 0	+ 10
≥ 2000 to < 8000	- 0	0.005 x Length

Width – Quarto Plate

Length (mm)	Tolerance in mm	
≥ 2000 to < 3000	- 0	+ 25
> 3000	- 0	+ 30

Width – CPP

Length	Plus tolerance in mm (- 0)	
	Mill edges	Trimmed
≤1200	+ 20	+ 3
> 1200 to ≤ 1500	+ 20	+ 5
Over 1500	+ 20	+ 6

Thickness – Quarto Plate to BS EN 10029 Class B

Thickness (mm)	Tolerance in mm		Max variation in mm within a plate for given width in mm	
	Minus	Plus	1000/1250/1500	2000
3 to 4.9	0.3	0.9	0.8	0.9
5 to 7.9	0.3	1.2	0.9	0.9
8 to 14.9	0.3	1.4	0.9	1.0
15 to 24.9	0.3	1.6	1.0	1.1
25 to 39.9	0.3	1.9	1.1	1.2
40 to 79.9	0.3	2.5	1.2	1.3
80 to 149	0.3	2.9	1.3	1.4
150 to 250	0.3	3.3	1.4	1.5

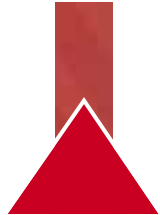

Thickness – CPP to BS EN 10051 Category A Materials*

Thickness (mm)	Tolerance in mm (plus or minus) for given width in mm			
	Up to 1200	1201 to 1500	1501 to 1800	Over 1800
Up to 2.0	0.17	0.19	0.21	-
> 2 to ≤ 2.50	0.18	0.21	0.23	0.25
> 2.5 to ≤ 3.0	0.20	0.22	0.24	0.26
> 3 to ≤ 4.0	0.22	0.24	0.26	0.27
> 4 to ≤ 5.0	0.24	0.26	0.28	0.29
> 5 to ≤ 6.0	0.26	0.28	0.29	0.31
> 6 to ≤ 8.0	0.29	0.30	0.31	0.35
> 8 to ≤ 10.0	0.32	0.33	0.34	0.40
> 10 to ≤ 12.50	0.35	0.36	0.37	0.43
> 12.5 to ≤ 15.0	0.37	0.38	0.40	0.46
> 15 to ≤ 25.0	0.40	0.42	0.45	0.50

Duplex grade thickness tolerances are not covered in BS EN 10051

* Category A Materials covers Ferritic and Martensitic Grades only. For non-Mo austenitics add 30% and for Mo austenitics add 40%.

Comparative Grades

AUSTENITIC				FERRITIC/MARTENSITIC	
BS 1449-2	BS EN 10088-2	BS 1449-2	BS EN 10088-2	BS 1449-2	BS EN 10088-2
284S16	-	316S13	1.4432	403S17	1.4000
301S21	1.4310	316S31	1.4401	405S17	1.4002
304S11	1.4307	316S33	1.4436	409S19	1.4512
304S15	1.4301	317S12	1.4438	430S17	1.4016
304S16	1.4301	317S16	-	434S17	1.4113
304S31	1.4301	320S31	1.4571	410S21	1.4006
305S19	1.4303	320S33	-	420S45	1.4028
315S16	-	321S31	1.4541		
316S11	1.4404	347S31	1.4550		

N.B. The grades stated are the nearest comparisons and not direct equivalents.

Main Grade Differences

Grade	Carbon (%)		Chrome (%)		Nickel (%)		UTS (N/mm ²)	
	Min.	Max.	Min.	Max.	Min.	Max.	Min.	Max.
304S15	-	0.06	17.5	19.0	8.0	11.0	500	-
304S16	-	0.06	17.5	19.0	9.0	11.0	500	-
304S31	-	0.07	17.0	19.0	8.0	11.0	490	690
1.4301	-	0.07	17.0	19.5	8.0	10.5	540*	750*
304S11	-	0.03	17.0	19.0	9.0	12.0	480	-
1.4307	-	0.03	17.5	19.5	8.0	10.0	520*	670*
316S31	-	0.07	16.5	18.5	10.5	13.5	510	-
1.4401	-	0.07	16.5	18.5	10.0	13.0	530*	680*
316S11	-	0.03	16.5	18.5	11.0	14.0	490	-
1.4404	-	0.03	16.5	18.5	10.0	13.0	530*	680*

* Tensile properties stated apply to steels in the solution annealed condition.

Finishes according to BS EN 10088-2/10028-7: See page 16

The superceded BS 1449 standard has been replaced by two BS EN Standards:

Standard	Scope
BS EN 10088-2	Replaces BS 1449-Part 2: 1983
BS EN 10059	Cover Heat Resisting Grades
BS EN 10259	Tolerances for Cold Rolled material

It is useful to highlight where the new BS EN standards differ from the superceded BS standards:

- 27 grades in BS have been replaced by 83 grades in EN and thus many EN grades do not have an old BS equivalent
- Mechanical Properties have been changed
- Tensile strengths are now higher and a maximum is stipulated
- Chemical Compositions vary slightly with Nickel contents on some grades being slightly lower
- 304S15, 304S16 & 304S31 have all been replaced by 1.4301
- Surface Finish Standards have been extended and some changed



Flatness Tolerances

Nominal Length (L) (mm)	Normal Tolerance (mm)
Up to 3000	10
Over 3000	12

Length Tolerances

Nominal Length (L) (mm)	Normal Tolerance (mm)
Up to 2000	+5 / -0
Over 2000	+0.0025 X L / -0

Thickness Tolerances

Thickness	Tolerance in mm (+ or -) for given width in mm		
	1000	1250	1500
Under 0.30	0.03	-	-
≥ 0.30 to < 0.50	0.04	0.04	-
≥ 0.50 to < 0.60	0.045	0.05	-
≥ 0.60 to < 0.80	0.05	0.05	-
≥ 0.80 to < 1.00	0.055	0.06	0.06
≥ 1.00 to < 1.20	0.06	0.07	0.07
≥ 1.20 to < 1.50	0.07	0.08	0.08
≥ 1.50 to < 2.00	0.08	0.09	0.10
≥ 2.00 to < 2.50	0.09	0.10	0.11
≥ 2.50 to < 3.00	0.11	0.12	0.12
≥ 3.00 to < 4.00	0.13	0.14	0.14

Width Tolerances

Thickness	All Plus Tolerance in mm for given width in mm (i.e. – 0)	
	1000	1250 & 1500
Under 1.5	+ 1.5	+ 2.0
≥ 1.50 to < 2.50	+ 2.0	+ 2.5
≥ 2.50 to < 3.50	+ 3.0	+ 3.0
≥ 3.50 to ≤ 6.50	+ 4.0	+ 4.0

Comparative Grades

AUSTENITIC				FERRITIC/MARTENSITIC	
BS 1449-2	BS EN 10088-2	BS 1449-2	BS EN 10088-2	BS 1449-2	BS EN 10088-2
284S16	-	316S13	1.4432	403S17	1.4000
301S21	1.4310	316S31	1.4401	405S17	1.4002
304S11	1.4307	316S33	1.4436	409S19	1.4512
304S15	1.4301	317S12	1.4438	430S17	1.4016
304S16	1.4301	317S16	-	434S17	1.4113
304S31	1.4301	320S31	1.4571	410S21	1.4006
305S19	1.4303	320S33	-	420S45	1.4028
315S16	-	321S31	1.4541		
316S11	1.4404	347S31	1.4550		

N.B. The grades stated are the nearest comparisons and not direct equivalents.

Main Grade Differences



Grade	Carbon (%)		Chrome (%)		Nickel (%)		UTS (N/mm ₂)	
	Min.	Max.	Min.	Max.	Min.	Max.	Min.	Max.
304S15	-	0.06	17.5	19.0	8.0	11.0	500	-
304S16	-	0.06	17.5	19.0	9.0	11.0	500	-
304S31	-	0.07	17.0	19.0	8.0	11.0	490	690
1.4301	-	0.07	17.0	19.5	8.0	10.5	540*	750*
304S11	-	0.03	17.0	19.0	9.0	12.0	480	-
1.4307	-	0.03	17.5	19.5	8.0	10.0	520*	670*
316S31	-	0.07	16.5	18.5	10.5	13.5	510	-
1.4401	-	0.07	16.5	18.5	10.0	13.0	530*	680*
316S11	-	0.03	16.5	18.5	11.0	14.0	490	-
1.4404	-	0.03	16.5	18.5	10.0	13.0	530*	680*

* Tensile properties stated apply to steels in the solution annealed condition.

For more information on these or any Aalco products please visit:

www.aalco.co.uk

The Core Product Ranges are:

<p>Round Bar</p> <p>1.4305 (303) Bright Drawn in metric and imperial diameters from 3mm & 1/8" to 25mm & 1" Smooth Turned or Bright Ground in metric and imperial diameters from 25mm & 1" to 60mm & 3" Rough Turned in imperial diameters from 3" to 7"</p> <p>1.4301 (304) Bright Drawn in metric and imperial diameters from 3mm & 1/8" to 25mm & 1" Smooth Turned in metric and imperial diameters from 25mm & 1" to 60mm & 3" Rough Turned in imperial diameters from 3" to 16"</p> <p>1.4404 (316) Bright Drawn in metric and imperial diameters from 3mm & 1/8" to 25mm & 1" Smooth Turned or Bright Ground in metric and imperial diameters from 7/8" & 25mm to 60mm & 3" Rough Turned in imperial diameters from 3" to 16"</p>	
	<p>Flat Bar Metric sizes from 20mm x 10mm to 100mm x 25mm in grades 1.4307 (304) & 1.4404 (316L)</p> <p>Rolled Edge Flat Bar From 12mm x 3mm to 100 x 12mm in grades 1.4301 (304) & 1.4404 (316L) Non-standard widths and other grades available to order on short lead time</p>
<p>Hexagon Bar From 0.3125" to 2.5" in grades 1.4305 (303) & 1.4404 (316L)</p>	
<p>Square Bar Metric sizes from 12mm x 12mm to 50mm x 50mm in grades 1.4301 (304) & 1.4404 (316L)</p>	
<p>Angle Metric sizes from 20 x 20 x 3mm to 100 x 100 x 10mm in grades 1.4301 (304) & 1.4404 (316L) Other sizes can be fabricated on short lead times</p>	
<p>Bar Sawing Aalco Service Centres have bar sawing capacity on-site to provide anything from single cut lengths to high volume repetition cuts</p>	

Full detail of all product ranges, alloys and sizes can be found in the Aalco Stocklist available **FREE** from your local Service Centre as well as on the website.



The superceded BS 970 Parts 1 & 3: 1991 standards have been replaced by a number of BS EN Standards, the most important of which are shown below.

Standard	Scope
BS EN 10088-3	Replaces BS 970 Part 1: 1991 & BS 970 Part 3: 1991 covering chemical composition & mechanical properties
BS EN 10058	Tolerances for Hot Rolled Flat Bars
BS EN 10059	Tolerances for Hot Rolled Square Bars
BS EN 10060	Tolerances for Hot Rolled Round Bars
BS EN 10061	Tolerances for Hot Rolled Hexagonal Bars
BS EN 10278	Tolerances for Bright Bars (Drawn, Turned or Ground)
ISO 286-2	Tolerance Classifications (see page 4)

Diameter Tolerances – Smooth Turned

Diameter (mm)	Tolerance (mm)
> 18 to ≤ 30	+ 0 / - 0.084
> 30 to < 50	+ 0 / - 0.100
> 50 to < 80	+ 0 / - 0.120

Diameter Tolerances – Bright Drawn

Diameter (mm)	Tolerance (mm)
> 6 to ≤ 10	+ 0 / - 0.036
> 10 to ≤ 18	+ 0 / - 0.043
> 18 to ≤ 30	+ 0 / - 0.052

Diameter Tolerances – Rough Turned

Diameter (mm)	Tolerance (mm)
75 to 150	- 0 / +1.5
151 to 225	- 0 / +2.0
226 to 410	- 0 / +3.0

Thickness Tolerances – Hot Rolled Flat

Size (mm)	Tolerance (mm)
Up to 20	+ / - 0.5
20 to 40	+ / - 1.0
> 40 to 80	+ / - 1.5

Width Tolerances – Hot Rolled Flat

Size (mm)	Tolerance (mm)
10 to 40	+ / - 0.75
> 40 to 80	+ / - 1.0
> 80 to 100	+ / - 1.5
> 100 to 120	+ / - 2.0
> 120 to 150	+ / - 2.5

Tolerances – Rolled Edge Flat Bars

Width	+ / - 1.0mm
Thickness	+ / - 0.5 mm
Flatness across width	1mm Max Variation
Flatness across length	12-40mm: 25mm Max Variation 41-100mm: 20mm Max Variation
Edge Bow	12-40mm: 15mm Max Variation 41-100mm: 10mm Max Variation

Tolerances – Hot Rolled Square Bars

Diameter (mm)	Tolerance (mm)
75 to 150	- 0 / + 1.5
151 to 225	- 0 / + 2.0
226 to 410	- 0 / + 3.0

Tolerances – Angle Bars

Leg Size	Leg Tolerance	Thickness Tolerance	Max Internal Radius
	+ / - mm	+ / - mm	mm
20 x 20	1.5	0.4	4
25 x 25	1.5	0.5	4
30 x 30	2.0	0.5	4
40 x 40	2.0	0.6	5
50 x 50	2.0	0.6	7
60 x 60	3.0	0.75	7
65 x 65	3.0	0.75	9
70 x 70	3.0	0.75	9
75 x 75	3.0	0.75	9
80 x 80	3.0	0.75	9
90 x 90	3.0	0.75	10
100 x 100	3.0	0.75	10

Comparative Grades

AUSTENITIC				FERRITIC/MARTENSITIC	
BS 970	BS EN 10088-3	BS 970	BS EN 10088-3	BS 970	BS EN 10088-3
303S31	1.4305	321S31	1.4541	410S21	1.4006
304S11	1.4307	316S11	1.4404	416S21	1.4005
304S15/S31	1.4301	316S31	1.4401	431S29	1.4057

N.B. The grades stated are the nearest comparisons and not direct equivalents.

Main Grade Differences

Grade	Carbon (%)		Chrome (%)		Nickel (%)		UTS (N/mm ₂)	
	Min.	Max.	Min.	Max.	Min.	Max.	Min.	Max.
303S31	-	0.12	17.0	19.0	8.0	10.0	510	-
1.4305	-	0.10	17.0	19.0	8.0	10.0	500*	750*
304S31	-	0.07	17.0	19.0	8.0	11.0	490	-
1.4301	-	0.07	17.0	19.5	8.0	10.5	500*	700*
304S11	-	0.03	17.0	19.0	9.0	12.0	480	-
1.4307	-	0.03	17.5	19.5	8.0	10.0	500*	700*
316S31	-	0.07	16.5	18.5	10.5	13.5	510	-
1.4401	-	0.07	16.5	18.5	10.0	13.0	500*	700*
316S11	-	0.03	16.5	18.5	11.0	14.0	490	-
1.4404	-	0.03	16.5	18.5	10.0	13.0	500*	700*

* Tensile properties stated apply to steels in the solution annealed condition.

ISO 286 Tolerances in mm

Diameters (mm)	Tolerance in mm for given Tolerance Number							
	6	7	8	9	10	11	12	13
> 1 – 3 inc.	0.007	0.009	0.014	0.025	0.040	0.060	0.090	0.140
> 3 – 6 inc.	0.008	0.012	0.018	0.030	0.048	0.075	0.120	0.180
> 6 – 10 inc.	0.009	0.015	0.022	0.036	0.058	0.090	0.150	0.220
> 10 – 18 inc.	0.011	0.018	0.027	0.043	0.070	0.110	0.180	0.270
> 18 – 30 inc.	0.013	0.021	0.033	0.052	0.084	0.130	0.210	0.330
> 30 – 50 inc.	0.016	0.025	0.039	0.062	0.100	0.160	0.250	0.390
> 50 – 80 inc.	0.019		0.046	0.074	0.120	0.190	0.300	0.460
> 80 – 120 inc.	0.022			0.087	0.140	0.220	0.350	0.540
> 120 – 180 inc.	0.025			0.100	0.160	0.250	0.400	0.630
> 180 – 250 inc.				0.115	0.185	0.290	0.460	0.720
> 250 – 315 inc.						0.320	0.520	0.810
> 315 – 400 inc.						0.360	0.570	0.890
> 400 – 500 inc..						0.400	0.630	0.970
> 500						0.440	0.700	1.100

EXAMPLES:

H	=	Minus tolerance	e.g. 45 mm dia H9	=	+ 0 / - 0.062
J	=	Tolerance divided	e.g. 45 mm dia J9	=	+ / - 0.031
K	=	Plus tolerance	e.g. 45 mm dia K9	=	+ 0.062 / - 0

The Core Product Ranges are:

Tube

Seamless to ASTM A269, imperial sizes from 1/8" O/D x 24swg to 4" O/D x 1/4" wall in grade 316L

Seamless to ASTM A269, grades 304L & 316L, in metric sizes 6mm O/D x 0.5mm wall to 38mm O/D x 4mm wall

Decorative – Round, Square, Rectangular

Structural – Square and Rectangular up to 250mm

Hygienic – See below

Welded Metric Nominal Internal Diameter - See below



Pipe

Seamless and welded to ASTM A312 from 1/4" to 12" in grades 304L & 316L

Flanges

ASTM A182 / ANSI B16.5

BS 10 Table E, Grade 316L

BS 4504 / EN 1092 Raised Face, 16 Bar

Backing Flanges in Aluminium and Coated Mild Steel



Fittings

Butt Weld Fittings, Seamless and Welded, to ASTM A403 in grades 304L & 316L including elbows, tees & reducers

BSP Screwed Fittings, grade 316 from 1/8" to 3"

Hygienic fittings (see below)

Welded Metric Nominal Internal Diameter (see below)

Hygienic Tube and Fittings

Grades 304L & 316L 3/4" O/D to 4" O/D:

Tube – As welded & Descaled, Annealed & polished or Bright Annealed
Bends, Fitted Bends, Tees, Reducers, Clamps & Tube Hangers

Unions – RJT, IDF & DIN



Metric – Welded Nominal Internal Diameter (ND)

From 18mm O/D x 1.5mm wall to 910mm O/D x 5mm wall
Grades 1.4432 (316L High Molybdenum), 1.4307 (304L) & 1.4571 (316 Ti)

Tube, Elbows, Tees, Reducers, Collars, End Caps, Tube Clamps & Clips

Backing Flanges in Aluminium & Coated Mild Steel

Full detail of this range is available in a separate publication as well as on the web site

Aalco Stainless Steel Tube Databook & CD-ROM

Aalco has produced a 400 page guide to tubular product specifications for stainless steel. It is available on CD-ROM and can be down-loaded from the web site



Full detail of all product ranges, alloys and sizes can be found in the Aalco Stocklist available **FREE** from your local Service Centre as well as on the website. The Aalco Tubular Products Data-Book provides a comprehensive 400-page guide to this extensive product range including all relevant specifications – This is available online or from your local Service Centre on CD-ROM.

The term pipe covers a specific range of sizes laid down by ANSI specifications. Any sizes not covered by these specifications are tube. Stainless Steel Pipe dimensions determined by ASME B36.19 covering the outside diameter and the Schedule wall thickness. Note that stainless wall thicknesses to ANSI B36.19 all have an 'S' suffix. Sizes without an 'S' suffix are to ANSI B36.10 which is intended for carbon steel pipes.



Welded Pipe Specifications

Usually it will be to ASTM A312. If it is to ASTM A358 then there are various Classes available as shown below. The Class Number dictates how the pipe is welded and what non-destructive tests:

- **Class 1:** Pipe shall be double welded by processes employing filler metal in all passes and shall be completely radiographed.
- **Class 2:** Pipe shall be double welded by processes employing filler metal in all passes. No radiography is required.
- **Class 3:** Pipe shall be welded in one pass by processes employing filler metal and shall be completely radiographed.
- **Class 4:** Same as Class 3 except that the welding process exposed to the inside pipe surface may be made without the addition of filler metal.
- **Class 5:** Pipe shall be double welded by processes employing filler metal in all passes and shall be spot radiographed.

Markings on pipe

The full identification of the pipe should be continuously marked down its whole length, including:

- Nominal Pipe Size (Nominal Bore)
- Schedule (Wall Thickness)
- Specification
- Grade
- Method of Manufacture (Seamless or Welded)
- Heat Number
- Manufacturer's Name or Symbol

Seamless and Welded

ASTM A312: Seamless and straight-seam welded austenitic pipe intended for high temperature and general corrosive service. Filler metal not permitted during welding.

ASTM A358: Electric fusion welded austenitic pipe for corrosive and/or high temperature service. Typically only pipe up to 8 inch is produced to this specification. Addition of filler metal is permitted during welding.

ASTM A790: Seamless and straight-seam welded ferritic/austenitic (duplex) pipe intended for general corrosive service, with a particular emphasis on resistance to stress corrosion cracking.

ASTM A409: Straight-seam or spiral-seam electric fusion welded large diameter austenitic light-wall pipe in sizes 14" to 30" with walls Sch5S and Sch 10S for corrosive and/or high temperature service.

ASTM A376: Seamless austenitic pipe for high temperature applications.

ASTM A813: Single-seam, single- or double- welded austenitic pipe for high temperature and general corrosive applications.





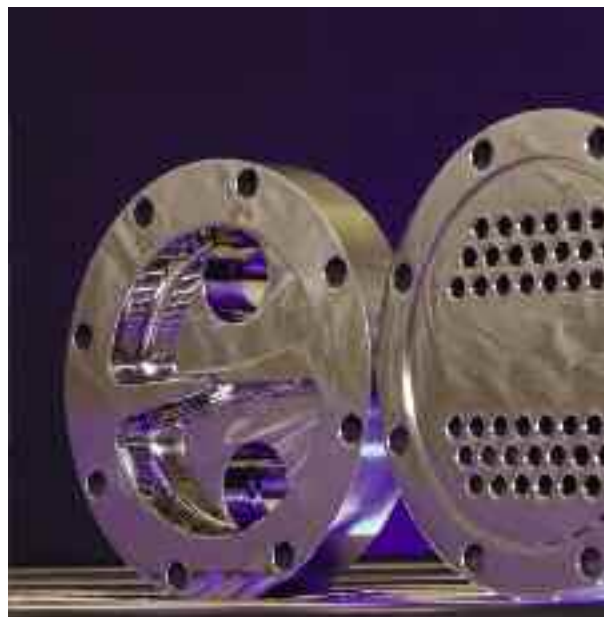



ASTM A814: Cold-worked welded austenitic pipe for high temperature and general corrosive service.

Note: Welded pipes manufactured to ASTM A312, A790 and A813 must be produced by an automatic process with NO addition of filler metal during the welding operation.



Pipe Sizes

Pipe dimensions and weights per metre ANSI/ASME B36.19M-1985

Nominal Pipe Size	OD		Schedule 5S ¹			Schedule 10S ¹			Schedule 40S			Schedule 80S		
														
	in	mm	in	mm	kg/m	in	mm	kg/m	in	mm	kg/m	in	mm	kg/m
1/8	0.405	10.3	–	–	–	0.049	1.24	0.28	0.068	1.73	0.37	0.095	2.41	0.47
1/4	0.540	13.7	–	–	–	0.065	1.65	0.49	0.088	2.24	0.63	0.119	3.02	0.80
3/8	0.675	17.1	–	–	–	0.065	1.65	0.63	0.091	2.31	0.84	0.126	3.20	1.10
1/2	0.840	21.3	0.065	1.65	0.80	0.083	2.11	1.00	0.109	2.77	1.27	0.147	3.73	1.62
3/4	1.050	26.7	0.065	1.65	1.03	0.083	2.11	1.28	0.113	2.87	1.69	0.154	3.91	2.20
1	1.315	33.4	0.065	1.65	1.30	0.109	2.77	2.09	0.133	3.38	2.50	0.179	4.55	3.24
1 1/4	1.660	42.2	0.065	1.65	1.65	0.109	2.77	2.70	0.140	3.56	3.39	0.191	4.85	4.47
1 1/2	1.900	48.3	0.065	1.65	1.91	0.109	2.77	3.11	0.145	3.68	4.05	0.200	5.08	5.41
2	2.375	60.3	0.065	1.65	2.40	0.109	2.77	3.93	0.154	3.91	5.44	0.218	5.54	7.48
2 1/2	2.875	73.0	0.083	2.11	3.69	0.120	3.05	5.26	0.203	5.16	8.63	0.276	7.01	11.41
3	3.500	88.9	0.083	2.11	4.51	0.120	3.05	6.45	0.216	5.49	11.29	0.300	7.62	15.27
3 1/2	4.000	101.6	0.083	2.11	5.18	0.120	3.05	7.40	0.226	5.74	13.57	0.318	8.08	18.63
4	4.500	114.3	0.083	2.11	5.84	0.120	3.05	8.36	0.237	6.02	16.07	0.337	8.56	22.32
5	5.563	141.3	0.109	2.77	9.47	0.134	3.40	11.57	0.258	6.55	21.77	0.375	9.53	30.97
6	6.625	168.3	0.109	2.77	11.32	0.134	3.40	13.84	0.280	7.11	28.26	0.432	10.97	42.56
8	8.625	219.1	0.109	2.77	14.79	0.148	3.76	19.96	0.322	8.18	42.55	0.500	12.70	64.64
10	10.750	273.1	0.134	3.40	22.63	0.165	4.19	27.78	0.365	9.27	60.31	0.500 ²	12.70 ²	96.01 ²
12	12.750	323.9	0.156	3.96	31.25	0.180	4.57	36.00	0.375 ²	9.53 ²	73.88 ²	0.500 ²	12.70 ²	132.08 ²
14	14.000	355.6	0.156	3.96	34.36	0.188 ²	4.78 ²	41.30 ²	–	–	–	–	–	–
16	16.000	406.4	0.165	4.19	41.56	0.188 ²	4.78 ²	47.29 ²	–	–	–	–	–	–
18	18.000	457	0.165	4.19	46.81	0.188 ²	4.78 ²	53.26 ²	–	–	–	–	–	–
20	20.000	508	0.188	4.78	59.25	0.218 ²	5.54 ²	68.61 ²	–	–	–	–	–	–
22	22.000	559	0.188	4.78	65.24	0.218 ²	5.54 ²	75.53 ²	–	–	–	–	–	–
24	24.000	610	0.218	5.54	82.47	0.250	6.35	94.45	–	–	–	–	–	–
30	30.000	762	0.250	6.35	118.31	0.312	7.92	147.36	–	–	–	–	–	–

Notes

- Schedules 5S and 10S wall thicknesses do not permit threading in accordance with ANSI/ASME B1.20.1.
- These dimensions and weights do not conform to ANSI/ASME B36.10M.
 - The suffix 'S' after the schedule number indicates that the pipe dimensions and weight are in compliance with this stainless steel pipe specification, ANSI/ASME B36.19M-1985, and not the more general ANSI/ASME B36.10M-1995 specification.
 - Although this specification is applicable to stainless steel, quoted weights are for carbon steel pipe and should be multiplied by 1.014 for austenitic and duplex steels, or by 0.985 for ferritic and martensitic steels.

Tube Specifications

ASTM Standards covered in this section	
ASTM Tube – General Requirements	
A450/A450M	General Requirements for Carbon, Ferritic Alloy, and Austenitic Alloy Steel Tubes (Incorporated within the ASTM Tube General Requirements subsection)
A370	Mechanical Testing of Steel Products, (Incorporated within the ASTM Tube General Requirements subsection)
A213/A213M	Seamless Ferritic and Austenitic Alloy-Steel Boiler, Superheater and Heat Exchanger and Condenser Tubes
A249/A249M	Welded Austenitic Steel Boiler, Superheater, Heat Exchanger and Condenser Tubes
A268/A268M	Seamless and Welded Ferritic and Martensitic Stainless Steel Tubing for General Service
A269	Seamless and Welded Austenitic Stainless Steel Tubing for General Service
A270	Seamless and Welded Austenitic Stainless Steel Sanitary Tubing
A511	Seamless Stainless Steel Mechanical Tubing
A554	Welded Stainless Steel Mechanical Tubing
A632	Welded, Unannealed Austenitic Stainless Steel Tubular Products
A778	Welded, Unannealed Austenitic Stainless Steel Tubular Products
A789/A789M	Seamless and Welded Ferritic/Austenitic (Duplex) Stainless Steel Tubing for General Service
A791/A791M	Welded, Unannealed Ferritic Stainless Steel Tubing
A803/A803M	Welded Ferritic Stainless Steel Feedwater Heater Tubes

Grades Available

Types 304L and 316L are the most readily available from stock in a large range of metric and imperial tube sizes and wall thicknesses. A wide range of other sizes and grades including duplex types and nickel alloys are manufactured to order.



Markings on the tube

The full identification should be continuously marked down the whole length, including:

- Size – Outside Diameter (O/D) and Wall Thickness
- Specification
- Grade
- Method of Manufacture (Seamless or Welded)
- Heat Number
- Manufacturer's Name or Symbol

Tube Size Ranges

An extensive size range is available. Non-standard tube sizes may be subject to mill quantity restrictions and extended delivery times.

Below is a guide to the sizes readily available on an ex-stock basis:

- Hypodermic tube from 0.4mm to 5mm O/D with wall thickness 0.05mm to 0.4mm
- Instrumentation tube in straight lengths or continuous coils of up to 1,000 metres long: O/Ds 6mm, 8mm, 10mm and 12mm with heavy wall thicknesses, typically 0.5mm, 1mm, 1.5mm or 2mm
- Metric sizes from 6mm O/D to 610mm O/D with wall thickness 1mm to 6mm
- Imperial sizes from 1/8" O/D to 6" O/D with wall thickness from 24swg to 10swg
- Hygienic/Sanitary Tube
 - Imperial sizes to ASTM A270: 1/2", 1", 1 1/2", 2", 2 1/2", 3" & 4" O/D with 16swg wall and 4" O/D with 14swg wall
 - Metric sizes to DIN 11850: 1", 1 1/2", 2", 2 1/2" & 3" O/D with 1.5mm wall and 4" O/D with 2mm wall
- Welded Tubes for the water industry from 18mm O/D x 1.5mm wall to 910mm O/D x 5mm wall
- Welded Tube for automotive exhaust systems, mostly in grade 409 – A limited size range from 35 to 63mm O/D with wall thickness 1.2mm to 2mm
- Decorative and structural tubes (welded)
 - Round in metric and imperial O/D sizes from 6mm O/D x 1.0mm wall to 100mm O/D x 3mm wall and 1/8" O/D x 24swg to 4" O/D x 1/4" wall
 - Square in metric and imperial O/D sizes from 12.7mm O/D x 1.5mm wall to 250mm x 250 x 10mm wall
 - Rectangular in metric sizes from 20mm x 10mm x 1.2mm wall to 300mm x 200 x 10mm wall
 - Other items include Oval, Handrail and Textured Finish – Most common oval size is 60mm x 33mm x 2.0mm wall
 - Note that most decorative tubes are supplied with a polished finish

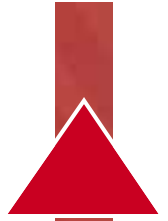

Tube

Standard Tolerances for welded and seamless cold finished tube (ASTM A 450/A 450M)

(OD)		Variations in OD ¹				Variation in t_{min} ²		(Thin wall tube only)	
		Under		Over		Under	Over		
in	mm	in	mm	in	mm	%	%	in	m
< 1	< 25.4	0.004	0.1	0.004	0.1	0	20	0.020	0.5
1	25.4	0.006	0.15	0.006	0.1	0	20	0.020 ⁴	0.5 ⁴
>1 to 1½	>25.4 to 38.1	0.006	0.15	0.006	0.15	0	20	0.020 ⁴	0.5 ⁴
>1½ to < 2	>38.1 to < 50.8	0.008	0.2	0.008	0.2	0	22	0.020 ⁴	0.5 ⁴
2	50.8	0.008	0.2	0.008	0.2	0	22	2.0% of OD	
>2 to 2½	>50.8 to 63.5	0.010	0.25	0.010	0.25	0	22	2.0% of OD	
>2½ to 3	>63.5 to 76.2	0.012	0.3	0.012	0.3	0	22	2.0% of OD	
>3 to 4	>76.2 to 101.6	0.015	0.38	0.015	0.38	0	22	2.0% of OD	

Notes

- Includes ovality tolerance except for thin wall tube
- t_{min} = minimum wall thickness
- Ovality = Difference between maximum and minimum OD
Thin wall tube is defined as that with a wall thickness $t \leq 0.020$ in (0.5 mm) for any OD, or $t \leq 2\%$ of OD if OD ≤ 2 in (50.8mm), or $t \leq 3\%$ of OD if OD > 2 in (50.8mm)
- Or 2.0% of OD, if this gives a larger tolerance value.

For more information plus a complete table of sizes and dimensions as well as full specifications, please visit the Down-Loads page of the Aalco web site and select the Tubular Products Databook. www.aalco.co.uk/literature

Hygienics

Stainless Steel Hygienics is the name given to a range of tube and fittings used in applications requiring a clean and sanitary flow of liquids and where it is essential to avoid contamination of the products being carried.

These applications cover the food processing, beverage, biotech and pharmaceutical industries including breweries and dairies.

- The applications are low pressure with a maximum of 150lbs.
- The products are available in grades 304L and 316L.
- The size range is from 1/2 inch to 4 inch O/D.
- The tube and fittings are of welded construction with the internal bead rolled to flatten it and eliminate crevices, thus preventing interruptions to the flow and eliminating the risk of contamination or bug traps as well as facilitate easy cleaning.
- The tube and fittings are offered with a choice of external finishes:
 - Descaled
 - Bright Annealed
 - Dull Polished
 - Semi-Bright or Bright Polished.

Manufacturing Standards

- Hygienic tubes are manufactured to ASTM A270, DIN 11850 and BS 4825 Part 1.
- Hygienic fittings are manufactured to BS 4825 Parts 2 to 5.

Markings on tube and fittings

Tube and fittings with a bright annealed or polished finish will be unmarked.

Size Range

Sizes to ASTM A270

O/D in	Wall swg/mm
1/2	16 /1.63
1	16 /1.63
1½	16 /1.63
2	16 /1.63
2½	16 /1.63
3	16 /1.63
4	16 /1.63
4	14 /2.03

Sizes to DIN 11850

O/D in	Wall mm
1	1.5
1½	1.5
2	1.5
2½	1.5
3	1.5
4	2.0

Bends – 45 and 90 degree bends & 180 degree return bends



Pulled Tees

Reducers – Concentric & Eccentric



Seals – Nitrile Rubber, EPDM



Full Tees

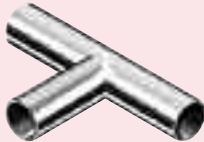

Pipe Clips and Hangers

Reducing Tees



RJT Union

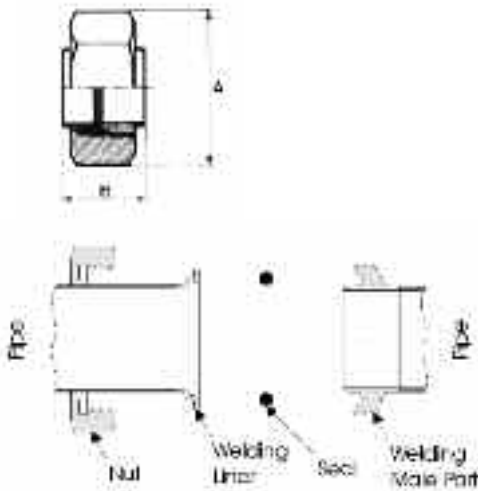

The Ring Joint Type (RJT) Union, manufactured to BS 4825 Part 5, comprises four parts: Nut - Liner - Seal - Male Part.

Primarily used where tubes are frequently disassembled for cleaning.

The seal is of an 'O Ring' type and is made of Nitrile:



IDF Union

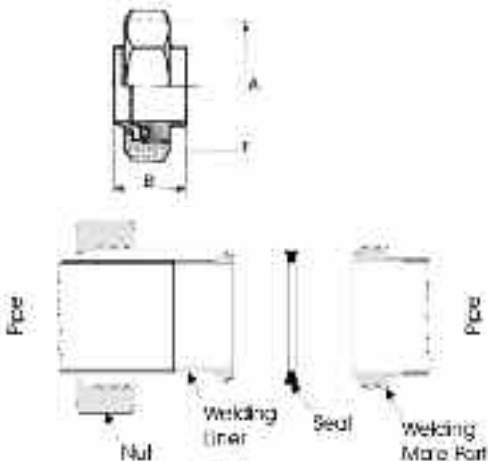

The International Dairy Federation (IDF) Union manufactured to ISO 2853 and BS 4825 Part 4, comprises four parts: Nut - Liner - Seal - Male Part. Here the liner is machined and the seal is a square section. It has a thicker nut than the RJT and a more substantial liner. It is machined rather than pressed. It is considered easier to use.

The IDF has a smoother and cleaner flow line that is free of crevices and bug traps. Its principle use is in CIP (Clean In Place) systems involving infrequent access and joint disassembly.

The IDF seal has a square section and is more substantial than the RJT. It is made of Nitrile or EPDM.



Butt Weld Fittings are a family of fittings used for forming circumferential butt weld joints in pipe-work systems.

They are used only in conjunction with ANSI Pipe and are available in the same size range.

They are used in areas where pipe-work is permanent and are designed to provide good flow characteristics.



Manufacturing Standards

Wrought pipe fittings are manufactured to dimensions and tolerances in ANSI B16.9 with the exception of short radius elbows and return bends which are made to ANSI B16.28. Light-weight corrosion resistant fittings are made to MSS SP43.

Butt Weld Fittings are available to ASTM A403, ASTM A815 and MSS SP43. These standards require the fittings to be manufactured as follows:

- Seamless austenitic fittings are made from seamless pipe to ASTM A312.
- Welded fittings in austenitic grades are manufactured from welded pipe to ASTM A312 or plate to ASTM A240. Note that welded fittings manufactured from plate may have two welds.
- Duplex (ferritic/austenitic) grades are manufactured from pipe to ASTM A790 or plate to ASTM A240.



ASTM A403/A815 Butt Weld Fittings are sub-divided into four classes:

- **WP-S:** Made from seamless pipe to ASTM A312 (Austenitic) or ASTM A790 (Duplex).
- **WP-W:** Manufactured from welded pipe to ASTM A312 (Austenitic) or ASTM A790 (Duplex). There is no requirement for radiography unless a manufacturer's weld has been introduced or there are welds made with the addition of filler metal.
- **WP-WX:** Of welded construction. All welds must be 100% radiographed in accordance with Paragraph UW-51 of Section VIII, Division 1 of the ASME Boiler and Pressure Vessel Code.
- **WP-WU:** Of welded construction. All welds must be 100% examined ultrasonically in accordance with Paragraph UW-51 of Section VIII, Division 1 of the ASME Boiler and Pressure Vessel Code. Note that this Class only applies to austenitic fittings made to ASTM A403.

CR Fittings are manufactured to the requirements of MSS SP43. These are light-weight fittings and do not require radiography.

Notes:











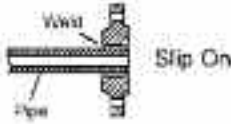

- WP: Means Wrought Pipe
- CR: Means Corrosion Resistant

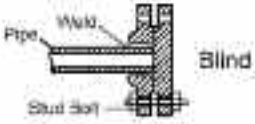

Markings on tube and fittings

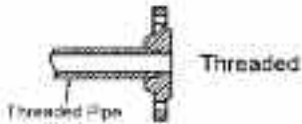
The full identification of the fitting should be marked on it including:

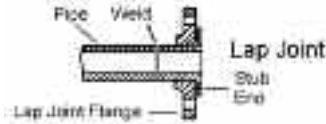
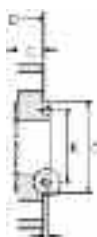
- Nominal Pipe Size (Nominal Bore)
- Schedule (Wall Thickness)
- Specification
- Grade
- Method of Manufacture (Seamless or Welded)
- Heat Number
- Manufacturer's Name or Symbol

Type	Joining Method	General Description
<p>Weld Neck</p> 	 <p>Weld Neck</p>	<p>Used in critical applications. These are circumferentially welded onto the system at their necks which means that the integrity of the butt-welded area can easily be examined by X-ray radiography. The bores of both pipe and flange match thus reducing turbulence and erosion.</p>
<p>Slip On</p> 	 <p>Slip On</p>	<p>This is slipped over the pipe and then fillet welded. Easy to use in fabricated applications.</p>
<p>Blind</p> 	 <p>Blind</p>	<p>Sometimes called a blanking flange, this is used for blanking off pipelines, valves and pumps and as an inspection cover.</p>
<p>Socket Weld</p> 	 <p>Socket Weld</p>	<p>This is counter-bored to accept the pipe, which is then fillet welded. The bore of both the pipe and the flange are the same to ensure good flows.</p>
<p>Screwed/Threaded</p> 	 <p>Threaded</p>	<p>This requires no welding and is used to connect other threaded components in low pressure non-critical applications.</p>
<p>Lap Joint</p> 	 <p>Lap Joint</p>	<p>These are always used with either a stub end or a taft which is butt-welded to the pipe with the flange loose behind it. Thus the stub end or the taft always provides the sealing face. Easily assembled and aligned, it is favoured in low pressure applications. To reduce cost these 'backing' flanges can be supplied without a hub and/or made from coated carbon steel.</p>
<p>Ring Type Joint</p> 	 <p>Ring Type Joint</p>	<p>This can be employed on Weld Neck, Slip On or Blind Flanges for leak-proof connection at high pressures. The seal is made by a metal ring being compressed into a hexagonal groove on the flange face.</p>

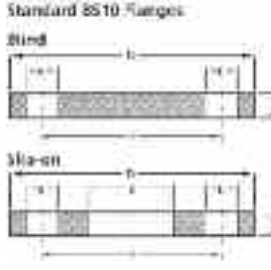

Type	General Description
Weld Neck Standard BS10 Flanges 	Plate or Table (BS 10:1962) These are produced to suit Nominal Bore/NPS Pipe Sizes. They are produced from bar or plate rather than forgings and are not pressure rated. Blind and Slip-On, flat-faced, types are readily available in grades 304L and 316L in sizes from 1/2" to 6" as Table D and Table E, with larger sizes and other Tables (thicknesses) made to order. These economical flanges are used for light-duty applications where corrosion resistance is the primary consideration rather than high pressure or temperature.
BS EN 1092 Part 1 Also referred to as PN Flanges (Formerly BS 4504)	These are not interchangeable with ANSI Flanges. They are available readily available in types 304L and 316L with various pressure ratings of which 10 Bar & 16 Bar are the most commonly used.
Metric Tru-Bore	Please visit the Down-Loads page of the Aalco web site www.aalco.co.uk/literature and select the brochure on this product range.
Hygienic	Please refer to information about the Hygienics product range on pages 40 & 41.

Flange Faces

Of the four choices available the most common configurations are:

- For ANSI and BS EN 1092 – Raised Face
- BS 10 – Flat Face.

Note that this does not apply to Screwed or Lap Joint Flanges.

Type	General Description
Raised Face	To facilitate welding
Flat Face	
Ring Type Joint (RTJ)	For leak-proof connection at high pressures
Tongue & Groove – Small or Large	

Finish

The finish is given as a surface roughness measured as Arithmetic Average Roundness Height (AARH). The finish requirements are stipulated by the standards, such as ANSI B16.5 and are within the range 125AARH to 500AARH, which is equivalent to 3.2 to 12.5 Ra.



Pressure Ratings

(The pressure rating will also determine the dimensions of the flange – Full details can be found in the relevant specification.)

Flange Type	ANSI B16.5	ANSI B16.47 Series A MSS SP-44	ASME B16.47 Series B API 605	BS EN 1092/ (BS 4504)
	lbs	lbs**	lbs**	Bar
Weld Neck	150-2500	150-900	150-300	2.5-40
Weld Neck Ring Type Joint	300-2500	300-900	150-300	N/A
Slip On	150-1500	-	-	2.5-40
Slip On Ring Type Joint	300-1500	-	-	N/A
Threaded	150-2500	-	-	6-40
Lap Joint	150-2500	-	-	6-40
Blind	150-2500	-	-	2.5-40
Socket Weld	150-1500	-	-	N/A

Note: **Flange sizes 26" and above

What semi-finished product are flanges made from?

	Forging A182	Plate ASTM A240	Bar	Casting
ANSI B16.5	✓	✓	-	-
BS 3293	✓	-	-	-
MSS SP-44	✓	-	-	-
API 605	✓	-	-	-
BS EN 1092/(BS 4504)	✓	✓	-	✓
BS 10	✓	✓	✓	✓

Notes:

- ASTM A240 plate can be used to manufacture ANSI B16.5 blind flanges, but this is not generally accepted in the UK.
- Most small BS 10 flanges are normally made from bar as this is the most economical manufacturing process.

Markings on a flange

All flanges should be permanently marked on the external diameter of the base with:

- Pipe Size (NPS/NB)
- Pipe Wall Thickness (Schedule) if appropriate
- Specification
- Grade
- Heat Number
- Manufacturer's Name or Symbol



Whitworth Threads/British Standard Pipe Thread

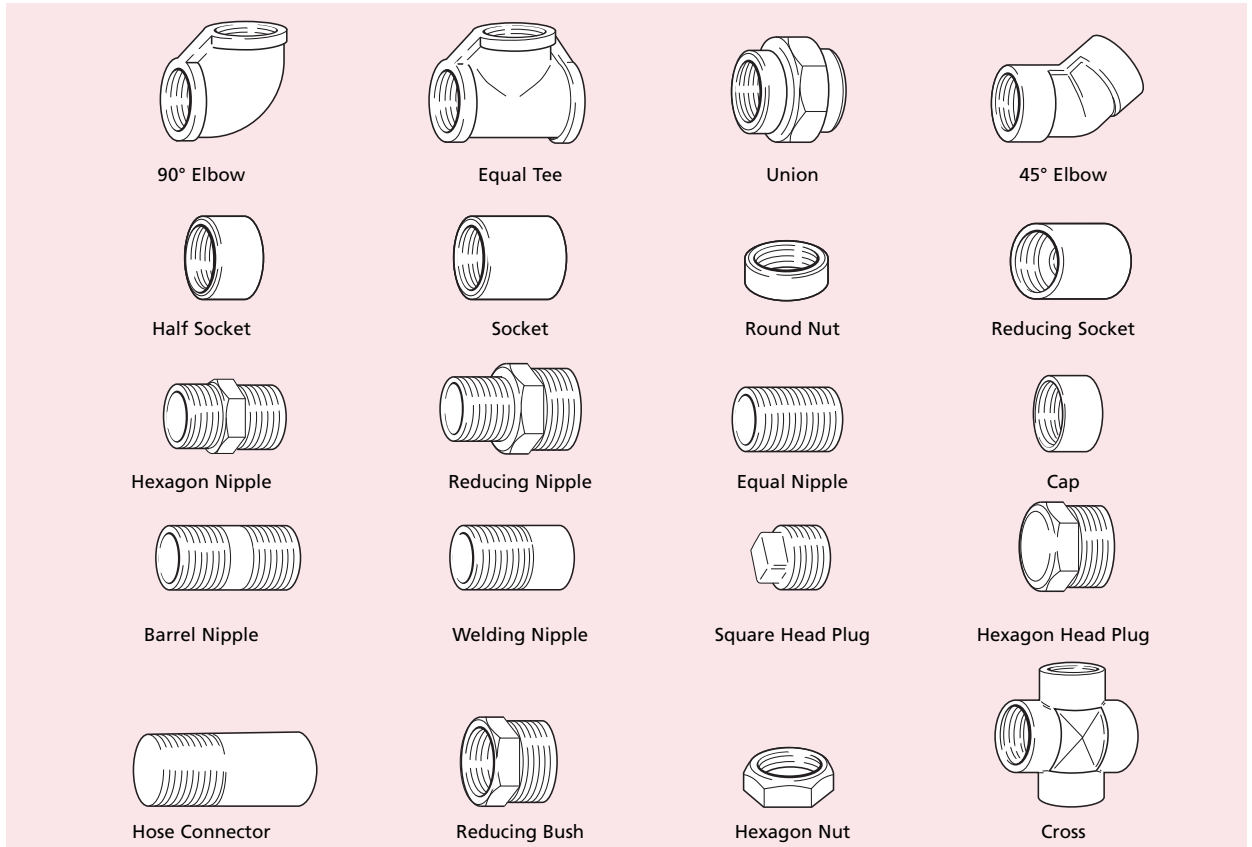

- BSP fittings are a family of fittings used to connect up threaded pipe and equipment.
- They are manufactured from pipe, bar, hollow bar, castings or forgings.
- The pipe to be threaded must have a wall thickness of Schedule 40S minimum.
- The fittings are used in non-critical, low pressure applications where welding is not possible or required. They therefore provide a relatively low cost method of connection.
- BSP fittings are usually fitted with a sealant (paste or tape such as PTFE) and are considered to be permanent pipe-work.
- Low Pressure BSP Fittings are rated at 150lb and are made to wrought iron specification BS 1740.
- BSP fittings are made only in type 316.
- They are provided with a Certificate of Conformity only, and not a full Test Certificate.
- Sizes 1/8 to 3 inch are the most commonly used and thus the most readily available.
- External MALE threads are tapered and Internal FEMALE threads are parallel. The threads are cut to BS21: Part 1: 1985 and are called Whitworth Threads – See below.

Nominal size of outlet		Min O/D	Min O/D of body behind external thread	Min I/D of body behind internal thread	No. of threads per inch
in	mm	mm	mm	mm	
1/8	6	15.0	9.8	8.6	28
–	8	18.5	13.3	11.4	19
3/8	10	22.0	16.8	15.0	19
–	15	27.0	21.1	18.6	14
–	20	32.5	26.6	24.1	14
1	25	39.5	33.4	30.3	11
1	32	49.0	42.1	39.0	11
1	40	56.0	48.0	44.8	11
2	50	68.0	59.8	56.7	11
2	65	84.0	75.4	72.2	11
3	80	98.0	88.1	84.9	11
4	100	124.0	113.3	110.1	11
5	125	151.0	138.7	135.5	11
6	150	178.0	164.1	160.9	11

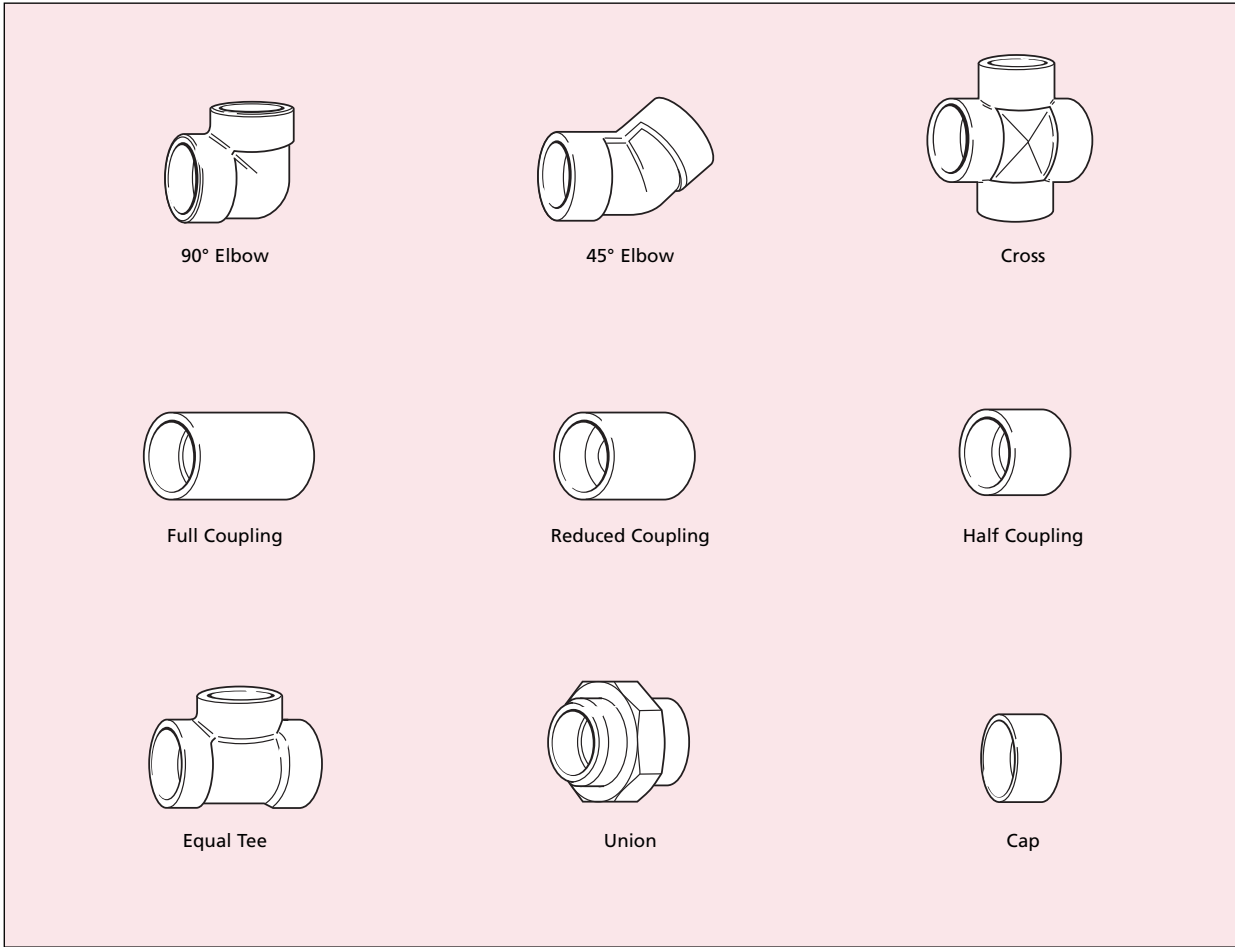

- Socket Weld Fittings are a family of fittings used in joints for high pressure pipe-work systems. Circumferential socket welds are used to incorporate these fitting into the joints.
- They are used only in conjunction with ANSI Pipe and are available in the same size range.
- They are used in areas where pipe-work is permanent and is designed to provide good flow characteristics.



- Socket Weld Fittings are produced to BS 3799, ASTM A182 & ANSI B16.11 as applicable.
- They are available in four pressure ratings: 2000lb, 3000lb, 6000lb & 9000lb.
- The same range of high pressure fittings is also available with screwed ends with NPT threads.



Aalco stocks all of the commonly required forms of aluminium including sheet, coil, strip, plate, shate, treadplate, patterned sheet, tube, bar, sections and free-machining rod. In addition to a comprehensive range of standard shapes and sizes, Aalco Service Centres stock industry specific items and custom specials with numerous specialist products and alloys satisfying the needs of a broad range of industries. Aalco also provides a complete range of processing services including: bar; tube & pipe cutting; plate processing; coil processing and surface finishing.

Rolled Products

Plate	Finstock
Sheet	Treadplate
Shate	Patterned Sheet



Extrusions

Round, Flat, Hexagon & Square Bar
 Tube & Scaffold Tube
 Angle (Equal & Unequal)
 Channel
 Tee
 Square & Rectangular Box Section



Customer Special Extrusions

Aalco are the UK's largest purchaser of aluminium extrusions with an annual throughput approaching 20,000 tonnes, This gives Aalco unrivalled purchasing power and sourcing expertise, which is shared with its customers.

As a major customer of many leading extrusion mills, Aalco has access to the widest possible range of alloys, shapes and sizes. In-depth knowledge of each mill's particular specialities means Aalco customers are assured that their extrusions will be sourced from the most cost-effective source.

The stock range includes special alloys, shapes and sizes for many industries including building, marine, road transport, signage, leisure & sporting goods, engineering and aerospace.

A particular skill is the sourcing of bespoke extrusions, designed for individual customers – from single shapes to full suites. Many customers have found major benefits in sourcing from Aalco, rather than direct from the mill. These benefits include time saving, reduced costs, flexibility, the possibility to make regular changes in scheduled quantities, keeping abreast of technology changes, assistance with design and technical issues, all without sacrificing choice or quality. What's more, Aalco's purchasing power means all this can be achieved at a very competitive price.

The processing services provided for aluminium extrusions include:

- **Cut lengths** Single Pieces up to 16"/406mm diameter through to High Volume Repetition Cutting
- **Prefabrication** Drilling, Notching, Punching & Bending
- **Finishing** Anodising, Painting/Powder coating, Polishing, Chromating
- **Protection Coating or Sleaving**
- **Special Packaging including 'Kitting'.**

Other Product Ranges

Aalco, in addition to a wide range of standard products, also stock a huge selection of special items for particular industries and individual customers.

- **Building** Painted Sheet & Extrusions, Patterned Sheet & Treadplate
- **Road Transport** Sections, Castings, Plate & Shate, Patterned Sheet & Treadplate
- **Road Signs** Sheet, Blanks, Painted Sheet, Extrusions
- **Marine** Sections, Plate, Sheet, Treadplate, Transition Joints
- **Holloware** Deep drawing Quality Sheet, Circles & Rings
- **Process Plant** Pipe, Butt Weld Fittings & Flanges, Treadplate



Aluminium is the world's most abundant metal and is the third most common element, comprising 8% of the earth's crust. The versatility of aluminium makes it the most widely used metal after steel.

Although aluminium compounds have been used for thousands of years, aluminium metal was first produced around 170 years ago.

In the 120 years since the first industrial quantities of aluminium were produced, worldwide demand for aluminium has grown to around 29 million tons per year. About 22 million tonnes is new aluminium and 7 million tonnes is recycled aluminium scrap. The use of recycled aluminium is economically and environmentally compelling. It takes 14,000 kWh to produce 1 tonne of new aluminium. Conversely it takes only 5% of this to remelt and recycle one tonne of aluminium. There is no difference in quality between virgin and recycled aluminium alloys.

Pure aluminium is soft, ductile, corrosion-resistant and has a high electrical conductivity. It is widely used for foil and conductor cables, but alloying with other elements is necessary to provide the higher strengths needed for other applications. Aluminium is one of the lightest engineering metals, having a strength-to-weight ratio superior to steel.

By utilising various combinations of its advantageous properties such as strength, lightness, corrosion resistance, recyclability and formability, aluminium is being employed in an ever-increasing number of applications. This array of products ranges from structural materials through to thin packaging foils.

Properties

The major advantages of using aluminium are tied directly to its remarkable properties. Some of these properties are outlined in the following sections.

Strength-to-Weight Ratio

Aluminium has a density around one-third that of steel and is used advantageously in applications where high strength and low weight are required. This includes vehicles where low mass results in greater load capacity and reduced fuel consumption.

Corrosion Resistance

When the surface of aluminium metal is exposed to air, a protective oxide coating forms almost instantaneously. This oxide layer is corrosion-resistant and can be further enhanced with surface treatments, such as anodising.

Electrical and Thermal Conductivity

Aluminium is an excellent conductor of both heat and electricity. The great advantage of aluminium is that by weight, the conductivity of aluminium is around twice that of copper. This means that aluminium is now the most commonly used material in large power transmission lines.

The best alternatives to copper are aluminium alloys in the 1000 or 6000 series. These can be used for all electrical conduction applications, including domestic wiring.

Weight considerations mean that a large proportion of overhead, high-voltage power lines now use aluminium rather than copper. They do however, have a low strength and need to be reinforced with a galvanised or aluminium coated high-tensile steel wire in each strand.

Light and Heat Reflectivity

Aluminium is a good reflector of both visible light and heat, making it an ideal material for light fittings, thermal rescue blankets and architectural insulation.

Toxicity

Aluminium is not only non-toxic but also does not release any odours or taint products with which it is in contact. This makes aluminium suitable for use in packaging for sensitive products such as food or pharmaceuticals where aluminium foil is used.

Recyclability

The recyclability of aluminium is unparalleled. When recycled, there is no degradation in properties when recycled aluminium is compared to virgin aluminium. Furthermore, melting for the recycling of aluminium only requires around 5 percent of the input energy required to produce virgin aluminium metal.

Aluminium Production

Aluminium is extracted from the principal ore, bauxite. Significant bauxite deposits are found in Australia, the Caribbean, Africa, China and South America. Open cast techniques are commonly used to mine the bauxite.

The bauxite is purified using the Bayer process. This process involves dissolving aluminium trihydrate to leave alumina plus iron and titanium oxides. The iron and titanium oxides are by-products of the process and are often referred to as 'red mud'. Red mud must be disposed of with strong consideration given to environmental concerns.

Approximately four tonnes of bauxite are required to yield two tonnes of alumina, which yields one tonne of aluminium.

Smelting

The extraction of aluminium from alumina is achieved using an electrolytic process. A cell or pot is used that consists of a carbon lined steel shell. This shell forms a cathode. A consumable carbon anode is suspended in liquid cryolite (sodium aluminium fluoride) held within the pot at 950°C. Alumina is dissolved in the cryolite by passing low voltages at high amperages through the pot. This results in pure aluminium being deposited at the cathode.



Environmental Considerations

The aluminium industry is very conscious of the environmental impact of its activities. The mining and smelting of aluminium, plus the disposal of red mud can have a major environmental impact if not done properly.

The industry is proud of its efforts and achievements in rehabilitating open cast mine sites and the restoring flora and fauna to these sites. Such efforts have been rewarded with awards from the United Nations Environment Programme and red mud disposal areas are now being successfully revegetated.

Environmental requirements are met on pot line emissions through the use of specialist scrubbing system.

Recycling

The combination of two remarkable properties of aluminium makes the need to recycle the metal obvious. The first of these factors is that there is no difference between virgin and recycled aluminium. The second factor is that recycled aluminium only uses 5% of the energy required to produce virgin material.

Currently around 60-70% of aluminium metal is recycled at the end of its lifecycle but this percentage can still be vastly improved.

Applications

The properties of the various aluminium alloys has resulted in aluminium being used in industries as diverse as transport, food preparation, energy generation, packaging, architecture, and electrical transmission applications.

Depending upon the application, aluminium can be used to replace other materials like copper, steel, zinc, tin plate, stainless steel, titanium, wood, paper, concrete and composites.

Some examples of the areas where aluminium is used are given in the following sections.

Packaging

Corrosion resistance and protection against UV light combined with moisture and odour containment, plus the fact that aluminium is non-toxic and will not leach or taint the products has resulted in the widespread use of aluminium foils and sheet in food packaging and protection.

The most common use of aluminium for packaging has been in aluminium beverage cans. Aluminium cans now account for around 15% of the global consumption of aluminium.

Transport

After the very earliest days of manned flight, the excellent strength-to-weight ratio of aluminium have made it the prime material for the construction of aircraft.

The attractive properties of aluminium mean various alloys are now also used in passenger and freight rail cars, commercial vehicles, military vehicles, ships & boats, buses & coaches, bicycles and increasingly in motor cars.

The sustainable nature of aluminium with regards to corrosion resistance and recyclability has helped drive the recent increases in demand for aluminium vehicle components.

Marine Applications

Aluminium plate and extrusions are used extensively for the superstructures of ships. The use of these materials allows designers to increase the above waterline size of the vessel without creating stability problems. The weight advantage of aluminium has allowed marine architects to gain better performance from the available power by using aluminium in the hulls of hovercraft, fast multi-hulled catamarans and surface planing vessels.

Lower weight and longer lifecycles have seen aluminium become the established material for helidecks and helideck support structures on offshore oil and gas rigs. The same reasons have resulted in the widespread use of aluminium in oil rig stair towers and telescopic personnel bridges.

Building and Architecture

Aluminium use in buildings covers a wide range of applications. The applications include roofing, foil insulation, windows, cladding, doors, shop fronts, balustrading, architectural hardware and guttering.

Aluminium is also commonly used in the form of treadplate and industrial flooring.

Foils

Aluminium is produced in commercial foils as thin as 0.0065 mm (or 6.5 µm). Material thicker than 0.2mm is called sheet or strip.

Aluminium foil is impervious to light, gases, oils and fats, volatile compounds and water vapour. These properties combined with high formability, heat and cold resistance, non-toxicity, strength and reflectivity to heat and light mean aluminium foil is used in many applications.

These applications include:

- Pharmaceutical packaging
- Food protection and packaging
- Insulation
- Electrical shielding
- Laminates

Other Applications

The above applications account for approximately 85% of the aluminium consumed annually.

The remaining 15% is used in applications including:

- Ladders
- High pressure gas cylinders
- Sporting goods
- Machined components
- Road barriers and signs
- Furniture
- Lithographic printing plates

Alloy Designations

Aluminium is most commonly alloyed with copper, zinc, magnesium, silicon, manganese and lithium. Small additions of chromium, titanium, zirconium, lead, bismuth and nickel are also made and iron is invariably present in small quantities.

There are over 300 wrought alloys with 50 in common use. They are normally identified by a four figure system which originated in the USA and is now universally accepted. Table 1 describes the system for wrought alloys. Cast alloys have similar designations and use a five digit system.

Designations for wrought aluminium alloys

Alloying Element	Wrought
None (99%+ Aluminium)	1XXX
Copper	2XXX
Manganese	3XXX
Silicon	4XXX
Magnesium	5XXX
Magnesium + Silicon	6XXX
Zinc	7XXX
Lithium	8XXX

For unalloyed wrought aluminium alloys designated 1XXX, the last two digits represent the purity of the metal. They are the equivalent to the last two digits after the decimal point when aluminium purity is expressed to the nearest 0.01 percent. The second digit indicates modifications in impurity limits. If the second digit is zero, it indicates unalloyed aluminium having natural impurity limits and 1 through 9, indicate individual impurities or alloying elements.

For the 2XXX to 8XXX groups, the last two digits identify different aluminium alloys in the group. The second digit indicates alloy modifications. A second digit of zero indicates the original alloy and integers 1 to 9 indicate consecutive alloy modifications.

Physical Properties

Density

Aluminium has a density around one-third that of steel or copper making it one of the lightest commercially available metals. The resultant high strength to weight ratio makes it an important structural material, allowing increased payloads or fuel savings for transport industries in particular.

Strength

Pure aluminium doesn't have a high tensile strength. However, the addition of alloying elements like manganese, silicon, copper and magnesium can increase the strength properties of aluminium and produce an alloy with properties tailored to particular applications.

Aluminium is well suited to cold environments. It has the advantage over steel in that its tensile strength increases with decreasing temperature, while retaining its toughness. Steel, on the other hand, becomes brittle at low temperatures.

Corrosion Resistance

When exposed to air, a layer of aluminium oxide forms almost instantaneously on the surface of aluminium. This layer has excellent resistance to corrosion. It is fairly resistant to most acids but less resistant to alkalis.

Thermal Conductivity

The thermal conductivity of aluminium is about three times greater than that of steel. This makes aluminium an important material for both cooling and heating applications such as heat-exchangers. Combined with it being non-toxic, this property means aluminium is used extensively in cooking utensils and kitchenware.

Electrical Conductivity

Along with copper, aluminium has an electrical conductivity high enough for use as an electrical conductor. Although the conductivity of the commonly used conducting alloy (1350) is only around 62% of annealed copper, it is only one-third the weight and can therefore conduct twice as much electricity when compared with copper of the same weight.

Reflectivity

From UV to infra-red, aluminium is an excellent reflector of radiant energy. Visible light reflectivity of around 80% means it is widely used in light fixtures. The same properties of reflectivity makes aluminium ideal as an insulating material to protect against the sun's rays in summer, while insulating against heat loss in winter.

Typical properties for aluminium

Property	Value
Atomic Number	13
Atomic Weight (g/mol)	26.98
Valency	3
Crystal Structure	FCC
Melting Point (°C)	660.2
Boiling Point (°C)	2480
Mean Specific Heat (0-100°C) (cal/g.°C)	0.219
Thermal Conductivity (0-100°C) (cal/cms. °C)	0.57
Co-Efficient of Linear Expansion (0-100°C) (x10-6/°C)	23.5
Electrical Resistivity at 20°C (μ_.cm)	2.69
Density (g/cm ³)	2.6898
Modulus of Elasticity (GPa)	68.3
Poissons Ratio	0.34

Mechanical Properties

Aluminium can be severely deformed without failure. This allows aluminium to be formed by rolling, extruding, drawing, machining and other mechanical processes. It can also be cast to a high tolerance.

Alloying, cold working and heat-treating can all be utilised to tailor the properties of aluminium.

The tensile strength of pure aluminium is around 90 MPa but this can be increased to over 690 MPa for some heat-treatable alloys.

The EN standards differ from the old standard, BS 1470 - BS 1475 in the following areas:

- Chemical compositions – unchanged.
- Alloy numbering system – unchanged.

- Temper designations for heat treatable alloys now cover a wider range of special tempers. Up to four digits after the T have been introduced for non-standard applications (e.g. T6151).
- Temper designations for non heat treatable alloys – existing tempers are unchanged but tempers are now more comprehensively defined in terms of how they are created. Soft (O) temper is now H111 and an intermediate temper H112 has been introduced. For alloy 5251 tempers are now shown as H32/H34/H36/H38 (equivalent to H22/H24, etc). H19/H22 & H24 are now shown separately.
- Mechanical properties – remain similar to previous figures. 0.2% Proof Stress must now be quoted on test certificates.

Mechanical properties of selected aluminium alloys

Alloy	Temper	Proof Stress 0.2% (MPa)	Tensile Strength (MPa)	Shear Strength (MPa)	Elongation A5 (%)	Hardness Vickers (HV)
AA1050A	H12	85	100	60	12	30
	H14	105	115	70	10	36
	H16	120	130	80	7	-
	H18	140	150	85	6	44
	O	35	80	50	42	20
AA2011	T3	290	365	220	15	100
	T6	300	395	235	12	115
AA3103	H14	140	155	90	9	46
	O	45	105	70	29	29
AA4015	O	45	110-150	-	20	30-40
	H12	110	135-175	-	4	45-55
	H14	135	160-200	-	3	-
	H16	155	185-225	-	2	-
	H18	180	210-250	-	2	-
AA5083	H32	240	330	185	17	95
	O/H111	145	300	175	23	75
AA5251	H22	165	210	125	14	65
	H24	190	230	135	13	70
	H26	215	255	145	9	75
	O	80	180	115	26	46
AA5754	H22	185	245	150	15	75
	H24	215	270	160	14	80
	H26	245	290	170	10	85
	O	100	215	140	25	55
AA6063	O	50	100	70	27	85
	T4	90	160	11	21	50
	T6	210	245	150	14	80
AA6082	O	60	130	85	27	35
	T4	170	260	170	19	75
	T6	310	340	210	11	100
AA6262	T6	240	290	-	8	-
	T9	330	360	-	3	-
AA7075	O	105-145	225-275	150	9	65
	T6	435-505	510-570	350	5	160

Heat Treatment

A range of heat treatments can be applied to aluminium alloys:

- Homogenisation – the removal of segregation by heating after casting.
- Annealing – used after cold working to soften work-hardening alloys (1XXX, 3XXX and 5XXX).
- Precipitation or age hardening (alloys 2XXX, 6XXX and 7XXX).
- Solution heat treatment before ageing of precipitation hardening alloys.
- Stoving for the curing of coatings.

After heat treatment a suffix is added to the designation numbers.

- The suffix F means “as fabricated”.
- O means “annealed wrought products”.
- T means that it has been “heat treated”.
- W means the material has been solution heat treated.
- H refers to non heat treatable alloys that are “cold worked” or “strain hardened”.

The non-heat treatable alloys are those in the 3XXX, 4XXX and 5XXX groups.

EN Heat treatment designations

Term	Description
T1	Cooled from an elevated temperature shaping process and naturally aged.
T2	Cooled from an elevated temperature shaping process cold worked and naturally aged.
T3	Solution heat-treated cold worked and naturally aged to a substantially.
T4	Solution heat-treated and naturally aged to a substantially stable condition.
T5	Cooled from an elevated temperature shapin process and then artificially aged.
T6	Solution heat-treated and then artificially aged.
T7	Solution heat-treated and overaged/stabilised.

Work Hardening

The non-heat treatable alloys can have their properties adjusted by cold working. Cold rolling is a typical example.

These adjusted properties depend upon the degree of cold work and whether working is followed by any annealing or stabilising thermal treatment.

Nomenclature to describe these treatments uses a letter, O, F or H followed by one or more numbers. As outlined in Table 6, the first number refers to the worked condition and the second number the degree of tempering.

Non-Heat treatable alloy designations

Term	Description
H1X	Work hardened
H2X	Work hardened and partially annealed
H3X	Work hardened and stabilized by low temperature treatment
H4X	Work hardened and stoved
HX2	Quarter-hard – degree of working
HX4	Half-hard – degree of working
HX6	Three-quarter hard – degree of working
HX8	Full-hard – degree of working

Temper codes for plate

Code	Description
H112	Alloys that have some tempering from shaping but do not have special control over the amount of strain-hardening or thermal treatment. Some strength limits apply.
H321	Strain hardened to an amount less than required for a controlled H32 temper.
H323	A version of H32 that has been specially fabricated to provide acceptable resistance to stress corrosion cracking.
H343	A version of H34 that has been specially fabricated to provide acceptable resistance to stress corrosion cracking.
H115	Armour plate.
H116	Special corrosion-resistant temper.



Aluminium materials are characterised by their lightness, strength, corrosion resistance, high durability and formability, leading to a wide range of product forms and extensive use in engineering applications. However, despite its high durability and corrosion resistance, some simple steps should be employed when handling and cleaning aluminium to avoid staining and damage, as some alloys tend to be quite soft.

Receiving Material

In many cases aluminium components are supplied with a polished surface that is protected by a strippable plastic or paper coating. Upon receipt, the coating should be inspected for any damage that might have been transferred to the underlying aluminium.

Upon receipt, materials should also be inspected for signs of wetness to avoid the possibility of water staining. This should include looking for wet packaging or pallets.

Materials should also be moved indoors for storage into dry conditions. This should be done immediately on damp or rainy days.

Handling

To avoid damage to the surface of aluminium components, some care is needed in handling.

This includes:

- Avoid allowing aluminium to scrape against hard or sharp surfaces
- Two people should be used when stacking/unstacking or moving sheets to avoid dragging them over one another
- Do not drag or throw aluminium components
- In order to avoid distortion or damage, use soft slings when lifting heavy components
- Do not walk over sheets whilst moving them.

Storage

If being stored for extended periods, aluminium should be lightly oiled and stored vertically to ensure air circulation over all surfaces.

Aluminium should be stored indoors, in a clean, dry, dust and contaminant free environment and not be in contact with other materials.

Water staining

A common problem with aluminium is water staining. Water staining is generally a white powdery substance on the surface of the aluminium, but depending on the alloy or amount of oxidation it may have an iridescent appearance. It is caused by the entrapment of moisture between the surfaces of closely packed aluminium. High magnesium alloys produce the most water stain. The only detrimental effect of water staining is aesthetic, as it doesn't alter the mechanical properties of aluminium.

If material is delivered wet, it should be allowed to dry thoroughly before storage. This should be done by evaporation using dry air. Removal of the moisture will prevent stains occurring and halt the growth of any existing water stains.

The extent of existing stains can be determined by surface roughness. Light staining will be smooth and can be removed by brushing. For extensive staining (rough surface) dipping in an aqueous solution of 10% by volume sulphuric acid and 3% by weight chromic acid may be required.

Installation

Installation and delivery of aluminium components should always be delayed to the last possible moment to avoid accidental staining and/or damage.

Newly installed aluminium components most commonly require cleaning due to carelessness with nearby work procedures. This results in staining from such things as mortar, concrete and paints.

This can be avoided or minimized by protecting aluminium surfaces with a clear lacquer or light oil. If the aluminium is tainted with a wet product it should be removed before drying and washed thoroughly with water. If dry mortar, plaster or paint needs to be removed from aluminium by scraping, use a plastic or wooden scraper. Metal scrapers will damage the surface of the aluminium.

Maintenance

The best way to keep aluminium looking pristine is regular cleaning to remove any build up of dirt. If left for an extended period of time, grime can cause staining and, depending on the extent of staining, will require a harsher cleaning system to remove the stain. In cleaning aluminium one should always start with the mildest method possible and only move to successively harsher treatments if absolutely necessary.

Cleaning Methods

The cleaning methods in ascending order of harshness are:

- Plain water
- Mild soap / detergent
- Solvents such as kerosene, turpentine or white spirit
- Non-etching chemical cleaner
- Wax-based polish
- Abrasive wax
- Abrasive cleaner

After cleaning, the aluminium should be washed thoroughly and dried to prevent streaking. Special care should be taken to remove any traces of cleaner from edges and joints. Always follow manufacturers' recommendations when using proprietary cleaning products.

Abrasive cleaners can alter the appearance of polished aluminium or aluminium with a 'grain' finish. If the aluminium has a grain, always clean with the grain.

Aluminium alloys are normally supplied as semi-finished products such as sheet, plate, coil, extrusions, tube or wire. All forms can then be readily fabricated into finished products using a wide range of processes.

Aalco provides a range of cutting and pre-fabrication services including coil slitting, cut-to-length and guillotining of sheet and plate, cut lengths of extrusion and tube, polishing, coating, drilling, slotting, bending and weld preparation of edges.

Cutting

Aluminium can be cut by many different methods, depending on the shape and form of the aluminium. Aluminium plate is cut with various types of saw and also laser, plasma or water jet to produce finished sizes that can have intricate shapes. The advantage of water jet cutting is the lack of heat and therefore no alteration of the properties of the aluminium.

Aluminium extrusion and tube is routinely cut with carbon tipped circular saw blades. Blade cutting can be improved by using a stick wax on the blade to improve lubrication. Other cutting methods include band-sawing and guillotining.

Aalco routinely supply plate cut to size including circles, rings and irregular shapes.

Grades, Tempers and Formability

When producing an aluminium product, the grade selection must be made with consideration given to not only the durability of the alloy when in service, but also if the product can be readily fabricated from that material.

Although the formability of an aluminium alloy relates directly to the type of alloy, the temper of each alloy can change properties in such a way that the same grade may be perfect for a given application in one temper, but completely unsuited in another.

General fabrication properties of the various alloy series are given in Table 1.

Table 1. Fabrication properties of aluminium alloys

Alloy	Properties
1XXX	Excellent formability, weldability and corrosion resistance. Low strength.
2XXX	Excellent machinability and high strength. Poor formability, weldability and corrosion resistance.
3XXX	Formable, corrosion resistant and weldable. Moderate strength.
4XXX	Formable, weldable, corrosion resistant.
5XXX	Formable, weldable, excellent corrosion resistance.
6XXX	Formable, corrosion resistant, medium-to-high-strength.
7XXX	Machinable, poor corrosion resistance and weldability. High strength.
8XXX	Excellent formability.

For non-heat treatable alloys additional strength is imparted to the alloy by work hardening. The alloy can then be softened to the desired properties by heating in an annealing stage.

For heat treatable alloys, strength is imparted by heating followed by quenching and ageing. Quenching is a rapid cooling process using air or water.

Deep Drawing

Deep drawing is a common fabrication method for aluminium and is the process used to make one of the world's most common aluminium products; aluminium drinks cans. Deep drawing uses extremely high forces to push a sheet or blank of a relatively soft alloy into a female draw cavity. Several stages are used in the process and appropriate lubrication is required.

Deep drawing is a valued fabrication method as it produces a seamless product. Due to the forming method, products manufactured by deep drawing essentially have a cup like shape. Aluminium alloys used for deep drawing include 3003, 5005, and 5052.

Bending

Aluminium can be bent using any one of a number of different techniques. The choice of the most appropriate is dictated by factors such as the form and temper of the alloy in question.

The most common form of aluminium that is bent is tubing. When tube is to be bent, drawn tube should be specified as it bends more consistently and to tighter tolerances than extruded tube.

Four main methods are used for bending aluminium:

- Three roll bending
- Three point bending
- Wrap and mandrel bending
- Stretch forming

Three Roll Bending

Three roll benders use a central roller that is moveable and is gradually depressed on the work piece until the desired radius is achieved.

Three Point Bending

Similar to three roll bending, the three point bender can apply a load via an impact or gradually. Both three roll and three point bending are used on strong sections.

Wrap and Mandrel Bending

Wrap and mandrel benders use formers and support tools to bend the aluminium to tight radii while minimising buckling. In wrap bending the former moves around the section. Mandrel bending differs in that the section moves around the former.

Stretch Forming

Stretch formers work with the section in tension being wrapped around a former. With the section in tension, compression failure is minimised.



Bend Radii

To avoid cracking when bending aluminium, the bend radius must be considered.

Minimum allowable bend radii are functions of the alloy, temper, cross sectional dimensions, mandrel use and the required surface finish. It is therefore not possible to give strict rules to the bend radii for all instances. Published bend radii tables should be consulted before bending and practical trials done before bending the work-piece.

Joining

The most common way of joining aluminium is welding. Most alloys of aluminium are able to be easily welded once a couple of factors are taken into consideration.

The corrosion resistance of aluminium is due to a tough oxide layer on the surface. This oxide layer has a higher melting point than aluminium and must be removed before welding. It is removed using chemical, mechanical or electrical means and must be prevented from reforming before welding can be completed.

Due to the high thermal conductivity of aluminium, heat needs to be applied at a rate four times that needed for steel. It has a linear expansion coefficient twice that for steel, which must be considered when welding material that has been restrained.

Aluminium has a relatively low melting point and unlike steel, it does not change colour as its melting point is approached.

Consequently, care must be taken not to overheat and/or melt aluminium during joining processes.

Welding tends to reduce the mechanical properties of aluminium in the heat affected zone. This area extends around 25mm from the weld.

Fusion Welding

For economic and quality reasons, MIG and TIG welding are the recommended methods for welding aluminium.

TIG and MIG Welding

TIG welding is suited to joining of lighter gauge materials with section thicknesses from about 0.8 to 12.5mm. It is also suited to the joining of pipes, ducting and intricate welds. Joints can be butts, lap welds, edge welds and fillets.

MIG welding allows for a high current density with deep penetration and welding speeds higher than for TIG. This means less total heat input and less chance of distortion. The process of TIG and MIG welding automatically removes the oxide layer electronically.

During the positive cycle of AC current, aluminium oxide particles are stripped from the weld pool allowing the fusion of oxide free metal in the next cycle.

Some pre-cleaning of the joint for welding is still required to ensure the weld is completely free of oxide.

Filler Alloys

Filler wires for MIG and TIG welding are restricted to pure aluminium, Al-Mg and Al-Si alloys.

Resistance Welding

For aluminium alloys, spot, seam, wire and flash welding are the most common types of resistance welding.

They all result in excellent joints, particularly with high-strength heat-treatable alloys. Resistance welding can be more economical than fusion welding but is not suited to all applications.

Friction Welding

It is not uncommon for a brittle zone to be created when aluminium is fusion welded to dissimilar metals. Friction welding can be used to overcome this problem. Processes such as friction stir welding have been found to be suited to the joining of aluminium alloys.

Brazing

Aluminium can be brazed by torch, dip or furnace processes as long as close temperature control is maintained.

Welding to Dissimilar Metals

Large differences in properties such as melting point, thermal conductivity and thermal expansion mean welding aluminium to dissimilar metals such as steel is extremely difficult and often impossible in extreme environments such as ship repair and offshore oil rigs.

In these instances explosion bonded transition joints are used. Structural Transition Joints (STJ) are bimetallic strips of material with a cross section that has an appropriate aluminium alloy on one side and a dissimilar material like steel on the other. The STJ is used to form a filler bridge between the dissimilar metals with each metal welded directly to the corresponding metal on the STJ.



Soldering

The oxide coating on aluminium and its high thermal conductivity makes soldering difficult. The larger the part being soldered, the more evident this becomes. A small part can be held at soldering temperature but a large part can become distorted as one section might be hot while another remains cold.

Fluxes used to remove the oxide layer can be corrosive and must be removed after soldering. To solder without flux the surface needs to be covered in molten flux and the surface below the liquid flux abraded before the two surfaces are joined.



Adhesive Bonding

As welding tends to reduce properties in the heat affected zone, aluminium parts are being increasingly joined with adhesives. Adhesives are now used for joining aluminium in structural applications such as aircraft flooring, vehicle body panels and even attaching street light poles to their bases.

The adhesive bonding of aluminium has grown in importance since the 1930's when it was observed that hot curing wood adhesives also worked extremely well on the surfaces of some metals. New technologies in the area of synthetic adhesives promise to further increase the importance of adhesive bonding for aluminium.

When adhesive bonding is used with aluminium, it is generally found that no bonding occurs between the adhesive and the aluminium metal. Rather the adhesive bonds to the aluminium oxide layer. Acid etching can be used as a surface preparation to create a bond directly to the aluminium. Surface preparation is dependant upon the type of adhesive being used and should be done in accordance with manufacturers recommendations.

It is also not adequate to simply use adhesive on a joint that would otherwise be welded or mechanically fastened. Joint design for adhesive bonding should

allow for maximum surface contact between the adhesive and the aluminium. The joint design should also consider the loading forces that the joint will endure. Adhesive bonding performs best when the forces are predominantly pure shear, tension or compression. The use of lap joints is common as they have a large joint surface area, load predominantly in tension and avoid cleaving or peeling forces.

Mechanical Joints

From small aluminium boats to aircraft, riveting is still used to make joints. Riveting, screwing and bolting can produce high strength joints without distortion or strength loss and requires less skill than for other joining methods.

Aluminium alloys used for rivets include 2017A, 2024, 5056, 5052, 5754, 6061, 6082 and 7075.

Machining

Although readily machinable, aluminium has a high coefficient of friction and high thermal coefficient of expansion. This means a special approach is required, including the use of polished tools with different tool geometry and good lubrication to avoid thermal stress.

Aluminium alloy 2011 is referred to as a free machining alloy (FMA) due to its excellent machining properties. 2011 has poor corrosion resistance and which leads to 6262 T9 being used when greater corrosion resistance is required.

Both 2011 and 6262 are commonly supplied in bar form. When machining of plate aluminium is required, the grade selected is 6082. Alloy 6082 machines very well and produces tight coils of swarf when chip breakers are used.

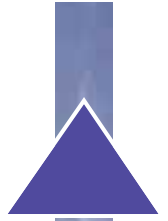

Filing and Grinding

Normal files and grinding wheels become clogged with aluminium filings. When rough filing aluminium the file should have deeply cut curved teeth with only around 4 teeth per centimetre. A long angle lathe file with 6 to 8 teeth per centimetre can be used for finer work and should be cleaned with a wire brush.

Chalk can be rubbed into the file to reduce clogging and immersion in a 20% caustic soda solution will dissolve the aluminium and clean the teeth.

For grinding, specialist wheels can be used. For coarse grinding use felt, leather or rubber covered discs with 60 to 120 grit emery or corundum abrasive and a paraffin lubricant. For fine grinding use 160 to 320 grit emery abrasive and small amounts of lubricant.

Finishing

Aluminium can be finished using mechanical, chemical, anodising and organic processes. Aalco has extensive polishing facilities to provide a range of finishes to meet every application.

Mechanical Finishing

Mechanical finishing most commonly involves grinding and polishing.

Grinding utilises an abrasive wheel attached to a rotary grinder. The preferred method is low speed grinding with aluminium oxide to avoid surface overheating.

Polishing uses wheels or belts with abrasives bonded to them. A buffing step can be included to remove any emery marks. Buffing wheels are usually made of muslin discs sewn together.

Chemical Finishing

Chemical finishes react with the metal surface to alter its form. They include conversion coatings and etching.

Conversion coatings thicken the natural oxide coating and allow for better bonding with paints, lacquers and other coatings. Chemical conversion films are thinner and cheaper than those produced by anodising.

Etching uses a chemical to attack and roughen the metal surface. Etching media can be either acid or alkaline. Alkaline etchants are cheaper and easier to handle, therefore more common. The most widely used is a solution of caustic soda in water. As etching removes the protective oxide layer, another step is required to restore it.

As chemical finishing involves the removal of metal to create a pattern or polish, it does result in a minor overall reduction in metal thickness.

Anodising

Anodising is an electrolytic process that is used to increase the thickness of the surface oxide films on aluminium. The resultant films are hard, durable and inert and have better corrosion resistance and strength compared to finishes produced by chemical processes. The anodic films are normally between 5 and 25 microns thick depending on the end use, in particular how aggressive the end-use environment. Anodic films can also be used as a base for dyes of any colour.



Chromate Conversion Coatings

Chromate conversion coating or chromating, is a process that coats aluminium with an extremely thin chemical coating. This coating can be used to impart enhanced corrosion resistance, conductivity and bonding ability to the aluminium substrate.

Chromating uses an aqueous solution containing chromates and certain activator ions to dissolve some of the base metal. This metal enters the solution as metal ions where it combines with the chromate ions and reforms on the metal surface as an adherent coating.

The advantage of chromating over anodising includes it not being an electrical process. This means electrical contact does not need to be made with the part and coating can be done on a bulk scale. This makes chromating generally faster, easier and therefore cheaper.

Two categories of chromates are used for aluminium:

- Chrome phosphates are primarily used on architectural aluminium extrusions to provide a paint-bonding coat.
- Chrome oxides are used on almost every type of aluminium including sheet, coil, castings and stampings. They are used to increase corrosion resistance and to enhance paint bonding.







Organic Coatings

Organic coatings include paint systems such as alkyd, acrylic, vinyl and epoxy coatings.

Organic coatings are commonly employed on aluminium for siding, awnings and aluminium cans.

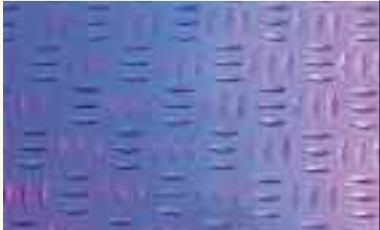
They are typically applied using continuous processes while the aluminium sheet is still in coil form. Such coatings can be applied to one or both sides and more than one coat can be applied per side.

The Core Product Ranges are:

<p>Plate Alloys 6082 & 5083 in thicknesses 4 to 25mm Also aerospace release material. Treadplate (see below)</p>	
<p>Sheet Thicknesses from 0.5 to 3mm in alloys 1050, 5251, 3103, 6082 & 4015.</p>	
<p>Plate & Sheet Cutting Aalco, together with sister companies and approved sub-contractors, provides a full range of cutting services including guillotine, plate sawing, water-jet and laser as well as coil processing.</p>	
<p>Coil, Strip & Blanks Using sister companies and approved sub-contractors Aalco provides full range of coil processing services.</p>	
<p>Treadplate, Patterned Sheet & Painted Sheet Wide choice including: 5-Bar, Aalco TripleGrip, Stucco, etc. Also White Painted Sheet.</p>	
<p>Shate Aalco holds the largest UK stock of aluminium shate, thicknesses 4 to 8mm in alloys 6082, 1050, 5251 & 5083.</p>	
<p>Finstock Aalco holds 150mm I/D coils in Alloy 8006 - Temper 0 (Soft) The material is stocked in both plain finish and with both sides coated in Gold Epoxy Phenolic. A range of widths are available in ten thicknesses 0.10mm to 0.30mm. Special widths and thicknesses are also available to customer requirements.</p>	
<p>Transition Joint (For welding aluminium to steel) Explosively Bonded Sandwich with 3 layers – Al Alloy 5083/Pure Al (1050A)/Steel. Width 25mm/Height 35mm/3.8 metre lengths. All stock Lloyds Register of Shipping Approved.</p>	

Full detail of all product ranges, alloys and sizes can be found in the Aalco Stocklist available **FREE** from your local Service Centres as well as on the website.



The old BS 1470 standard has been replaced by nine EN standards:

Standard	Scope
EN 485-1	Technical conditions for inspection and delivery
EN 485-2	Mechanical Properties
EN 485-3	Tolerances for HOT Rolled Material
EN 485-4	Tolerances for COLD Rolled material
EN 515	Temper Designations
EN 573-1	Numerical alloy designation system
EN 573-2	Chemical symbol designation system
EN 573-3	Chemical Compositions
EN 573-4	Product forms in different alloys

For those familiar with the old BS 1470 it is useful to highlight where the new EN standards differ:

- Chemical Compositions – No Change.
- Alloy Numbering System – No Change.
- Temper Designations for Heat Treatable Alloys – A new wider range of special tempers having up to four digits after the T have been introduced for non-standard applications (e.g. T6151).
- Temper Designations for Non Heat Treatable Alloys – No change to existing tempers but a more comprehensive definition of how tempers are achieved. Soft (O) temper is now classified H111 and an intermediate temper H112 is introduced. For alloy 5251 tempers are now shown as H32/H34/H36/H38 (equivalent to H22/H24, etc). H19/H22 & H24 are now shown separately.
- Mechanical Properties – Similar but not identical. Also, 0.2% Proof Stress must now be quoted on test certificates.
- Thickness Tolerances – Considerably tighter for alloys 1050A & 3103. To reflect manufacturing difficulty the tolerances for alloys 5251, 5083 & 6082 are now wider than this, although still a little tighter than in BS 1470.
- Length & Width Tolerances – These tend to be tighter and are now all on the plus side (i.e. minus zero).
- Flatness Tolerances – These are considerably tighter.

Chemical Composition

Please refer to the datasheet entitled **Aluminium Specifications**.

Mechanical Properties

Please refer to the datasheet entitled **Aluminium Specifications**.

Flatness Tolerances

Product	Thickness	Max Deviation over a 2500mm length	Max Deviation over a 1250mm width
Cold Rolled	0.5 to 3.0	10.0mm	5.0mm
	3.0 to 6.0	7.5mm	3.75m
Hot Rolled	6.0 to 200	5.0mm	2.5mm

Alloy Groups

Alloy Group	Main Alloying Element	Common Alloys	Previous Name
1000 Series	Pure	1050 / 1200	1B/1C
2000 Series	Copper	2014	H15
3000 Series	Manganese	3103	N3
4000 Series	Silicon	Alclad 4343/4015	N21
5000 Series	Magnesium	5251/5083	N4/N8
6000 Series	Magnesium Silicon	6063/6082	H9/H30
7000 Series	Zinc Magnesium Copper	7020/7075	H17
8000 Series	Others	8011	

Length Tolerances

Thickness (mm)	Hot Rolled EN 485-3	Cold Rolled EN 485-4
	Minus 0mm	Minus 0mm
	Plus:	Plus:
0.2 to 3.0	8.0mm	6.0mm
3.0 to 6.0	8.0mm	8.0mm
6.0 to 12.0	10.0mm	10.0mm
12.0 to 50.0	12.0mm	-
Over 50.0	14.0mm	-

Applies to lengths 2001mm to 3000mm

Width Tolerances

Thickness (mm)	Hot Rolled EN 485-3	Cold Rolled EN 485-4
	Minus 0mm	Minus 0mm
	Plus:	Plus:
0.2 to 3.0	-	3.0mm
3.1 to 6.0	7.0mm	4.0mm
6.1 to 12.0	7.0mm	5.0mm
12.1 to 50.0	8.0mm	-
51.0 to 200	8.0mm	-
201 to 400	12.0mm	

Applies to widths 1001mm to 2000mm for hot rolled and 501mm to 1250mm for cold rolled. For 1500mm wide cold rolled the tolerances are plus 4mm, 5mm & 5mm.

Thickness Tolerances – Hot Rolled

Thickness (mm)	Tolerance (+ or –) in mm for given width in mm	
	1250	1500
2.5 to 4.0	0.28	0.28
4.1 to 5.0	0.30	0.30
5.1 to 6.0	0.32	0.32
6.1 to 8.0	0.35	0.40
8.1 to 10.0	0.45	0.50
10.1 to 15.0	0.50	0.60
15.1 to 20	0.60	0.70
21 to 30	0.65	0.75
31 to 40	0.75	0.85
41 to 50	0.90	1.0
51 to 60	1.1	1.2
61 to 80	1.4	1.5
81 to 100	1.7	1.8
101 to 150	2.1	2.2
151 to 220	2.5	2.6
221 to 350	2.8	2.9
351 to 400	3.5	3.7

Thickness Tolerances – Cold Rolled

Note that for thickness tolerances of cold rolled material the alloys are split into two groups:

- Group I – 1000 series, 3000 series, 4006, 4007, 5005, 5050, 8011A
- Group II – 2000 series, 6000 series, 7000 series, 3004, 5040, 5049, 5251, 5052, 5154A, 5454, 5754, 5182, 5083, 5086

Thickness (mm)	Tolerance on thickness (+ or –) in mm					
	1000mm Wide		1250mm Wide		1500mm Wide	
	Group I	Group II	Group I	Group II	Group I	Group II
0.20 to 0.40	0.02	0.03	0.04	0.05	0.05	0.06
0.41 to 0.50	0.03	0.03	0.04	0.05	0.05	0.06
0.51 to 0.6	0.03	0.04	0.05	0.06	0.06	0.07
0.61 to 0.8	0.03	0.04	0.06	0.07	0.07	0.08
0.81 to 1.0	0.04	0.05	0.06	0.08	0.08	0.09
1.01 to 1,20	0.04	0.05	0.07	0.09	0.09	0.10
1.21 to 1.50	0.05	0.07	0.09	0.11	0.10	0.12
1.51 to 1.80	0.06	0.08	0.10	0.12	0.11	0.13
1.81 to 2.0	0.06	0.09	0.11	0.13	0.12	0.14
2.1 to 2.5	0.07	0.10	0.12	0.14	0.13	0.15
2.6 to 3.0	0.08	0.11	0.13	0.15	0.15	0.17
3.1 to 3.5	0.10	0.12	0.15	0.17	0.17	0.19
3.6 to 4.0	0.15		0.20		0.22	
4.1 to 5.0	0.18		0.22		0.24	
5.1 to 6.0	0.20		0.24		0.25	
6.1 to 8.0	0.24		0.30		0.31	
8.1 to 10.0	0.27		0.33		0.36	
10.1 to 12.0	0.32		0.38		0.40	
12.1 to 15.0	0.36		0.42		0.43	
15.1 to 20	0.38		0.44		0.46	
21 to 25	0.40		0.46		0.48	
26 to 30	0.45		0.50		0.53	
31 to 40	0.50		0.55		0.58	
41 to 50	0.55		0.60		0.63	

When measuring thickness a zone 10mm wide from the edges of the product shall be disregarded.

The Core Product Ranges are:

Round Bar

1/4" to 16" diameter in three machining alloys:

~ 6082T6 - Machines well and, with chip-breakers, produced swarf in short tight coils.

~ 2011T3/T6 – Often referred to as FMA (Free Machining Alloy) this is produced specially for use on high speed automatics lathes. Offers exceptional machinability and forms fine chips which are easily removed.

Used particularly for components with complex, detailed or extensive machining.

Can sometimes replace free machining brass without tool changes.

~ 6262T9 – May be used in place of 2011 in applications requiring higher corrosion resistance and better anodising response. Has excellent machinability and surface finishing characteristics.

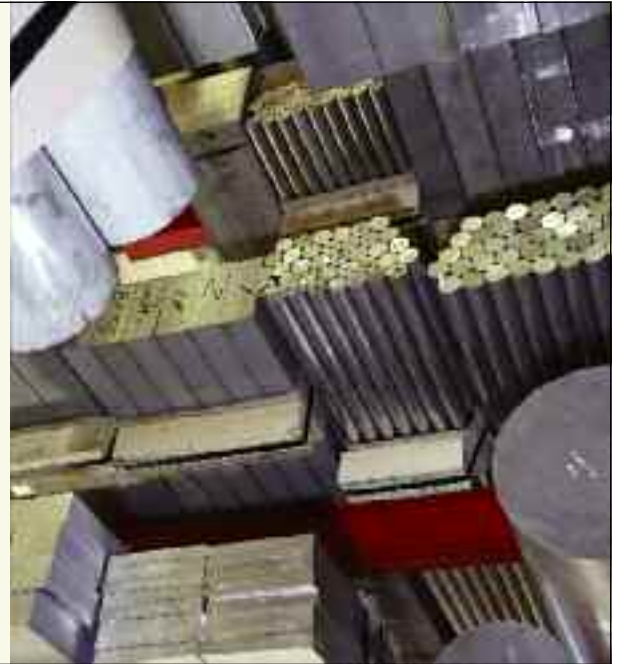

Flat Bar

3/8" x 1/4" to 6" x 1" in alloys 6082T6 and 6063A-T6

Square Bar

1/4" to 4" in alloy 6082T6

Tube & Box Section

In alloys 6082T6 & 6063T6:

~ Round from 3/8" O/D x 16swg to 6 1/2" O/D x 1/4" wall

~ Square 1/2" x 16swg to 4" x 1/4" wall

~ Rectangular from 1 1/2" x 3/4" x 16swg to 6" x 3" x 3/8" wall

Scaffold Tube

1 29/32" O/D x 7swg – drift tested to BS 1139

Tee

3/4" x 3/4" x 1/8" to 6" x 3" x 3/8" in alloys 6082T6 & 6063T6



Angle & Channel

In alloys 6082T6 & 6063T6:

- ~ Equal Angle from 1/2" x 1/2" x 1/16" to 6" x 6" x 1/2"
- ~ Unequal Angle from 1/4" x 1/2" x 1/16" to 6" x 3" x 3/8"
- ~ Channel (equal and unequal) from 3/4" x 1/2" to 8" x 3"



Road Transport Sections

A full range of bearers/runners, floor planks, side raves & guards, corner pillars, cant rails, top hats, zeds, mouldings, kick strips, curtain pole and associated products.



Bespoke Sections

Aalco is the UK's leading supplier of bespoke extrusions, providing customers across every sector of UK every industry with a huge range of sections cut and finished to their individual specifications. Sourcing expertise, purchasing power, in-depth knowledge of international supply sources plus relationships with all the major quality extruders in the world combine to ensure optimum solutions, on time and at competitive prices.



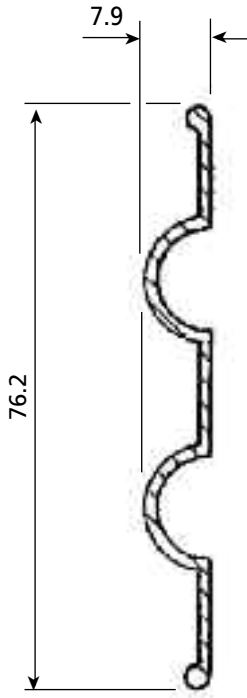

Wt. 0.432 kg/m

M101

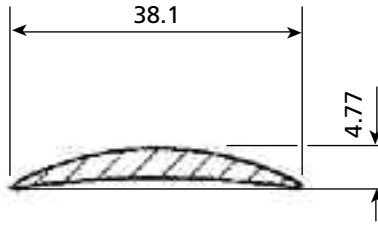

Wt. 0.267 kg/m

M102

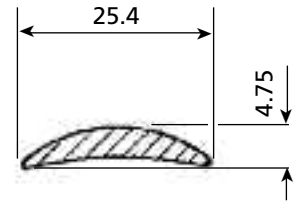

Wt. 0.196 kg/m

M103

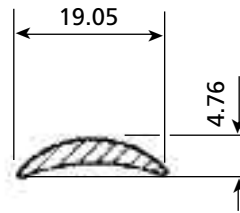

Wt. 0.144 kg/m

M104

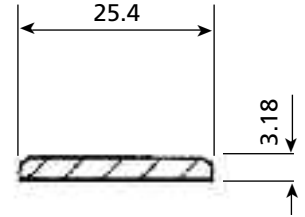

Wt. 0.206 kg/m

M105

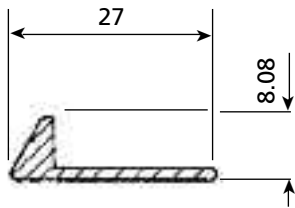

Wt. 0.140 kg/m

M106

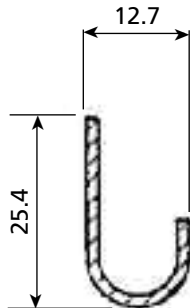

Wt. 0.189 kg/m

M107

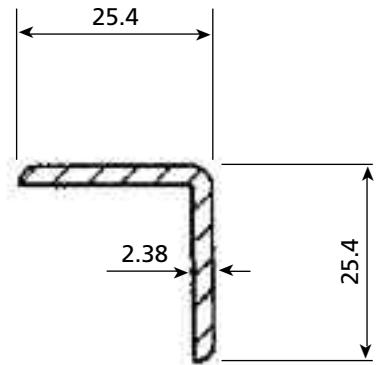

Wt. 0.30 kg/m

M109

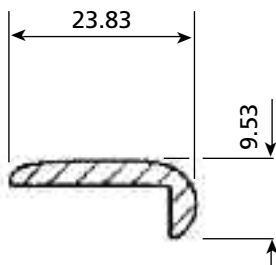

Wt. 0.217 kg/m

M116

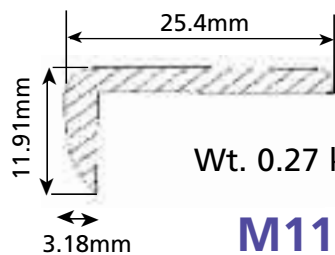

Wt. 0.27 kg/m

M117

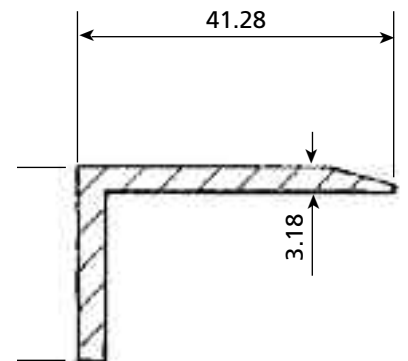

Wt. 0.519 kg/m

M118

These are just a selection of the many shapes available and may not be shown at actual size.

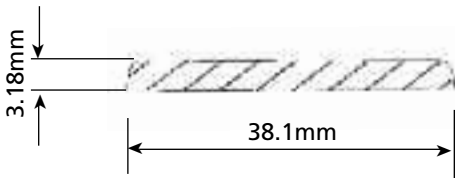

Wt. 0.33 kg/m

M150

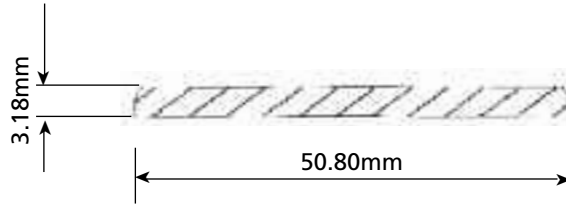

Wt. 0.44 kg/m

M200

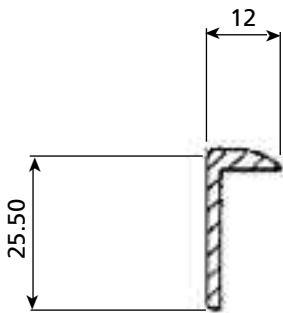

Wt. 0.23 kg/m

M306

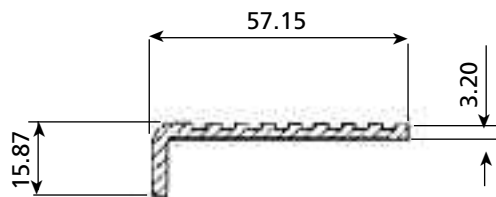

Wt. 0.50 kg/m

FH3

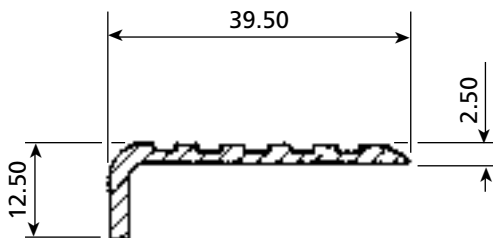

Wt. 0.272 kg/m

FH70

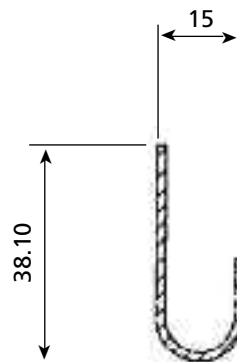

Wt. 0.28 kg/m

MJ52/GUT1504

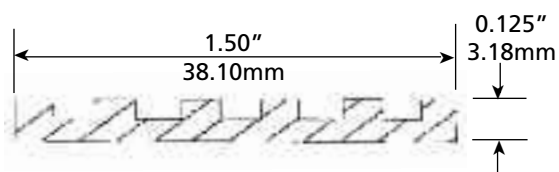

Wt. 0.25 kg/m

FS4

These are just a selection of the many shapes available and may not be shown at actual size.

The old BS 1474 – 1987 standard has been replaced by a number of EN standards of which the most important are:

Standard	Scope
EN 755	Extruded products
EN 755-1	Technical conditions for inspection and delivery
EN 755-2	Mechanical properties
EN 755-3	Tolerances for round bars
EN 755-4	Tolerances for square bars
EN 755-5	Tolerances for rectangular bars
EN 755-6	Tolerances for hexagon bars
EN 755-9	Tolerances on other profiles/shapes
EN 12020	Extruded precision profiles in alloys 6060 & 6063
EN 515	Temper Designations
EN 573-1	Numerical alloy designation system
EN 573-2	Chemical symbol designation system
EN 573-3	Chemical Compositions
EN 573-4	Product forms in different alloys

For those familiar with the old BS 1474 it is useful to highlight where the new EN standards differ:

- Chemical Compositions – No Change.
- Alloy Numbering System – No Change.
- Temper Designations for Heat Treatable Alloys – A new wider range of special tempers having up to four digits after the T have been introduced for non-standard applications (e.g. T6151).
- Temper Designations for Non Heat Treatable Alloys – No change to existing tempers but a more comprehensive definition of how tempers are achieved. Soft (O) temper is now classified H111 and an intermediate temper H112 is introduced. For alloy 5251 tempers are now shown as H32/H34/H36/H38 (equivalent to H22/H24, etc). H19/H22 & H24 are now shown separately.



Alloy Groups

Alloy Group	Main Alloying Element	Common Alloys	Previous Name
1000 Series	Pure	1050 / 1200	1B/1C
2000 Series	Copper	2014	H15
3000 Series	Manganese	3103	N3
4000 Series	Silicon	Alclad 4343/4015	N21
5000 Series	Magnesium	5251/5083	N4/N8
6000 Series	Magnesium Silicon	6063/6082	H9/H30
7000 Series	Zinc Magnesium Copper	7020/7075	H17
8000 Series	Others	8011	

Note that for the purposes of tolerances the alloys are split into two groups:

- **Group I** – 1000 series, 3000 series, 5005, 6101, 6005, 6106, 6060, 6063, 6463
- **Group II** – 2000 series, 7000 series, 5051, 5251, 5052, 5154, 5454, 5754, 5083, 5086



Diameter Tolerances – Round Bars

Diameter (mm)	Tolerances in mm Plus or Minus	
	Group I	Group II
10 to 18	0.22	0.30
19 to 25	0.25	0.35
26 to 40	0.30	0.40
41 to 50	0.35	0.45
51 to 65	0.40	0.50
66 to 80	0.45	0.70
81 to 100	0.55	0.90
101 to 120	0.65	1.00
121 to 150	0.8	1.2
151 to 180	1.0	1.4
181 to 220	1.15	1.7
221 to 270	1.3	2.0
271 to 320	1.6	2.5

Dimensional Tolerances – Hexagon Bars

Width Across Flats (mm)	Tolerances in mm Plus or Minus	
	Group I	Group II
10 to 18	0.22	0.30
19 to 25	0.25	0.35
26 to 40	0.30	0.40
41 to 50	0.35	0.45
51 to 65	0.40	0.50
66 to 80	0.50	0.70
81 to 100	0.55	0.90
101 to 120	0.65	1.0
121 to 150	0.80	1.2
151 to 180	1.0	1.4
181 to 220	1.15	1.7

Dimensional Tolerances – Square Bars

Width across Flats (mm)	Tolerances in mm Plus or Minus	
	Group I	Group II
10 to 18	0.22	0.30
19 to 25	0.25	0.35
26 to 40	0.30	0.40
41 to 50	0.35	0.45
51 to 65	0.40	0.50
66 to 80	0.40	0.70
81 to 100	0.55	0.90
101 to 120	0.65	1.00
121 to 150	0.80	1.20
151 to 180	1.0	1.4
181 to 220	1.15	1.70

Max Corner Radii – Square Bars

Width Across Flats (mm)	Tolerances in mm Plus or Minus	
	Group I	Group II
10 to 25	1.0	1.5
26 to 50	1.5	2.0
51 to 80	2.0	3.0
81 to 120	2.5	3.0
121 to 180	2.5	4.0
181 to 220	3.5	5.0

Squareness Tolerances – Square Bars

Width Across Flats (mm)	Max Deviation From Square (mm)
10 to 100	0.01 x Width Across Flats
101 to 180	1.0
181 to 220	1.5



Width Tolerance – Rectangular Bars

Width Across Flats (mm)	Tolerances in mm Plus or Minus	
	Group I	Group II
10 to 18	0.25	0.35
19 to 30	0.30	0.40
31 to 50	0.40	0.50
51 to 80	0.60	0.70
81 to 120	0.80	1.0
121 to 180	1.0	1.4
181 to 240	1.4	1.8
241 to 350	1.8	2.2
351 to 450	2.2	2.8
451 to 600	3.0	3.5

Squareness Tolerances – Rectangular Bars

Width Across Flats (mm)	Max Deviation From Square (mm)
2 to 10	0.1
11 to 100	0.01 x Width Across Flats
101 to 180	1.0
181 to 240	1.5



Thickness Tolerances for Rectangular Bars – Group I

Width Across Flats (mm)	Thickness Tolerances in mm Plus or Minus for given thickness range in m m								
	2-6	6.1-10	10.1-18	19-30	31-50	51-80	81-120	121-180	181-240
10 to 18	0.20	0.25	0.25	-	-	-	-	-	-
19 to 30	0.20	0.25	0.30	0.3	-	-	-	-	-
31 to 50	0.25	0.25	0.30	0.35	0.4	-	-	-	-
51 to 80	0.25	0.30	0.35	0.40	0.5	0.6	-	-	-
81 to 120	0.30	0.35	0.40	0.45	0.6	0.7	0.8	-	-
121 to 180	0.40	0.45	0.50	0.55	0.6	0.7	0.9	1.0	-
181 to 240	-	0.55	0.60	0.65	0.7	0.8	1.0	1.2	1.4
241 to 350	-	0.65	0.70	0.75	0.8	0.9	1.1	1.3	1.5
351 to 450	-	-	0.80	0.85	0.9	1.0	1.2	1.4	1.6
451 to 600	-	-	-	-	0.9	1.0	1.4	-	-

Thickness Tolerances for Rectangular Bars – Group II

Width Across Flats (mm)	Thickness Tolerances in mm Plus or Minus for given thickness range in m m								
	2-6	6.1-10	10.1-18	19-30	31-50	51-80	81-120	121-180	181-240
10 to 18	0.25	0.30	0.35	-	-	-	-	-	-
19 to 30	0.25	0.30	0.40	0.4	-	-	-	-	-
31 to 50	0.30	0.30	0.40	0.5	0.5	-	-	-	-
51 to 80	0.30	0.35	0.45	0.6	0.7	0.7	-	-	-
81 to 120	0.35	0.40	0.50	0.6	0.7	0.8	1.0	-	-
121 to 180	0.45	0.50	0.55	0.7	0.8	1.0	1.1	1.4	-
181 to 240	-	0.60	0.65	0.7	0.9	1.1	1.3	1.6	1.8
241 to 350	-	0.70	0.75	0.8	0.9	1.2	1.4	1.7	1.9
351 to 450	-	-	0.90	1.0	1.1	1.4	1.8	2.1	2.3
451 to 600	-	-	-	-	1.2	1.4	1.8	-	-

Diameter Tolerances for Seamless & Porthole Round Tube

Diameter (mm) OD or ID	Max Deviation of Mean Diameter	Max Deviation at Any Point mm		
	+ or - mm	Not Annealed or Heat Treated	Heat-Treated	Annealed
8 to 18	0.25	0.4	0.6	1.5
19 to 30	0.30	0.5	0.7	1.8
31 to 50	0.35	0.6	0.9	2.2
51 to 80	0.40	0.7	1.1	2.6
81 to 120	0.60	0.9	1.4	3.6
121 to 200	0.90	1.4	2.0	5.0
201 to 350	1.4	1.9	3.0	7.6
351 to 450	1.9	2.8	4.0	10.0

Wall Thickness Tolerances for SEAMLESS Round Tube

Wall Thickness (mm)	Tolerance Measured at Any Point (Plus or Minus %)
0.5 to 2.0	10
2.1 to 3.0	9
Over 3.0	8

Tolerances on Width, Depth or Width Across Flats for Seamless & Porthole Tube

Width, Depth or Width Across Flats mm	Tolerances in mm Plus or Minus for given Circumscribing Circle Dimension in mm							
	Up to 100mm		101 to 200mm		201 to 300mm		301 to 350mm	
	Grp I	Grp II	Grp I	Grp II	Grp I	Grp II	Grp I	Grp II
Up to 10	0.25	0.4	0.3	0.5	0.35	0.55	0.4	0.6
11 to 25	0.30	0.5	0.4	0.7	0.5	0.8	0.6	0.9
26 to 50	0.50	0.8	0.6	0.9	0.8	1.0	0.9	1.2
51 to 100	0.70	1.0	0.9	1.2	1.1	1.3	1.3	1.6
101 to 150	-	-	1.1	1.5	1.3	1.7	1.5	1.8
151 to 200	-	-	1.3	1.9	1.5	2.2	1.8	2.4
201 to 300	-	-	-	-	1.7	2.5	2.1	2.8
301 to 350	-	-	-	-	-	-	2.8	3.5

Tolerances on Wall Thickness for SEAMLESS Tube – Other Than Round Tube

Wall Thickness (mm)	Tolerances in mm Plus or Minus for given Circumscribing Circle Dimension in mm					
	Up to 100mm		101 to 300mm		301 to 350mm	
	Grp I	Grp II	Grp I	Grp II	Grp I	Grp II
0.5 to 1.5	0.25	0.35	0.35	0.50	-	-
1.51 to 3.0	0.30	0.45	0.50	0.65	0.75	0.9
3.1 to 6.0	0.50	0.6	0.75	0.90	1.0	1.2
6.1 to 10	0.75	1.0	1.0	1.3	1.2	1.5
11 to 15	1.0	1.3	1.2	1.7	1.5	1.9
16 to 20	1.5	1.9	1.9	2.2	2.0	2.5
21 to 30	1.9	2.2	2.2	2.7	2.5	3.1
31 to 40	-	-	2.5	-	2.7	-

Wall Thickness Tolerances for PORTHOLE Round Tube

Wall Thickness (mm)	Tolerance Measured at Any Point (Plus or Minus %)
0.5 to 2.0	7
2.1 to 3.0	6
Over 3.0	5

Tolerances on Wall Thickness for PORTHOLE Tube – Other Than Round Tube

Wall Thickness (mm)	Tolerances in mm Plus or Minus for given Circumscribing Circle Dimension in mm					
	Up to 100mm		101 to 300mm		301 to 350mm	
	Grp I	Grp II	Grp I	Grp II	Grp I	Grp II
0.5 to 1.5	0.20	0.30	0.3	0.4	-	-
1.51 to 3.0	0.25	0.35	0.4	0.5	0.6	0.7
3.1 to 6.0	0.40	0.55	0.6	0.7	0.8	0.9
6.1 to 10	0.60	0.75	0.8	1.0	1.0	1.2
11 to 15	0.80	1.0	1.0	1.3	1.2	1.5
16 to 20	1.2	1.5	1.5	1.8	1.7	3.0
21 to 30	1.5	1.8	1.8	2.2	2.0	3.5
31 to 40	-	-	2.0	2.5	2.0	3.0

- In this table alloys covered in the columns headed II are: 5051, 5251, 5052, 6012, 6018, 6351, 6061, 6262, 6081, 6082, 7 Series
- Other alloys are covered in the columns headed I



Aalco stocks all of the commonly required forms of copper and its alloys including sheet, plate, machining rod & hollow rod, flat bar, hexagon bar and tube. In addition to a comprehensive range of standard sizes, Aalco Service Centres stock industry specific items and customer specials.

Aalco also provides a complete range of processing services including bar, tube & pipe cutting and plate processing.

The Core Product Ranges are:

Brass

Free Machining rod and hexagon
Riveting Brass rod
Dezincification Resistant (DZR) brass rod
High Tensile Brass rod
Naval Brass rod and plate
Angle, Flat Bar & Square Bar
Tube
Half Hard, Polished and Spinning Quality sheet



Copper

Half Hard and Spinning Quality sheet
Plate
High Conductivity flat bar
Rod
Tube, including coiled tube for refrigeration and air conditioning



Bronze

Phosphor Bronze rod PB102
Bearing Bronze rod and hollows SAE660,
Aluminium Bronze rod CA104
Phosphor Bronze plate and sheet
Aluminium Bronze rod and hexagon DEFSTAN833



Full detail of all product ranges, alloys and sizes can be found in the Aalco Stocklist available **FREE** from your local Service Centre as well as on the website www.aalco.co.uk



Copper is the oldest metal used by man. Its use dates back to prehistoric times. Copper has been mined for more than 10,000 years with a Copper pendant found in current day Iraq being dated to 8700BC. By 5000BC Copper was being smelted from simple Copper Oxides.

Copper is found as native metal and in minerals cuprite, malachite, azurite, chalcopyrite and bornite. It is also often a by-product of silver production. Sulphides, oxides and carbonates are the most important ores.

Copper and Copper alloys are some of the most versatile engineering materials available. The combination of physical properties such as strength, conductivity, corrosion resistance, machinability and ductility make copper suitable for a wide range of applications. These properties can be further enhanced with variations in composition and manufacturing methods.



The largest end use for Copper is in the building industry. Within the building industry the use of copper based materials is broad. Construction industry related applications for copper include:

- Roofing
- Cladding
- Rainwater systems
- Heating systems
- Water pipes and fittings
- Oil and gas lines
- Electrical wiring

The building industry is the largest single consumer of copper alloys. The following list is a breakdown of copper consumption by industry on an annual basis:

- Building industry – 47%
- Electronic products – 23%
- Transportation – 10%
- Consumer products – 11%
- Industrial machinery – 9%

There are around 370 commercial compositions for copper alloys. The most common grade tends to be C106/ CW024A - the standard water tube grade of copper.

World consumption of copper and copper alloys now exceeds 18 million tonnes per annum.

Applications

Copper and copper alloys can be used in an extraordinary range of applications. Some of these applications include:

- Power transmission lines
- Architectural applications
- Cooking utensils
- Spark plugs
- Electrical wiring, cables and busbars
- High conductivity wires
- Electrodes
- Heat exchangers
- Refrigeration tubing
- Plumbing
- Water-cooled copper crucibles

Structure

Copper has a face centred cubic crystal structure. It is yellowish red in physical appearance and when polished develops a bright metallic lustre.

Key Properties of Copper Alloys

Copper is a tough, ductile and malleable material. These properties make copper extremely suitable for tube forming, wire drawing, spinning and deep drawing. The other key properties exhibited by copper and its alloys include:

- Excellent heat conductivity
- Excellent electrical conductivity
- Good corrosion resistance
- Good biofouling resistance
- Good machinability
- Retention of mechanical and electrical properties at cryogenic temperatures
- Non-magnetic

Other Properties

- Copper and Copper alloys have a peculiar smell and disagreeable taste. These may be transferred by contact and therefore Copper should be kept clear of foodstuffs.
- Most commercially used metals have a metallic white colour. Copper is a yellowish red.

Melting Point

The melting point for pure copper is 1083°C.



Electrical Conductivity

The electrical conductivity of copper is second only to silver. The conductivity of copper is 97% that of silver. Due to its much lower cost and greater abundance, copper has traditionally been the standard material used for electricity transmission applications.

However, weight considerations mean that a large proportion of overhead high voltage power lines now use aluminium rather than copper. By weight, the conductivity of aluminium is around twice that of copper. The aluminium alloys used do have a low strength and need to be reinforced with a galvanised or aluminium coated high tensile steel wire in each strand.

Although additions of other elements will improve properties like strength, there will be some loss in electrical conductivity. As an example a 1% addition of cadmium can increase strength by 50%. However, this will result in a corresponding decrease in electrical conductivity of 15%.

Corrosion Resistance

All Copper alloys resist corrosion by fresh water and steam. In most rural, marine and industrial atmospheres Copper alloys also resistant to corrosion. Copper is resistant to saline solutions, soils, non-oxidising minerals, organic acids and caustic solutions. Moist ammonia, halogens, sulphides, solutions containing ammonia ions and oxidising acids, like nitric acid, will attack Copper. Copper alloys also have poor resistance to inorganic acids.

The corrosion resistance of Copper alloys comes from the formation of adherent films on the material surface. These films are relatively impervious to corrosion therefore protecting the base metal from further attack.

Copper Nickel alloys, Aluminium Brass, and Aluminium Bronzes demonstrate superior resistance to saltwater corrosion.

Surface Oxidation of Copper

Most Copper alloys will develop a blue-green patina when exposed to the elements outdoors. Typical of this is the colour of the Copper Statue of Liberty in New York. Some Copper alloys will darken after prolonged exposure to the elements and take on a brown to black colour.

Lacquer coatings can be used to protect the surface and retain the original alloy colour. An acrylic coating with benzotriazole as an additive will last several years under most outdoor, abrasion-free conditions.

Yield Strength

The yield point for Copper alloys is not sharply defined. As a result it tends to be reported as either a 0.5% extension under load or as 0.2% offset.

Most commonly the 0.5% extension yield strength of annealed material registers as approximately one-third the tensile strength. Hardening by cold working means the material becomes less ductile, and yield strength approaches the tensile strength.



Joining

Commonly employed processes such as brazing, welding and soldering can be used to join most copper alloys. Soldering is often used for electrical connections. High Lead content alloys are unsuitable for welding.

Copper and Copper alloys can also be joined using mechanical means such as rivets and screws.

Hot and Cold Working

Although able to be work hardened, Copper and Copper alloys can be both hot and cold worked. Ductility can be restored by annealing. This can be done either by a specific annealing process or by incidental annealing through welding or brazing procedures.

Temper

Copper alloys can be specified according to temper levels. The temper is imparted by cold working and subsequent degrees of annealing.

Typical tempers for Copper alloys are

- Soft
- Half-hard
- Hard, spring
- Extra-spring.

Yield strength of a hard-temper Copper alloy is approximately two-thirds of the materials' tensile strength.

Copper Designations

Designation systems for Copper are not specifications, but methods for identifying chemical compositions. Property requirements are covered in EN, ASTM, government and military standards for each composition.

The alloy designation system used in the UK and across Europe uses a 6 character alpha-numeric series.

The 1st letter is C for copper-based material

The second letter indicates the product form:

- B = Ingot for re-melting to produce cast products
- C = Cast products
- F = Filler materials for brazing and welding
- M = Master Alloys
- R = Refined unwrought Copper
- S = Scrap
- W = Wrought products
- X = Non-standard materials

There is then a 3 digit number between 001 and 999 with the numbers being in groups as shown in the table below

There is then a letter indicating the copper or alloy grouping, also shown in the table

Number Series	Letters	Materials
001 - 099	A or B	Copper
100 - 199	C or D	Copper Alloys, Min. 95% Cu
200 - 299	E or F	Copper Alloys, < 95% Cu
300 - 349	G	Copper-Aluminium Alloys
350 - 399	H	Copper-Nickel Alloys
400 - 449	J	Copper-Nickel-Zinc Alloys
450 - 499	K	Copper-Tin Alloys
500 - 599	L or M	Copper-Zinc Alloys – Binary
600 - 699	N or P	Copper-Zinc-Lead Alloys
700 - 799	R or S	Copper-Zinc Alloys – Complex



UNS Designations

The method for designating Copper alloys is an expansion upon the system developed by the U.S. copper and brass industry using five digits preceded by the letter C.

UNS Numbers	Types	Alloy Names
C10000-C19999	Wrought	Coppers, High-Copper Alloys
C20000-C49999	Wrought	Brasses
C50000-C59999	Wrought	Phosphor Bronzes
C60600-C64200	Wrought	Aluminium Bronzes
C64700-C66100	Wrought	Silicon Bronzes
C66400-C69800	Wrought	Brasses
C70000-C79999	Wrought	Copper nickels, nickel silvers
C80000-C82800	Cast	Coppers, High-Copper Alloys
C83300-C85800	Cast	Brasses
C86100-C86800	Cast	Manganese Bronzes
C87200-C87900	Cast	Silicon Bronzes and Brasses
C90200-C94800	Cast	Tin Bronzes
C95200-C95800	Cast	Aluminium Bronzes
C96200-C97800	Cast	Copper Nickels, Nickel Silvers
C98200-C98800	Cast	Leaded Copper
C99300-C99750	Cast	Special Alloys

Cast Copper Alloys

The nature of the casting process means that most cast Copper alloys have a greater range of alloying elements than wrought alloys.

Wrought Copper Alloys

Wrought copper alloys are produced using a variety of different production methods. These methods include processes such as annealing, cold working, hardening by heat treatments or stress relieving.

Copper Alloy Families

Within the wrought and cast categories for Copper alloys, the compositions can be divided into the following main families:

- Pure Coppers
- High Copper Alloys
- Brasses
- Bronzes

Coppers

The Pure Coppers have a Copper content of 99.3% or higher.

High Copper Alloys

Wrought high Copper alloys have Copper contents of less than 99.3% but more than 95% but don't fall into another Copper alloy group. Cast high Copper alloys have Copper contents in excess of 94%. Silver may be added to impart special properties.

Brasses

Brasses contain Zinc as the principal alloying element. Other alloying elements may also be present to impart advantageous properties. These elements include Iron, Aluminium, Nickel and Silicon.

Brasses are most commonly characterised by their free machining grades by which machining standards are set for all other metals.

Brasses can also have high corrosion resistance and high tensile strength. Some brasses are also suited to hot forging.

Brass Additives

Adding Lead to a brass composition can result in a brass with the ability to be rapidly machined. It will also produce less tool wear. Adding Aluminium, Iron and Manganese to brass improves strength. Silicon additions improve wear resistance.

Brasses are divided into two classes and three families.

Brass Classes

Brasses are divided into two classes. These are:

- The alpha alloys, with less than 37% Zinc. These alloys are ductile and can be cold worked.
- The alpha/beta or duplex alloys with 37-45% Zinc. These alloys have limited cold ductility and are typically harder and stronger.

Brass Families

There are three main families of wrought alloy brasses:

- Copper-Zinc alloys
- Copper-Zinc-Lead alloys (Leaded brasses)
- Copper-Zinc-Tin alloys (Tin brasses)

Cast brass alloys can be broken into four main families:

- Copper-Tin-Zinc alloys
- Manganese Bronze (high strength brasses) and Leaded Manganese Bronze (high tensile brasses)
- Copper-Zinc-Silicon alloys (Silicon brasses and bronzes)
- Cast Copper-Bismuth and Copper-Bismuth-Selenium alloys.

Bronzes

The term bronze originally described alloys with Tin as the only or principal alloying element.

Modern day bronzes tend to be Copper alloys in which the major alloying element is not Nickel or Zinc.

Bronzes can be further broken down into four families for both wrought and cast alloys.

Bronze Families

The wrought bronze alloy families are:

- Copper-Tin-Phosphorus alloys (Phosphor Bronzes)
- Copper-Tin-Lead-Phosphorus alloys (Leaded Phosphor Bronzes)
- Copper-Aluminium alloys (Aluminium Bronzes)
- Copper-Silicon alloys (Silicon Bronzes)

The cast bronze alloy families are:

- Copper-Tin alloys (Tin Bronzes)
- Copper-Tin-Lead alloys (Leaded and high leaded Tin Bronzes)
- Copper-Tin-Nickel alloys (nickel-tin bronzes)
- Copper-Aluminium alloys (Aluminium Bronzes)

Other Alloy Groups

Copper-Nickel Alloys

As the name suggests, the principal alloying element is Nickel. They can contain other alloying elements or simply have Nickel alone.

Copper-Nickel-Zinc Alloys

These alloys are commonly known as “Nickel Silvers” due to the colour of the alloy. They contain Zinc and Nickel as the principal alloying elements and may also contain other alloying elements.

Leaded Coppers

Leaded Coppers are cast Copper alloys with 20% or more Lead added. They may also contain a small amount of Silver but have no Tin or Zinc. Due to the toxicity of Lead these are no longer in widespread use.

Special Alloys

When alloys have chemical compositions that do not fall into any of the other categories mentioned, they are grouped together as “special alloys”.

Free Machining Coppers

Free machining properties are imparted upon Copper alloys by the addition of Sulphur and Tellurium.

Recycling

Copper alloys are highly suited to recycling. Around 40% of the annual consumption of Copper alloys is derived from recycled Copper materials.

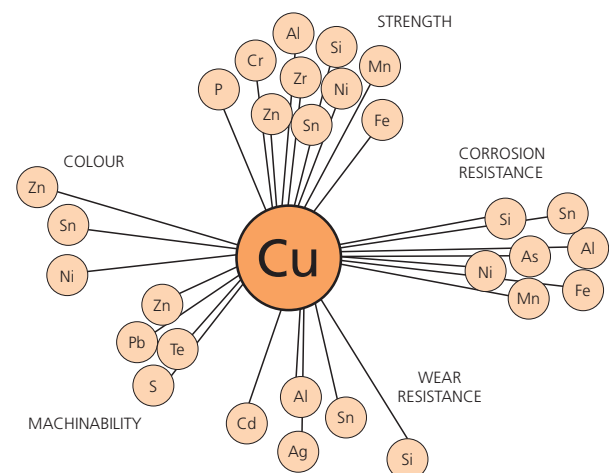

EN Standards for Copper and Copper Alloys		
EN Number	Title	Nearest Old BS Equivalent
Unwrought Products		
1976	Cast unwrought copper products	6017
1977	Copper drawing stock (wire rod)	6926
1978	Copper cathodes	6017
1981	Master alloys	-
1982	Ingots and castings	1400
Rolled Flat Products		
1172	Sheet and strip for building purposes	2870
1652	Plate, sheet, strip and circles for general purposes	2870, 2875
1653	Plate, sheet and circles for boilers, pressure vessels and hot water storage units	2870, 2875
1654	Strip for springs and connectors	2870
1758	Strip for lead frames	-
13148	Hot dip tinned strip	-
14436	Electrolytically tinned strip	-
Tubes		
1057	Seamless, round tubes for water and gas in sanitary and heating applications	2871 Pt1
12449	Seamless, round tubes for general purposes	2871 Pt 2
12450	Seamless, round capillary tubes	-
12451	Seamless, round tubes for heat exchangers	2871 Pt 3
12452	Rolled, finned, seamless tubes for heat exchangers	-
12735	Seamless round tubes for air conditioning and refrigeration	-
	Part 1: Tubes for piping systems	-
	Part 2: Tubes for equipment	-
13348	Seamless, round copper tubes for medical gases	-
13349	Pre-insulated copper tubes with solid covering	-
Rod/Bar, Wire, Profiles		
12163	Rod for general purposes	2874
12164	rod for free machining purposes	2874
12165	Wrought and unwrought forging stock	2872
12166	Wire for general purposes	2873
12167	Profiles and rectangular bar for general purposes	2874
12168	Hollow rod for free machining purposes	-
13347	Rod and wire for welding and braze welding	1453, 1845, 2901
Electrical Purposes		
13599	Copper plate, sheet and strip for electrical purposes	4608
13600	Seamless copper tubes for electrical purposes	1977
13601	Copper rod, bar and wire for general electrical purposes	1433, 1432, 4109
13602	Drawn round copper wire for the manufacture of electrical conductors	4109
13604	Products of high conductivity copper for electronic tubes, semiconductor devices and vacuum applications	3839
13605	Copper profiles for electrical purposes	-
60317-0-1	Enamelled copper wire	6811

Wrought Copper Alloys – Conversion of old BS into EN Material Designations

(These are arranged broadly in increasing order of alloying content)

Nearest Old BS Equivalent	EN Material Designation Symbol	Number	Nearest Old BS Equivalent	EN Material Designation Symbol	Number
Heat-treatable Alloys			Copper-zinc (Brass) – continued		
CB101	CuBe1.7	CW100C	CZ107	CuZn36	CW507L
-	CuBe2	CW101C	CZ108	CuZn37	CW508L
-	CuBe2Pb	CW102C	CZ109	CuZn40	CW509L
-	CuCo1Ni1Be	CW103C	Copper-zinc-lead Alloys (Leaded Brasses)		
C112	CuCo2Be	CW104C	CZ104	-	-
-	Cu/Ni2Be	CW110C	CZ124	CuZn36Pb3	CW603N
CC101	CuCr1	CW105C	CZ121Pb4	CuZn38Pb4	CW609N
CC102	CuCr1Zr	CW106C	CZ121Pb3	CuZn39Pb3	CW614N
C113	CuNi1P	CW108C	CZ122	CuZn40Pb2	CW617N
-	CuNi1Si	CW109C	CZ119	CuZn37Pb2	CW606N
-	CuNi2Si	CW111C	CZ131	CuZn37Pb2	CW606N
-	CuNi3Si1	CW112C	CZ120	CuZn38Pb2	CW608N
-	CuZr	CW120C	CZ128	CuZn38Pb2	CW608N
Non Heat-treatable Alloys – Free Machining			CZ120	CuZn39Pb2	CW612N
-	CuPb1P	CW113C	CZ128	CuZn39Pb2	CW612N
C109	CuTeP	CW118C	CZ118	CuZn35Pb1	CW600N
C111	CuSP	CW114C	CZ119	CuZn35Pb2	CW601N
Non Heat-treatable Alloys – Other			CZ131	CuZn35Pb2	CW601N
-	CuFe2P	CW107C	-	CuZn38Pb1	CW607N
-	CuSi1	CW115C	CZ123	CuZn39Pb0.5	CW610N
CS101	CuSi3Mn	CW116C	CZ137	CuZn39Pb0.5	CW610N
-	CuSn0.15	CW117C	CZ129	CuZn39Pb1	CW611N
-	CuZn0.5	CW119C	CZ132	CuZn36Pb2As	CW602N
C108	CuCd	-	-	CuZn39Pb2Sn	CW613N
-	CuCd0.7	CW130C	-	CuZn40Pb2Sn	CW619N
-	CuCd1.0	CW131C	-	CuZn39Pb3Sn	CW615N
Copper-tin (Phosphor Bronze)			-	CuZn40Pb1Al	CW616N
PB101	CuSn4	CW450K	-	CuZn40Pb2Al	CW618N
PB102	CuSn5	CW451K	-	CuZn41Pb1Al	CW620N
PB103	CuSn6	CW452K	-	CuZn42PbAl	CW621N
PB104	CuSn8	CW453K	-	CuZn43Pb1Al	CW622N
-	CuSn8P	CW459K	CZ130	CuZn43Pb2Al	CW624N
-	CuSn4Pb2P	CW455K	CZ130	CuZn43Pb2	CW623N
-	CuSn4Te1P	CW457K	-	CuZn37Pb0.5	CW604N
-	CuSn5Pb1	CW458K	-	CuZn37Pb1	CW605N
-	CuSn8PbP	CW460K	Copper-zinc Alloys (Corrosion Resistant Alloys)		
-	CuSn3Zn9	CW454K	CZ127	CuZn13Al1Ni1Si1	CW700R
-	CuSn4Pb4Zn4	CW456K	CZ110	CuZn20Al2As	CW702R
Copper-zinc (Brass)			CZ111	CuZn28Sn1As	CW706R
CZ125	CuZn5	CW500L	CZ126	CuZn30As	CW707R
CZ101	CuZn10	CW501L	CZ105	CuZn30As	CW707R
CZ102	CuZn15	CW502L	-	CuZn38AlFeNiPbSn	CW715R
CZ103	CuZn20	CW503L	-	CuZn38Sn1As	CW717R
-	CuZn28	CW504L	-	CuZn32Pb2AsFeSi	CW709R
CZ106	CuZn30	CW505L	CZ134	CuZn36Pb2Sn1	CW711R
-	CuZn33	CW506L	CZ112	CuZn36Sn1Pb	CW712R
			CZ113	-	-
			-	CuZn37Pb1Sn1	CW714R
			CZ133	CuZn39Sn1	CW719R

cont. – Wrought Copper Alloys – Conversion of old BS into EN Material Designations (These are arranged broadly in increasing order of alloying content)					
Nearest Old BS Equivalent	EN Material Designation		Nearest Old BS Equivalent	EN Material Designation	
	Symbol	Number		Symbol	Number
High Tensile Brasses			Copper-nickel		
-	CuZn23Al6Mn4Fe3Pb	CW704R	CN105	CuNi25	CW350H
CZ116	CuZn25Al5Fe2Mn2Pb	CW705R	CN101	-	-
-	CuZn35Ni3Mn2AlPb	CW710R	-	CuNi9Sn2	CW351H
CZ114	CuZn40Mn1Pb1AlFeSn	CW721R	CN102	CuNi10Fe1Mn	CW352H
CZ115	CuZn40Mn1Pb1FeSn	CW722R	CN103	-	-
-	CuZn31Si1	CW708R	CN104	-	-
CZ135	CuZn37Mn3Al2PbSi	CW713R	CN106	-	-
-	CuZn39Mn1AlPbSi	CW718R	CN108	CuNi30Fe2Mn2	CW353H
			CN107	CuNi30Mn1Fe	CW354H
Other Brasses			Copper-nickel-zinc (Nickel Silver)		
-	CuZn19Sn	CW701R	NS103	CuNi10Zn27	CW401J
-	CuZn23Al3Co	CW703R	NS104	CuNi12Zn24	CW403J
-	CuZn38Mn1Al	CW716R	NS111	CuNi12Zn25Pb1	CW404J
CZ136	CuZn40Mn1Pb1	CW720R	-	CuNi12Zn29	CW405J
-	CuZn40Mn2Fe1	CW723R	-	CuNi12Zn30Pb1	CW406J
Copper-aluminium (Aluminium Bronze)			NS105	-	-
-	CuAl5As	CW300G	NS112	-	-
CA101	-	-	NS113	CuNi18Zn19Pb1	CW408J
CA107	CuAl6Si2Fe	CW301G	NS106	CuNi18Zn20	CW409J
-	CuAl7Si2	CW302G	NS107	CuNi18Zn27	CW410J
CA106	CuAl8Fe3	CW303G	NS108	-	-
CA102	-	-	NS109	-	-
CA105	CuAl9Ni3Fe2	CW304G	-	CuNi7Zn39Pb3Mn2	CW400J
CA103	-	-	NS101	CuNi10Zn42Pb2	CW402J
-	CuAl10Fe1	CW305G	-	CuNi12Zn38Mn5Pb2	CW407J
-	CuAl10Fe3Mn2	CW306G			
CA104	CuAl10Ni5Fe4	CW307G			
-	CuAl11Fe6Ni6	CW308G			

Listing of Old BS Standards replaced by EN Standards		
Old BS Standard	Title (abbreviated)	EN Standards
1400	Copper and copper alloy ingots and castings	1982
1432	Drawn copper strip for electrical purposes	13601
1433	Copper rod and bar for electrical purposes	13601
1434	Copper sections in bars, blanks and segments for commutators (electrical purposes)	n/a
1453	Filler metals for gas welding	13347
1845	Filler metals for brazing	13347
1977	Copper tubes for electrical purposes	13600
2870	Sheet, strip and foil	1172,1652,1653,1654
2871 Pt 1	Tubes for water, gas and sanitation	1057
2871 Pt 2	Tubes for general purposes	12449
2871 Pt 3	Tubes for heat exchangers	12451
2872	Forgings and forging stock	12165, 12420
2873	Wire	12166
2874	Rods and sections	12163, 12164, 12167
2875 Pt 3	Plate	1652, 1653

Wrought Low-Alloyed Copper Alloys- Compositions, Uses, Typical Mechanical Properties, Relevant Standards and Approximate Electrical Conductivity																
Material Designation		Composition, %, Range or Max							Others & Total Impurities	Nearest Old BS Equivalent	Characteristics and Uses	Typical Mechanical Properties				Approx. Conductivity % IACS
Symbol	Number	Cu	Be	Cr	Ni	P	Si	0.2% Proof Strength (N/mm ²)				Tensile Strength (N/mm ²)	Elongation (%)	Hardness (HV)		
Heat Treatable Alloys																
CuBe1.7	CW100C	Rem.	1.6-1.8					0.5	CB101	High Strength beryllium coppers for springs and pressure sensitive devices. CW102C is the free machining version.	200-1100	410-1300	35-3	100-400	30	
CuBe2	CW101C	Rem.	1.8-2.1					0.5	-		200-1300	410-1400	20-2	100-420	30	
CuBe2Pb	CW102C	Rem.	1.8-2.0					0.2-0.6 Pb 0.5	-		200-1300	410-1400	20-4	100-210	45	
CuCoNi1Be	CW103C	Rem.	0.4-0.7		0.8-1.3			0.8-1.3 Co 0.5	-	Beryllium containing alloys with lower strength and better conductivity and ductility than beryllium copper, also suitable for higher temperature service.	135-760	250-800	25-3	100-230		
CuCo2Be	CW104C	Rem.	0.4-0.7					2.0-2.8 Co 0.5	C112		135-900	240-800	25-3	90-230	45	
CuNi2Be	CW110C	Rem.	0.2-0.6		1.4-2.4			0.5	-		135-900	240-800	25-3	90-230		
CuCr1	CW105C	Rem.		0.5-1.2				0.2	CC101	Resistance Welding electrode materials. Good conductivity and strength at elevated temperatures. Zr in CW106C raises softening temperature.	100-440	220-500	30-8	70-185	80	
CuCr1Zr	CW106C	Rem.		0.5-1.2				0.03-0.3 Zr 0.2	CC102		100-440	220-540	35-5	55-175	75	
CuNiP	CW108C	Rem.			0.8-1.2	0.15-0.25		0.1	C113	As silicon is added and increased, strength and wear resistance increase and conductivity decreases. Electrode holders, seam welding wheel shafts, welding dies and bearing cages.	140-730	250-800	30-5	80-240	50	
CuNi1Si	CW109C	Rem.			1.0-1.6		0.4-0.7	0.3			100-570	300-590	30-5	80-220		
CuNi2Si	CW111C	Rem.			1.6-2.5		0.4-0.8	0.3			100-620	300-700	35-5	80-220	40	
CuNi3Si1	CW112C	Rem.			2.6-4.5		0.8-1.3	0.5			120-780	320-800	30-5	80-230		
CuZr	CW120C	Rem.						0.1-0.2 Zr 0.1		Special applications at elevated temperatures.	40-350	180-350	30-14	40-135	85-90	
Non Heat-treatable Alloys – Free Machining																
CuPb1P	CW113C	Rem.				0.003-0.012		0.7-1.5 Pb 0.1		Free machining high conductivity coppers with machinability index of about 80%	200-320	250-360	7-2	90-110	75	
CuSP	CW114C	Rem.				0.003-0.012		0.2-0.7 S 0.1	C111		200-320	250-360	7-2	90-110	93	
CuTeP	CW118C	Rem.				0.003-0.012		0.4-0.7 Te 0.1	C109		200-320	250-360	7-2	90-110	90	



Wrought Copper-aluminium, Copper-nickel and Copper-nickel-zinc Alloys – Compositions, Uses, Typical Properties, Relevant Standards and Machinability																
Material Designation		Composition, %, Range or Max								Nearest Old BS Equivalent	Characteristics and Uses	Typical Mechanical Properties				Approx. Conductivity % IACS
Symbol	Number	Cu	Al	Fe	Mn	Ni	Pb	Si	Others & Total Impurities			0.2% Proof Strength (N/mm ²)	Tensile Strength (N/mm ²)	Elongation (%)	Hardness (HV)	
Copper-aluminium (Aluminium Bronze)																
CuAl5As	CW300G	Rem.	4.0-6.5						0.1-0.4 AS 0.3		An alpha phase alloy for tube manufacture. May be heavily cold worked.	130	380	55	85	20
CuAl6Si2FE	CW301G	Rem.	6.0-6.4	0.5-0.7				2.0-2.4	0.2	CA107	Medium strength alloys, readily hot worked and moderately cold workable. With machinability of 40-50%, the alloys are suitable for manufacture of items of chemical plant, machine parts, tools and instruments when good corrosion resistance is required.	250-350	500-650	25-10	125-160	50
CuAl7Si2	CW302G	Rem.	7.3-7.6					1.5-2.2	0.2			250-350	500-650	25-10	125-160	50
CuAl8Fe3	CW303G	Rem.	6.5-8.5	1.5-3.5					0.2	CA106		180-210	460-500	30	125-135	20
CuAl9Ni3Fe2	CW304G	Rem.	8.0-9.5	1.0-3.0		2.0-4.0			0.2	CA105		180	500	30	125	20
CuAl10Fe1	CW305G	Rem.	9.0-10.0	0.5-1.5					0.3	-		210-480	420-670	22-5	110-205	20
CuAl10Fe3Mn2	CW306G	Rem.	9.0-11.0	2.0-4.0	1.5-3.5				0.2	-		330-510	600-720	15-5	130-210	30
CuAl10Ni5Fe4	CW307G	Rem.	8.5-11.0	3.0-5.0		4.0-6.0			0.2	CA104	High strength alloys for use in aggressive media when wear resistance and good impact strength are required.	400-530	600-760	15-5	170-220	30
CuAl11FE6Ni6	CW308G	Rem.	10.5-12.5	5.0-7.0		5.0-7.0			0.2	-		500-680	750-850	10-5	200-260	30
Copper-nickel																
CuNi25	CW350H	Rem.				24.0-26.0			0.1	CN105	UK "silver" coinage alloy.	120	300	-	85	20
CuNi9Sn2	CW351H	Rem.				8.5-10.5			1.8-2.8 Sn 0.1	-	Good elastic properties for electrical contacts.	200-550	350-620	45-2	80-220	20
CuNi10Fe1Mn	CW325H	Rem.		1.0-2.0	0.5-1.0	9.0-11.0			0.2	CN102	Excellent sea-water corrosion resistance. The alloys with 30% nickel have good resistance to erosion.	100-420	290-520	35-8	80-160	20
CuNi30Fe2Mn2	CW353H	Rem.		1.5-2.5	1.5-2.5	29.0-32.0			0.2	CN108		175	450	35	110	20
CuNi30Mn1FE	CW354H	Rem.		0.4-1.0	0.5-1.5	30.0-32.0			0.2	CN107		130-330	350-520	35-12	90-130	20
Copper-nickel-zinc (Nickel-Silver)																
CuNi10Zn27	CW401J	Rem.	61.0-64.0			9.0-11.0			Zn. Rem. 0.2	NS103	Alpha phase alloys with good corrosion resistance. Colour becomes whiter as nickel content increases. Lead, when present, improves machinability. Applications include tableware, telecommunication components, decorative building features and general mechanical and food manufacturing equipment.	180-880	360-880	50-2	80-210	30



Wrought Copper-zinc-lead Alloys (Leaded Brasses) – Compositions, Uses, Typical Properties, Relevant Standards and Machinability															
Material Designation		Composition, %, Range or Max							Nearest Old BS Equivalent	Characteristics and Uses	Typical Mechanical Properties				Machinability Index (%)
Symbol	Number	Cu	Al	As	Pb	Sn	Zn	Others & Total Impurities			0.2% Proof Strength (N/mm ²)	Tensile Strength (N/mm ²)	Elongation (%)	Hardness (HV)	
CuZn36Pb3	CW603N	60-62.0			2.5-3.5		Rem.	0.2	CZ124	These alloys have excellent machinability but very limited cold workability. Alloy CW614N is rated as a standard against which other materials are compared. Alloy CW617N is the standard hot forging brass.	160-450	340-580	35-5	90-150	95
CuZn39Pb3	CW614N	57.0-59.0			2.5-3.5		Rem.	0.2	CZ121Pb3		150-420	360-580	25-5	100-160	100
CuZn40Pb2	CW617N	57.0-59.0			1.6-2.5		Rem.	0.2	CZ122		150-420	360-580	25-5	100-160	90
CuZn37Pb2	CW606N	61.0-62.0			1.6-2.5		Rem.	0.2	CZ119, CZ131	These alloys have good machinability and some cold workability for limited bending and riveting.	160-450	300-580	45-5	90-150	70
CuZn38Pb2	CW608N	60.0-61.0			1.6-2.5		Rem.	0.2	CZ120, CZ128		150-450	360-580	40-5	90-150	75
CuZn39Pb2	CW612N	59.0-60.0			1.6-2.5		Rem.	0.2	CZ120, CZ128		150-450	360-580	40-5	90-160	80
CuZn35Pb1	CW600N	62.5-64.0			0.8-1.6		Rem.	0.1	CZ118	These alloys are machinable and have a good to very good cold workability. This group contains the standard alloys for bending, CW610N, and extreme riveting, CW601N.	150-450	300-580	45-10	90-150	50
CuZn35Pb2	CW601N	62.0-63.5			1.6-2.5		Rem.	0.1	CZ119, CZ131		150-350	330-470	30-10	90-130	65
CuZn38Pb1	CW607N	60.0-61.0			0.8-1.6		Rem.	0.2	-		150-420	360-580	30-5	90-150	55
CuZn39Pb0.5	CW610N	59.0-60.5			0.2-0.8		Rem.	0.2	CZ123, CZ137		150-450	360-580	40-5	90-150	50
CuZn39Pb1	CW611N	59.0-60.0			0.8-1.6		Rem.	0.2	CZ129		150-420	360-580	30-5	90-150	60
CuZn36Pb2As	CW602N	61.0-63.0		0.02-0.15	1.7-2.8		Rem.	0.2	CZ132	Dezincification resistant brass with good machinability and moderate hot and cold workability.	120-200	280-450	40-20	80-140	70
CuZn39Pb2Sn	CW613N	59.0-60.0			1.6-2.5	0.2-0.5	Rem.	0.2	-	These alloys have good machinability and limited cold workability.	150-420	360-580	30-5	90-150	75
CuZn40Pb2Sn	CW619N	57.0-59.0			1.6-2.5	0.2-0.5	Rem.	0.2	-		150-420	360-580	25-5	100-160	85
CuZn39Pb3Sn	CW615N	57.0-59.0			2.5-3.5	0.2-0.5	Rem.	0.2	-	These alloys are designed for hot forging.	130-160	340-380	20-12	85-95	95
CuZn40Pb1Al	CW616N	57.0-59.0	0.05-0.30		1.0-2.0		Rem.	0.2	-		130-160	340-380	20-12	85-95	60
CuZn40Pb2Al	CW618N	57.0-59.0	0.05-0.5		1.6-3.0		Rem.	0.2	-	This group of alloys is used for production of profiles by hot extrusion. Aluminium imparts a golden lustre, avoiding need for further polishing. The alloys with more than 1.6% Pb have very good machinability.	-	-	-	-	90
CuZn41Pb1Al	CW620N	57.0-59.0	0.05-0.5		0.8-1.6		Rem.	0.2	-		-	-	-	-	85
CuZn42PbAl	CW612N	57.0-59.0	0.05-0.5		0.2-0.8		Rem.	0.2	-		-	-	-	-	55
CuZn43Pb1Al	CW622N	55.0-57.0	0.05-0.5		0.8-1.6		Rem.	0.2	-		-	-	-	-	60
CuZn43Pb2Al	CW624N	55.0-57.0	0.05-0.5		1.6-3.0		Rem.	0.2	CZ130		-	-	-	-	95
CuZn43Pb2	CW623N	55.0-57.0			1.6-3.0		Rem.	0.2	CZ130	150-220	350-420	30-20	100-130	95	
CuZn37Pb0.5	CW604N	62.0-64.0			0.1-0.8		Rem.	0.2	-	For manufacture of plate and tube.	160-450	300-580	45-10	80-150	45
CuZn37Pb1	CW605N	61.0-62.0			0.8-1.6		Rem.	0.2	-	For manufacture of tube and hollow rod.	160-340	340-440	35-10	80-130	50

Wrought Copper-zinc and Copper-tin Binary Alloys – Compositions, Uses and Typical Properties														
Material Designation		Composition, %, Range or Max							Nearest Old BS Equivalent	Characteristics and Uses	Typical Mechanical Properties			
Symbol	Number	Cu	P	Pb	Sn	Zn	Others	0.2% Proof Strength (N/mm ²)			Tensile Strength (N/mm ²)	Elongation (%)	Hardness (HV)	
Copper-zinc (Brass)														
CuZn5	CW500L	94.0-96.0				Rem.	0.1	CZ125	Very good cold working properties for electrical engineering components. Flexible tubes and sleeves. Attractive range of colours for costume jewellery. Can easily be enamelled.	60-240-420	240-420	45-4	50-25	
CuZn10	CW501L	89.0-91.0				Rem.	0.1	CZ101		120-560	240-600	45-2	60-165	
CuZn15	CW502L	84.0-86.0				Rem.	0.1	CZ102		120-590	260-630	50-2	65-170	
CuZn20	CW503L	79.0-81.0				Rem.	0.1	CZ103		120-590	260-630	50-2	65-170	
CuZn28	CW504L	71.0-73.0				Rem.	0.1	-	Very good cold working properties for extreme deep drawing and cold forging applications.	120-420	310-500	30-2	90-160	
CuZn30	CW505L	69.0-71.0				Rem.	0.1	CZ106		130-810	300-830	55-1	65-200	
CuZn33	CW506L	66.0-68.0				Rem.	0.1	-		120-420	300-500	30-2	65-160	
CuZn36	CW507L	63.5-65.5				Rem.	0.1	CZ107	The standard alloys for deep drawing, spinning, upsetting, thread rolling and bending. Good soldering properties.	130-800	280-820	50-1	65-190	
CuZn37	CW508L	62.0-64.0				Rem.	0.1	CZ108		130-800	280-820	50-1	65-190	
CuZn40	CW509L	59.5-61.5				Rem.	0.2	CZ109		200-420	340-500	45-2	90-150	
Copper-tin (Phosphor Bronze)														
CuSn4	CW450K	Rem.	0.01-0.4		3.5-4.5		0.2	PB101	Strength increases as tin content increases. Good corrosion and corrosion fatigue properties lead to uses such as springs, instrument components, wire cloth, condenser tube-plates and vessels, and electronic components. Controlled resistivity wire for power applications.	140-850	320-950	60-1	75-230	
CuSn5	CW451K	Rem.	0.01-0.4		4.5-5.5		0.2	PB102		140-850	320-950	60-1	75-230	
CuSn6	CW452K	Rem.	0.01-0.4		5.5-7.0		0.2	PB103		140-950	340-1000	60-1	80-250	
CuSn8	CW453K	Rem.	0.01-0.4		7.5-8.5		0.2	PB104		170-1000	390-1100	60-1	85-270	

Wrought Complex, Copper-zinc Alloys (Special Brasses) – Compositions, Uses and Typical Properties																	
Material Designation		Composition, %, Range or Max										Nearest Old BS Equivalent	Characteristics and Uses	Typical Mechanical Properties			
Symbol	Number	Cu	Al	Fe	Mn	Pb	Si	Sn	Others	Zn	0.2% Proof Strength (N/mm ²)			Tensile Strength (N/mm ²)	Elongation (%)	Hardness (HV)	
Corrosion Resistant Alloys																	
CuZn36Sn1Pb	CW712R	61.0-63.0				0.2-0.6		1.0-1.5		Rem.	CZ112	Naval Brasses for sea-water environments; 60-70% machinability when lead is included.	160-360	340-480	30-10	90-150	
High Tensile Brasses																	
CuZn23Al6Mn4Fe3Pb	CW704R	63.0-65.0	5.0-6.0	2.0-3.5	3.5-5.0	0.2-0.8				Rem.	-	High Strength structural materials. CW722R is aluminium-free and suitable for brazing and soldering. Machinability 50-80%.	500-540	700-800	10	190-210	
CuZn25Al5Fe2Mn2Pb	CW705R	65.0-68.0	4.0-5.0	0.5-3.0	0.5-3.0	0.2-0.8				Rem.	CZ116		300-400	550-650	12	150-200	
CuZn35Ni3Mn2AlPb	CW710R	58.0-60.0	0.3-1.3		1.5-2.5	0.2-0.8			2.0-3.0Ni	Rem.	-		250-350	450	15	120-150	
CuZn40Mn1Pb1AlFeSn	CW721R	57.0-59.0	0.3-1.3	0.2-1.2	0.8-1.8	0.8-1.6		0.2-1.0		Rem.	CZ114		200-380	450-580	30-15	130-170	
CuZn40Mn1Pb1FeSn	CW722R	56.5-58.5		0.2-1.2	0.8-1.8	0.8-1.6		0.2-1.0		Rem.	CZ115		200-380	450-580	30-15	130-170	
CuZn31Si1	CW708R	66.0-70.0					0.7-1.3			Rem.	-		200-380	450-580	30-15	130-170	
CuZn37Mn3Al2PbSi	CW713R	57.0-59.0	1.3-2.3		1.5-3.0	0.2-0.8	0.3-1.3			Rem.	CZ135		Bearings and sliding stress requirements, synchro rings. Machinability 40-50%.	300-450	550-650	25-8	170-210
CuZn39Mn1AlPbSi	CW718R	57.0-59.0	0.3-1.3		0.8-1.8	0.2-0.8	0.2-0.8			Rem.	-	NO-350	440-540	20-10	120-170		

Copper and Copper alloys are amongst the most versatile materials available and are used for applications in every type of industry. World consumption of Copper now exceeds 18 million tonnes per annum.

Copper is well known for its conductivity but it has other properties that have been exploited in a wide range of copper alloys. These alloys have been developed for a wide variety of applications and numerous fabrication processes employed to produce finished goods.

Fabrication techniques that copper alloys are largely suited to include machining, forming, stamping, joining, polishing and plating.

The exceptional machinability of some Copper alloys means that free machining brass sets the standard of machinability by which all other metals are judged.

Handling and Storage

The procedures for the handling and storage of Copper and Copper alloys are very similar to those used for Aluminium and stainless steel.

The most important factor is cleanliness. Contaminated Copper can be the cause of cracking or porosity during heat treatment or welding. Corrosion resistance can also be adversely affected. Tooling and work surfaces should be dedicated to use with Copper materials or thoroughly cleaned before use. If this rule is not adhered to, cross contamination can occur.

Copper sheets should remain in their packaging until required and should be kept separated by protective material to avoid abrasion between the sheets.

Plates and sheets should be stored vertically in covered racks. All Copper materials should never be walked upon.

Ductility and Malleability

The ductility and malleability of Copper and Copper alloys makes them ideally suited to fabrication methods that involve severe deformation such as:

- Tube forming
- Wire drawing
- Spinning
- Roll forming
- Deep drawing

These fabrication methods require specialised, heavy equipment and skilled operators. If fabrication by one of these methods is required, more information should be sought independently.

Cutting

Most Copper alloys are relatively soft and can be readily cut using common hand tools and standard cutting methods.

While the relative softness of Copper makes it easy to cut, it is important to protect the component from unwanted damage during cutting. This damage may include, but not be limited to, bending, denting or scratching.

Pipe and Tube Cutting

When cutting Copper pipe, a fine toothed hacksaw may be used quite successfully. To ensure the cut is square to the pipe, a tube cutter should be used.

When a pipe cutter is used, it is recommended to grip the Copper tubing with a pipe vice or a similar holding device.

To hold material for cutting with a hacksaw use a mitre box or a jig consisting of a piece of wood containing a notch to hold the tube or pipe in place.

After cutting any burrs need to be removed from the inside and outside of the tube. For this, use a half round file. Pipe cutters tend to cause more burrs than do hacksaws.

Cutting Copper Sheet and Plate

The method employed for cutting Copper sheet or plate largely depends on two factors; the thickness of the material and the amount of cutting required.

For thin gauge material where only a minimal amount of cutting is to be done, tin snips or hand shears may be adequate. Thicker material can be cut using a bandsaw or other mechanical saw fitted with a bimetallic blade suited to the cutting of Copper alloys. For large cutting runs or for thick material it may be necessary to utilise one of the common industrial cutting methods like:

- Shearing
- Electrical discharge machining (EDM)
- Laser cutting
- Water jet cutting
- Plasma cutting
- Slitting
- Guillotining
- Abrasive disc cutting

Tube and Pipe Bending

Most Copper pipe/ tube can be readily bent and two main methods are employed. The first uses bending springs and the second, a pipe bending machine.

The simplest tool for bending pipe is the bending spring. Bending springs are normally used for thinner walls where the pipe can be bent by hand. Two types of spring are used: internal and external. Both types of spring serve the same function; to prevent the wall of the pipe from collapsing during bending.

External springs are used for smaller diameter copper piping (6 to 10mm external diameter). As the name suggests, the spring is fitted over the tube during the bending operation. Internal springs are placed inside the pipe during bending.

Each pipe size requires its own specific size of spring.

All bending machines are different but the principal is the same.

The bending machine is fitted with a bending roller and former matched to the size of the pipe. The pipe is secured at one end and the lever handle of the machine moved to bend the pipe around the former.

Bar and Flat Bending

Copper and Copper alloy bar can be bent using standard bending methods.

As a general rule, the minimum bending radius for copper bar is equal to the thickness of the bar.

Joining of Copper Components

Copper and Copper alloys are more readily joined than most other materials used in engineering.

Although 90% of Copper based components are assembled using conventional welding and brazing techniques, they can be successfully joined using every known joining process.

When welding, soldering or brazing Copper the joint must be clean and free of dirt, grease or paint.

Soldering

Soldering can be divided into two methods:

- Soft soldering using alloys that melt below 350°C
- Hard soldering using stronger, high melting point alloys

In regard to soldering Copper alloys, hard soldering is often referred to as Silver soldering.

Soft soldering normally uses Tin based solders for joining Copper and brass when high mechanical strength is not required. The method is commonly used for joining Copper in domestic electrical and plumbing applications.

Brazing

With the exception of alloys containing more than around 10 per cent Aluminium or 3 per cent Lead, brazing can be used to join all Copper alloys.

Brazing is particularly popular for joining Copper components used in building, heating, ventilation, air-conditioning and the manufacturing of electronic products.



Welding

Copper alloys are readily welded using all common welding techniques including:

- Arc welding
- Gas-shielded arc welding
- Tungsten inert gas (TIG) welding
- Metal inert gas (MIG) welding
- Plasma arc welding
- Pulsed-current MIG welding
- Electron Beam welding
- Laser welding
- Friction welding
- Ultrasonic welding

Bolting and Riveting

Copper and all Copper alloys can be successfully bolted or riveted. However consideration must be given to the material used in the bolts or rivets. As Copper is often chosen for its corrosion resistance, the material used in the bolts and rivets should be made from the same or similar material to that being joined. For roofing applications, Copper nails are preferred but brass or stainless steel can be substituted.

Mechanical joining like bolting and riveting may induce localised areas of high stress, which could induce failure in the component. Replacing the mechanical joint with adhesive bonding can eliminate this. Adhesive bonding can also be used in conjunction with mechanical bonding.

Adhesive Bonding

With consideration given to joint design so there is an adequate overlap on the joint area, Copper and Copper alloys can be successfully joined using adhesive bonding.

As Copper and Copper alloys form a protective surface oxide layer, the surfaces must be cleaned before the adhesive is applied.

Casting

Copper and many Copper alloys are ideally suited to fabrication of components by casting.

The most flexible casting technique utilises sand moulds. Sand moulds can be used for production runs from simple one-off items to long casting runs. These items can also range in size from a few grams to many tonnes.

The other popular casting technique uses iron moulds and is called die casting. Die casting is suited to long casting runs.

Both die casting and sand casting can be used for the low cost production complex near net-shape components. This minimises expensive post casting machining.

Bars, sections and hollows that require tight dimensional control are often produced by continuous casting.

Rings, discs and other symmetrical shapes tend to be produced using centrifugal casting.

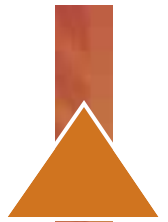

Machining

All Coppers and Copper alloys can be machined accurately, cheaply, with a good tolerance standard and good surface finish. Some Copper alloys are specifically formulated to have excellent machinability.

If machinability is the paramount consideration for the material, the material of choice is high speed machining brass.

The relative machinability of metals is demonstrated by a percentage rating. This rating system is based on the original free machining brass (CZ121 / CW614N) which has a rating of 100.

Descaling

The surface oxide films that form on Copper alloys can prove to be quite tenacious. Often these films need to be removed before some fabrication processes can be performed.

Very fine abrasive belts or discs can be used to remove oxides and discolouration adjacent to welds.

Pickling might be necessary by using a hot 5-10% sulphuric acid solution containing 0.35g/l potassium dichromate. Before commencing pickling, oxides can be broken up by a grit blast. Components that have been pickled should be rinsed thoroughly in hot, fresh water and finally dried in hot air.

Finishing

Copper components can be finished in a vast variety of ways. The finish used for any given Copper component is dependent upon function and/or aesthetics. Copper naturally forms a protective oxide layer on exposure to the elements. This layer is normally blue – green and may or may not be desirable.

The blue – green patina develops over time but its development can be enhanced and accelerated by the use of commercially available oxidising agents.

If the tarnished patina of Copper is not desirable, the material can be protected using a lacquer coating. An acrylic coating with benzotriazole as an additive will last several years under most outdoor, abrasion-free conditions.

Painting

In most instances Copper and Copper alloys do not require painting. The inherent properties of Copper resist corrosion and biofouling. Painting of Copper is occasionally done for aesthetic reasons. It is also done to reduce the incidence of metal to metal contact of bimetallic couples where galvanic corrosion might be a problem.

Before painting Copper, the surface of the material should be roughened by grit or sand blasting. Other specific procedures will depend upon the type of paint being used. Please consult the paint manufacturer for details.



Cleaning and Polishing Copper

The best way to keep Copper clean is to not allow it to get dirty in the first place.

Where possible, decorative items should be kept clean and free of dust. Many decorative copper items are coated with lacquer to protect the finish. Other than dusting, for these items occasional washing with luke warm, soapy water may be required. They should never be polished as this may remove the protective lacquer.

To remove tarnish from Copper cookware, simply rub with lemon halves dipped in salt.

Tarnish can be removed from Copper in industrial applications using commercial copper polishes. These polishes should be applied following the manufacturers instructions.

If a brushed finish is required on Copper or copper alloys, stainless steel brushes must be used to eliminate cross contamination.

Recycling

Copper alloys are highly suited to recycling. Around 40% of the annual consumption of Copper alloys comes from recycled copper materials. Both process scrap and the component, at the end of its working life, can be readily recycled.

Corrosion Susceptibility of Metals

Most susceptible to corrosive attack (less noble)

Magnesium and its alloys
 Zinc and its alloys
 Aluminium and its alloys
 Cadmium
 Mild steel
 Cast iron
 Stainless steel, 13% Cr, type 410 (active)
 Lead-tin solder, 50/50
 Stainless steel, 18/18 type 304 (active)
 Stainless steel, 18/18/3% Mo, type 316 (active)
 Lead
 Tin
BRASSES
 Gunmetals
 Aluminium Bronzes
 Copper
 Copper-nickel alloys
 Monel
 Titanium and its alloys
 Stainless steel, 18/8, type 304 (passive)
 Stainless steel, 18/8/3 Mo, type 316 (passive)
 Silver
 Gold
 Platinum

Least susceptible to corrosive attack (more noble)

Imperial Wire and Sheet Metal Gauge

No.	Imperial Standard (swg)	
	ins	mm
0	0.324	8.23
1	0.300	7.62
2	0.276	7.01
3	0.252	6.40
4	0.232	5.89
5	0.212	5.38
6	0.192	4.48
7	0.176	4.47
8	0.160	4.06
9	0.144	3.66

No.	Imperial Standard (swg)	
	ins	mm
10	0.128	3.25
11	0.116	2.95
12	0.104	2.64
13	0.092	2.34
14	0.080	2.03
15	0.072	1.83
16	0.064	1.63
17	0.056	1.42
18	0.048	1.22
19	0.040	1.02

No.	Imperial Standard (swg)	
	ins	mm
20	0.036	0.914
21	0.032	0.813
22	0.028	0.711
23	0.024	0.610
24	0.0220	0.559
25	0.0200	0.508
26	0.0180	0.457
27	0.0164	0.417
28	0.0148	0.376



Conversion Factors

Description	From Unit	To Units	Multiply by
Angstrom units to microns			0.001
Atmospheres (standard) to pounds per square inch	A	lbf/in ² (psi)	14.70
Atmospheres (standard) to Pascal	A	Pa	101325
Bar to kilograms force per square centimetre	bar	kgf/cm ²	1.0197
Bar to pounds force per square inch	bar	lbf/in ² (psi)	14.5038
Centigrade to Fahrenheit	°C	°F	multiply by 1.8 and add 32
Centimetres to feet	cm	ft	0.03280840
Centimetres to inches	cm	in	0.393701
Centimetres ³ to feet ³	cm ³	ft ³	0.0000353147
Centimetres ³ to inches ³	cm ³	in ³	0.06102376
Fahrenheit to Centigrade	°F	°C	subtract 32 and multiply 0.5555
Feet per second to miles per hour	ft/s	mph	0.681818
Feet to centimetres	ft	cm	30.48
Feet to metres	ft	m	0.3048
Feet to millimetres	ft	mm	304.8
Feet ³ to metres ³	ft ³	m ³	0.02831685
Feet ³ to gallons	ft ³	gal	6.2288
Foot pounds to kilogram metres	ftlb	kgm	0.1382
Gallons (UK) to litres	gal	l	4.546092
Gallons (US) to litres	gal	l	3.785412
Grams per centimetres ³ to pounds per inch ³ (density)	gm/cm ³	lb/in ³	0.0361275
Grams to ounces	gm	oz	0.035274
Grams to pounds	gm	lb	0.00220462
Inches to centimetres	in	cm	2.540
Inches to metres	in	m	0.0254
Inches to millimetres	in	mm	25.4
Inches ³ to centimetres ³	in ³	cm ³	16.38706
Inches ³ to litres	in ³	l	0.01639
Kilogram metres to foot pounds	kgm	ftlb	7.233
Kilograms force to bar	kgf	B	0.9807
Kilograms force to Newtons	kgf	N	9.806650
Kilograms per metre to pounds per foot (assuming constant cross sectional area)	kg/m	lb/ft	0.671970
Kilograms per square centimetre to pounds per square inch	kg/cm ²	lb/in ² (psi)	14.223
Kilograms per square metre to pounds per square foot	kg/cm ²	lb/ft ²	0.2048
Kilograms per square metre to Newtons per square metre	kg/m ²	N/m ²	9.806650
Kilograms per square millimetre to pounds per square inch	kg/mm ²	lb/in ² (psi)	1422.34
Kilograms per square millimetre to tons per square inch	kg/mm ²	ton/in ²	0.63497
Kilograms to pounds	kg	lb	2.205
Kilograms to tons (long)	kg	ton	0.0009842
Kilometres to miles	km	mile	0.62137
Litres of water at 62°F to pounds	l	lb	2.205
Litres to inches ³	l	in ³	61.03
Litres to gallons (UK)	l	gal	0.2199692
Litres to gallons (US)	l	gal	0.2641720
Metres to inches	m	in	39.37008
Metres to microns			1 million
Metres to miles	m	miles	0.000621371
Metres to feet	m	ft	3.28084
Metres to yards	m	yd	1.093613
Metre ³ to inch ³	m ³	in ³	61023.76
Metre ³ to feet ³	m ³	ft ³	35.31466

Description	From Unit	To Units	Multiply by
Metre ³ to gallon (UK)	m ³	gallon	219.9692
Metre ³ to gallon (US)	m ³	gallon	264.1720
Metre ³ to litre	m ³	l	1000.0
Metre ³ to yard ³	m ³	yd ³	1.307951
Metric tons (or tonnes, 1000kg) to long tons	tonne	ton	0.9842
Microns to Angstrom units			1000
Microns to metres			0.000001
Microns to millimetres			0.001
Microns to thousands of an inch			0.03937008
Miles per hour to feet per second	mph	ft/s	1.46666
Miles to kilometres	m	km	1.60934
Millimetres to feet	mm	ft	0.003280840
Millimetres to inches	mm	in	0.03937008
Millimetres to microns			1000
Millimetres to thousands of an inch			39.37008
Newtons per square metre (Pascal) to kilograms per square metre	N/m ² (Pa)	kg/m ²	0.1019716
Newtons per square millimetre to pounds per square inch	N/mm ²	lb/in ² (psi)	145.0377
Newtons per square millimetre to tons per square inch	N/mm ²	tons/in ²	0.06475
Newtons to kilograms force	N	kgf	0.1019716
Newtons to pound force	N	lbf	0.2248089
Ounces to grams	oz	gm	28.3495
Pints imperial litres	pt	l	0.5679
Pounds force to Newtons	lbf	N	4.448222
Pounds per inch ³ to grams per centimetre ³ density	lb.in ³	gm/cm ³	27.67990
Pounds per foot to kilograms per metre (assuming constant cross sectional area)	lb/ft	kg/m	1.4882
Pounds per squarefoot to kilograms per square metre	lb/ft ²	kg/m ²	4.882429
Pounds per square inch to atmospheres	lb/in ² (psi)	A	0.06803
Pounds per square inch to bars	lb/in ² (psi)	bar	0.06894757
Pounds per square inch to kilograms per square centimetre	lb/in ² (psi)	kg/cm ²	0.07030697
Pounds per square inch to kilograms per square millimetre	lb/in ² (psi)	kg/cm ²	0.0007030697
Pounds per square inch to Newtons per square millimetre	lb/in ² (psi)	N/mm ²	0.006894757
Pounds to grams	lb	gm	453.60
Pounds to kilograms	lb	kg	0.453593
Square centimetres to square inches	cm ²	in ²	0.1550003
Square feet to square metres	ft ²	m ²	0.09290304
Square inches to square centimetres	in ²	cm ²	6.4516
Square inches to square millimetres	in ²	mm ²	645.16
Square kilometres to square miles	km ²	miles ²	0.386103
Square metres to square feet	m ²	ft ²	10.763910
Square metres to square yards	m ²	yd ²	1.195990
Square miles to square kilometres	miles ²	km ²	2.590
Square millimetres to square inches	mm ²	in ²	0.001550003
Square yards to square metres	yd ²	m ²	0.8361274
Tons per square inch to kilograms per square millimetre	ton/in ²	kg/mm ²	1.575
Tons per square inch to Newtons per square millimetre	ton/in ²	N/mm ²	15.4443
Tons (long) to kilograms	ton	kg	1016.047
Tons (long) to metric tons (or tonne, 1000kg)	ton	tonne	1.016047
Yards to metres	yd	m	0.9144
Yards ³ to metres ³	yd ³	m ³	0.7645549

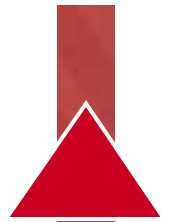

Formulae for Calculation

All weights shown in this publication are theoretical weights for guidance only. They are calculated using nominal dimensions and scientifically recognised densities. The formulae used are shown below together with the densities of the alloys. Please note that in practice, the actual weight can vary significantly from the theoretical weight due to variations in manufacturing tolerances and compositions.

Form	Dimensions in mm	Weight for Alloys of Density p Kg/dm ³	
Round	Diameter = d	$0.00078540 d^2 p$	Kg/m
Hexagon	Width across flats = f	$0.00086603 f^2 p$	Kg/m
Square	Side = a	$0.00100 a^2 p$	Kg/m
Flat	Width = w Thickness = t	$0.00100 wtp$	Kg/m
Angle/Tee	Leg lengths = L_1, L_2 Thickness = t	$0.00100 (L_1 + L_2)t p$	Kg/m
Channel	Leg lengths = L_1, L_2 Base = B Thickness = t	$0.00100 (B + L_1 + L_2 - 2t)t p$	Kg/m
Plate/Sheet	Thickness = t Length = L Width = w	tp $0.000001 Lwtp$	Kg/m Kg/Sheet
Strip	Width = w Thickness = t	$0.100 wtp$	Kg/100m
Pipe/Tube (Round)	Outside diameter = D Inside diameter = d Wall thickness = t	$0.0031416 (D-t)t p$, or $0.0031416 (d+t)t p$	Kg/m
Square/Rectangular Tube	Sides = a_1, a_2 Wall thickness = t	$0.001 (2a_1 + 2a_2 - 4t)t p$	Kg/m
Wire	Diameter = d	$0.78540 d^2 p$	Kg/Km

Comparative Properties

Metal	Density	Melting Temp °C	Thermal Conductivity	Electrical Resistivity	UTS	Proof Stress	Elongation %	Typical Young's Modulus GPa
Aluminium pure	2.7	660	201	2.65	105	85	4	68
Aluminium alloy	2.7	660	184	3.7	310	260	7	68 to 89
Brass CZ121	8.5	954	110	6.33	400	190	20	103 to 120
Copper C101	8.9	1083	385	1.67	360	280	15	128 to 131
Iron	7.8	1537	80	9.71	210	120	40	152 to 183
Lead	11.3	327	35	20.65	20	0	60	16 to 18
Nickel alloy (Nimonic 105)	7.9	1327	12	132.0	990	800	5	180 to 234
Stainless Steel (18CR/8Ni)	7.9	1527	150	70	570	215	30	205 to 215
Mild Steel	7.8	1427	63	12	690	350	20	196 to 211
Tin	7.3	232	65	12.8	25	20	60	44 to 53

Chemical Elements

Aluminium – **Al**
 Arsenic – **As**
 Boron – **B**
 Cadmium – **Cd**
 Carbon – **C**
 Chromium – **Cr**
 Cobalt – **Co**
 Columbium – **Cb***
 Copper – **Cu**
 Hydrogen – **H**

Iron – **Fe**
 Lead – **Pb**
 Lithium – **Li**
 Manganese – **Mn**
 Molybdenum – **Mo**
 Nickel – **Ni**
 Niobium – **Nb**
 Nitrogen – **N**
 Oxygen – **O**
 Phosphorus – **P**

Selenium – **Se**
 Silicon – **Si**
 Sulphur – **S**
 Tellurium – **Te**
 Tin – **Sn**
 Titanium – **Ti**
 Zinc – **Zn**
 Zirconium – **Zr**

* The American designation for Niobium

Densities

Material	Density Kg/dm ³
Aluminium	2.70
Stainless Steel	
– Ferritic/Martensitic	7.75
– Austenitic	7.92
Copper	8.90
Brass	8.47
Bronze	8.89
INCOLOY® Alloy 800	7.95
INCOLOY® Alloy 800H	7.95
INCOLOY® Alloy 825	8.14
INCOLOY® Alloy 903	8.14
INCOLOY® Alloy DS	7.92
INCONEL® Alloy 600	8.42

Material	Density Kg/dm ³
INCONEL® Alloy 601	8.06
INCONEL® Alloy 617	8.36
INCONEL® Alloy 625	8.44
INCONEL® Alloy 690	8.19
INCONEL® Alloy 718	8.19
INCONEL® Alloy X-750	8.25
MONEL Alloy 400	8.83
MONEL Alloy K-500	8.46
Nickel 200	8.89
Nickel 201	8.89
UNS 31803	7.80
17-4 PH	7.75

Comparative Densities

Material	Density Kg/dm ³
Stainless Steel	1.000
Stainless Steel – Ferritic and Martensitic	0.977
Mild and Carbon Steel	0.994
Low Alloy Steel	0.987
Aluminium	0.341
Copper	1.134
Brass	1.066
Aluminium Bronze	0.970
Titanium	0.571
Lead	1.440



INCOLOY and INCONEL are both registered trademarks of SMC

AALCO SERVICE CENTRES

ABERDEEN

Unit 9B, Peterseat Drive
Peterseat Park, Altens
Aberdeen AB12 3HT
Tel: 01224 854810
Fax: 01224 871982
e-mail: aberdeen@aalco.co.uk

AYLESBURY

Unit 1, Premus
Coldharbour Way, Aylesbury
Buckinghamshire HP19 8AP
Tel: 01296 461700
Fax: 01296 339923
e-mail: aylesbury@aalco.co.uk

BELFAST

The Belfast Metal Centre
20 McKinney Road
Newtownabbey
County Antrim BT36 4PE
Tel: 02890 838838
Fax: 02890 837837
e-mail: belfast@aalco.co.uk

BIRMINGHAM

Shelah Road
Halesowen
West Midlands B63 3PH
Tel: 0121 585 3600
Fax: 0121 585 6864
e-mail: birmingham@aalco.co.uk

CHEPSTOW

Avenue West
Newhouse Park Estate
Chepstow
Monmouthshire NP16 6UD
Tel: 01291 638 638
Fax: 01291 638 600
e-mail: chepstow@aalco.co.uk

DYFED

Units 3-4
Capel Hendre Industrial Estate
Ammanford
Carmarthenshire SA18 3SJ
Tel: 01269 842044
Fax: 01269 845276
e-mail: dyfed@aalco.co.uk

ESSEX

Unit 2 Carnival Park
Festival Way
Basildon
Essex, SS14 3WN
Tel: 01268 884200
Fax: 01268 884220
e-mail: essex@aalco.co.uk

GLASGOW

117 Clydesmill Place
Cambuslang Investment Park
Glasgow G32 8RF
Tel: 0141 646 3200
Fax: 0141 646 3260
e-mail: glasgow@aalco.co.uk

HULL

Saxon Way
Priory Park West
Hessle
Hull HU13 9PB
Tel: 01482 626262
Fax: 01482 626263
e-mail: hull@aalco.co.uk

LEEDS

Unit 1
Revie Road off Elland Road
Leeds LS11 8JG
Tel: 0113 276 3300
Fax: 0113 276 0382
e-mail: leeds@aalco.co.uk

LIVERPOOL

207 Great Howard Street
Liverpool L5 9ZH
Tel: 0151 207 3551
Fax: 0151 207 2657
e-mail: liverpool@aalco.co.uk

MANCHESTER

Express Trading Estate
Stone Hill Road
Farnworth
Bolton BL4 9NN
Tel: 01204 863456
Fax: 01204 863430
e-mail: manchester@aalco.co.uk

NEWCASTLE

First Avenue
Team Valley Trading Estate
Gateshead, Tyne & Wear
NE11 0NU
Tel: 0191 491 1133
Fax: 0191 491 1177
e-mail: newcastle@aalco.co.uk

NORWICH

Roundtree Way
Mousehold Lane
Norwich NR7 8SR
Tel: 01603 787878
Fax: 01603 789999
e-mail: norwich@aalco.co.uk

NOTTINGHAM

Harrimans Lane
Dunkirk
Nottingham NG7 2SD
Tel: 0115 988 2600
Fax: 0115 988 2636
e-mail: nottingham@aalco.co.uk

SOUTHAMPTON

Test Lane, Nursling
Southampton SO16 9TA
Tel: 02380 875200
Fax: 02380 875275
e-mail: southampton@aalco.co.uk

STOKE

Unit F, Forge Way
Brown Lees Industrial Est
Biddulph
Stoke-on-Trent ST8 7DN
Tel: 01782 375700
Fax: 01782 375701
e-mail: stoke@aalco.co.uk

SWANLEY

Unit 7
Pedham Place Industrial Estate
Wested Lane,
Swanley
Kent BR8 8TE
Tel: 01322 610900
Fax: 01322 610910
e-mail: swanley@aalco.co.uk

www.aalco.co.uk

aalco[®]